

MX-0808-SCL



User Manual

v1.0.0

Contents

- Contents**..... 2
- Overview**..... 3
- Features**..... 3
- Package Contents**..... 3
- Specifications**..... 4
- Panel Description**..... 6
- Installation**..... 8
- Wiring Diagram**..... 8
- Front Panel Control**..... 9
- Accessing the WebUI**..... 10
- Video Routing**..... 12
- Audio Routing**..... 12
- Display Control**..... 13
- General Settings**..... 14
- A/V Configuration**..... 15
- Audio Output Settings:**..... 18
- Advanced Settings:**..... 19

Overview

This product boasts a cutting-edge 8 x 8 HDMI matrix featuring seamless switching capabilities, enhanced by 4K60 scalers integrated into each HDMI output. It is equipped with a versatile USB-C input that supports AV, 1G network connections, and PD 3.0 host charging with a capacity of up to 60W.

Moreover, it offers the flexibility of independent audio routing from eight inputs to four analog outputs. Designed with versatility in mind, it is suitable for both 1U rackmount and stand-alone setups. This product is an ideal 4K A/V switching and distribution solution for professional settings, including corporate training environments, hotel conference rooms, and university lecture halls, ensuring high-quality, reliable multimedia performance.

Features

- 7 x HDMI inputs, 1 x USB-C input, 8 x HDMI outputs
- All inputs and outputs support resolutions up to 4K@60Hz 4:4:4 8bit.
- Supports HDCP 2.3 and backwards compatible.
- Each HDMI output has a 4K60 scaler built-in and supports scaling output resolutions from 480p to 2160p.
- Seamless switching between HDMI inputs and outputs.
- USB-C input port supports 4K@60Hz, 1G network, and PD 3.0 host laptop charging up to 60W.
- Supports independent audio switching:
- Provides audio de-embedding of 1 x USB-C and 7 x HDMI inputs, and each input supports sampling frequencies up to 192KHz.
- Supports 4 x analog line audio outputs.
- Supports independent switching between de-embedding audio and analog line audio outputs.
- Multiple control options, including front panel buttons, RS-232 and LAN (WebUI and Telnet)

Package Contents

- 1 x Matrix Switcher
- 1 x AC Power Cord with US Pins
- 1 x AC Power Cord with EU Pins
- 1 x AC Power Cord with AU Pins
- 1 x AC Power Cord with UK Pins
- 1 x 2m USB 3.1 Type-C Cable (5Gbps per lane)
- 1 x 3.5mm 3-Pin Phoenix Male Connector
- 4 x 3.5mm 5-Pin Phoenix Male Connector
- 2 x 1U Rack Mounting Brackets
- 8 x M3*L7 Mounting Screws
- 1 x Quick Start Guide

Specifications

Technical

Input/Output Ports	1 x USB-C, 7 x HDMI
Input/Output Video Type	4K@60Hz 4:4:4 8bit, HDCP 2.3
Input/Output Resolution Supported	VESA: 800x600 ⁸ , 1024x768 ⁸ , 1280x768 ⁸ , 1280x800 ⁸ , 1280x960 ⁸ , 1280x1024 ⁸ , 1360x768 ⁸ , 1366x768 ⁸ , 1440x900 ⁸ , 1600x900 ⁸ , 1600x1200 ⁸ , 1680x1050 ⁸ , 1920x1200 ⁸ SMPTE: 720x576P ⁶ , 1280x720P ^{6,7,8} , 1920x1080P ^{2,5,6,7,8} , 3840x2160 ^{2,3,5,8} (4:2:0 8bit only), 4096x2160 ^{2,3,5,8} (4:2:0 8bit only) 2 = at 24 Hz, 3 = at 25 Hz, 5 = at 30 Hz, 6 = at 50 Hz, 7 = at 59.94 Hz, 8 = 60 Hz
Audio Format	USB-C/HDMI/LINE OUT: PCM 2.0
Maximum Data Rate	HDMI: 18Gbps USB-C: 5Gbps (per lane)
Control Method	Front panel buttons, IR, RS232, LAN (Telnet API & Web UI)

General

Operating Temperature/RH	0°C ~ 45°C (32°F ~ 113°F)
Storage Temperature/RH	-20°C ~ 70°C (-4°F ~ 158°F)
Humidity	10% ~ 90%, non-condensing
ESD Protection	Human-body model: ±8kV (air-gap discharge)/ ±4kV (contact discharge)
Power Supply	AC 100-240V 50/60Hz
Power Consumption (max)	TBD
Dimensions (W x H x D)	Matrix: 440mm x 43.5mm x 330mm/17.32" x 1.71" x 12.99" (Without mounting brackets)
Weight	4.68kg/10.3lbs
Rack Space Required	Matrix: 1U

Transmission Distance

USB Type-C	2m/7ft	4K@60Hz 4:4:4 24bpp
HDMI	Input/Output: 15m/49ft	1080P@60Hz 24bpp
	Input/Output: 5m/16ft	4K@60Hz 4:4:4 24bpp

Panel Description

Matrix

Front Panel

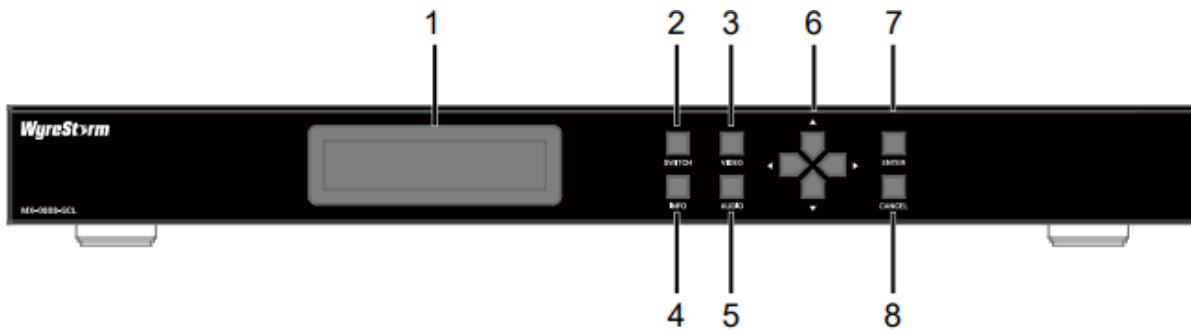

1	LCD Screen	Displays information for operation
2	Switch	Enters input channel selection
3	Video	Displays the video information of the selected input when pressed including Resolution, Color Space, and HDCP Status
4	Info	Displays the device's information including IP address, Fan Speed, Version numbers and temperature when pressed
5	Audio	Enters volume adjust mode when pressed
6	Selection Buttons	<p>INFO: Press the four selection buttons to turn the page to display the information.</p> <p>AUDIO: Press the left/right button to switch audio output ports and the up/down button to increase/decrease volume.</p> <p>SWITCH: Press the left/right button to switch output and the up/down button to select the input for the selected output.</p> <p>VIDEO: Press the left/right button to switch input port and the up/down button to turn the page to display video information.</p>
7	Enter	Confirms button operation when pressed
8	Cancel	Cancels the button operation or exits current mode when pressed

Rear Panel

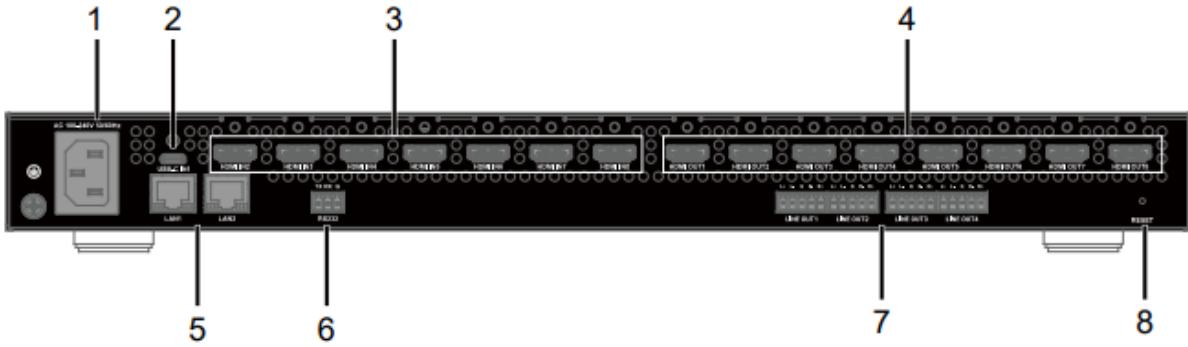

1	AC 100~240V 50/60Hz	Connect to power source using the AC power cord provided.
2	USB-C IN 1	<p>USB 3.0 Type-C port; connect to a USB C Device.</p> <p>It provides the following functions:</p> <ul style="list-style-type: none"> • Supports audio, video and USB 3.0 (data rate up to 5Gbps) / 2.0 transmission. • Charges the USB-C source (that supports USB PD 3.0) up to 60W. • Supports 1GbE connection for the connected laptop to access 1G network. <p>Tip: A USB Type-C to Type-C cable (USB 3.0 or above) is recommended</p>
3	HDMI IN 2-8	Connect to HDMI sources.
4	HDMI OUT 1-8	Connect to HDMI displays.
5	LAN 1-2	Connect to Ethernet devices for LAN control (Web UI/Telnet).
6	RS232	Connect to an RS232 device for bi-directional serial communication.
7	LINE OUT 1-4	Connect to audio system.
8	RESET	<p>Reset button. Use a pointed stylus to press and hold the recessed button for the following:</p> <p>(1) Less than 5 seconds: Nothing will happen.</p> <p>(2) 5 to 15 seconds: Reset the IP addressing mode of the device to DHCP and the login passwords of telnet-TLS session & web UI to factory defaults.</p> <ul style="list-style-type: none"> • Tip: The default login password for telnet-TLS session is "wyrestorm" and for web UI is "admin". <p>(3) More than 15 seconds: Reset the device to factory defaults.</p>

Installation

Note: Before installation, please ensure the kit is disconnected from the power source.

The matrix occupies 1U space and can be placed on a solid and stable surface or installed on a standard equipment rack.

1. Position and secure the rack mounting brackets to the panels on two sides with screws (four on each side) provided.

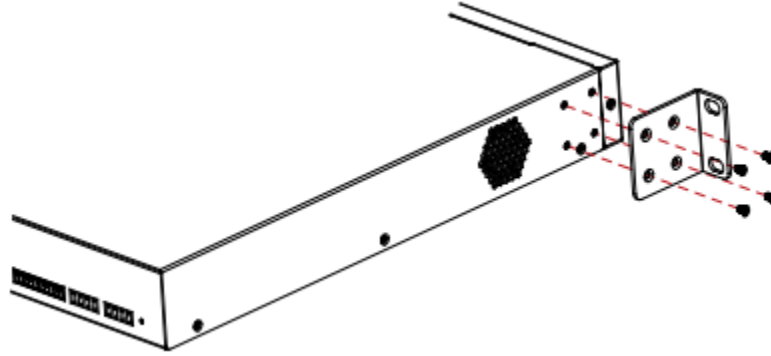

2. Screw the unit to the equipment rack (screws are not included in the package).

Wiring Diagram

Warnings:

- Before wiring, disconnect the power from all devices.
- During wiring, connect and disconnect the cables gently.

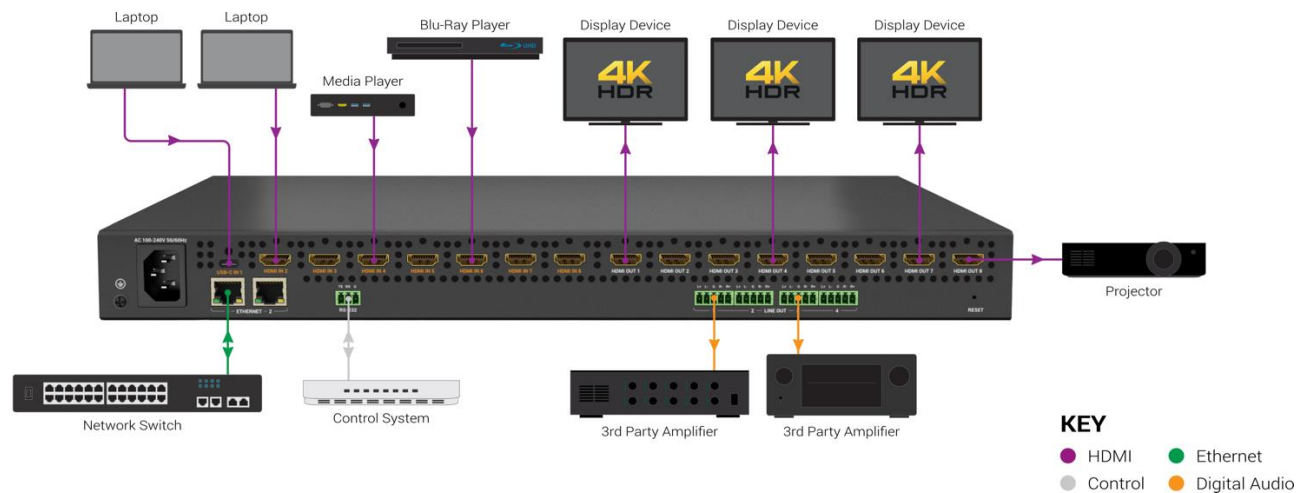

Front Panel Control

Front panel buttons of the matrix can be used to switch input sources to output displays, Audio volume adjustment and obtain device information.

Power on the device, the LCD window shows "Starting...", followed by the device's model No. and IP address, indicating that the device is ready for operation.

Switch Input Sources to Output Displays

To select input source for output display:

1. Press "Switch" to enter the input/output selection mode.
2. Press the Left (◀) or Right (▶) button to select output channel. The icon moves to show the selected output channel.

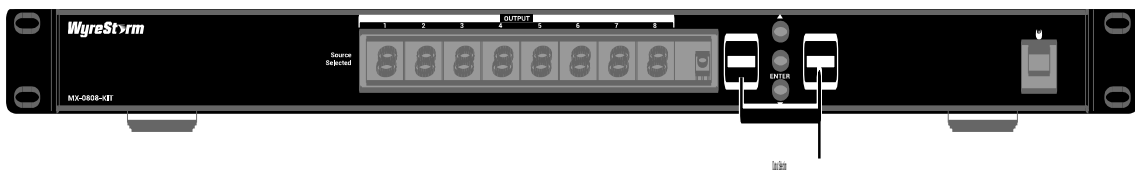

3. Press the Up (▲) or Down (▼) button to select input channel.

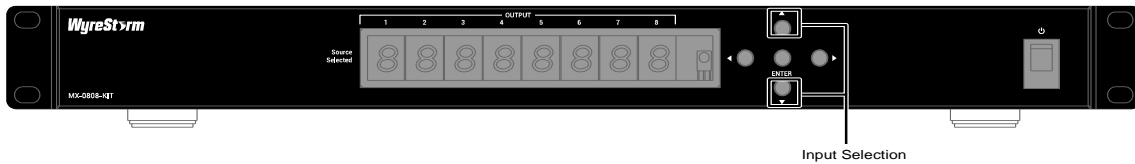

4. Press the "ENTER" button to confirm the selection or "Cancel" button to return to the main page.

Audio Volume Adjustment

1. Press "AUDIO" to enter volume adjustment mode.
2. Press the Left (◀) or Right (▶) button to select audio output port number from 1 to 4.
3. Press the Up (▲) or Down (▼) button to adjust volume of the selected channel from 0dB to -99dB, or mute.
4. Press "CANCEL" to exit current mode and return to the main page.

Viewing Device Information

- 1) Press "INFO" button to enter device information display mode.
- 2) Press the Left(◀) or Right (▶) Up (▲) or Down (▼) button to view the display information.
- 3) Press "CANCEL" button to exit the current mode and return to the main page.

RS232

Advanced users may need to control the kit through RS232 serial communication. Connect a control PC or control system to the RS232 port of the matrix. API command for RS232 control is available in the separate document. A professional RS232 serial interface software (e.g. Serial Assist) may be needed as well.

Before executing the API command through RS232 serial connection, please ensure RS232 interface of the device and the control PC are configured correctly.

Baud Rate	9600 bps
Data bits	8 bits
Parity	None
Stop bits	1 bit
Flow control	None

Telnet

By default, Telnet protocol is enabled on the matrix. Before sending commands to the LAN port of the matrix through telnet, establish a telnet session between it and the PC.

- IP: The device's IP address.
- port: The device's port number, this is not required for some telnet client tools. The default port number is 23.

Accessing the WebUI

The Web UI is an intuitive software interface for users to manage and control the device with ease through a browser. A Chrome, Safari, Microsoft Edge, or Firefox browser is recommended.

By default, the device's IP addressing mode is DHCP.

To access the Web UI:

1. Connect either the LAN 1 or LAN 2 port of the device to local area network. Ensure there's a DHCP server in the network so that the device can obtain a valid IP address. The allocated IP address can be checked through the LCD screen menu.

Tip: Another simple way to obtain the IP address is to send the command "GET IPADDR<CR><LF>" to the device through the RS232 port.

2. Connect a PC to the same network as the device.
3. Input the device's IP address in the browser and press Enter, the following page appears.



Matrix Control Login

User: To log on as a user, you can access the Matrix Control tab only for basic video and audio settings. Click User to enter the web UI directly and no login password is required.

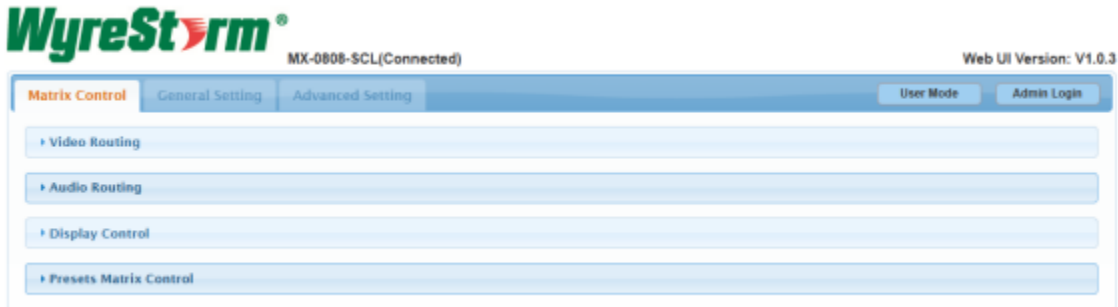

Admin: To log on as an administrator, you are granted with full privileges to configure the matrix system. Select **Admin**, type the password (default password is **admin**) in the Admin Password field and press Enter.



Matrix Control Login

Admin Password:

Input a new password in the following pop-up window and click **Apply** to enter the main page. The password must be alphanumeric and 4 to 16 characters in length.

Change Password

Please change your password to continue

Note: Password must be 4 to 16 characters in length, alphanumeric only.

Video Routing

Video Routing									
Source/Zone	OUTPUT 1	OUTPUT 2	OUTPUT 3	OUTPUT 4	OUTPUT 5	OUTPUT 6	OUTPUT 7	OUTPUT 8	All
input 1	<input checked="" type="checkbox"/>	<input type="checkbox"/>	<input type="checkbox"/>	<input type="checkbox"/>	<input type="checkbox"/>	<input type="checkbox"/>	<input type="checkbox"/>	<input type="checkbox"/>	<input type="checkbox"/>
input 2	<input type="checkbox"/>	<input checked="" type="checkbox"/>	<input type="checkbox"/>	<input type="checkbox"/>	<input type="checkbox"/>	<input type="checkbox"/>	<input type="checkbox"/>	<input type="checkbox"/>	<input type="checkbox"/>
input 3	<input type="checkbox"/>	<input type="checkbox"/>	<input checked="" type="checkbox"/>	<input type="checkbox"/>	<input type="checkbox"/>	<input type="checkbox"/>	<input type="checkbox"/>	<input type="checkbox"/>	<input type="checkbox"/>
input 4	<input type="checkbox"/>	<input type="checkbox"/>	<input type="checkbox"/>	<input checked="" type="checkbox"/>	<input type="checkbox"/>	<input type="checkbox"/>	<input type="checkbox"/>	<input type="checkbox"/>	<input type="checkbox"/>
input 5	<input type="checkbox"/>	<input type="checkbox"/>	<input type="checkbox"/>	<input type="checkbox"/>	<input checked="" type="checkbox"/>	<input type="checkbox"/>	<input type="checkbox"/>	<input type="checkbox"/>	<input type="checkbox"/>
input 6	<input type="checkbox"/>	<input type="checkbox"/>	<input type="checkbox"/>	<input type="checkbox"/>	<input type="checkbox"/>	<input checked="" type="checkbox"/>	<input type="checkbox"/>	<input type="checkbox"/>	<input type="checkbox"/>
input 7	<input type="checkbox"/>	<input type="checkbox"/>	<input type="checkbox"/>	<input type="checkbox"/>	<input type="checkbox"/>	<input type="checkbox"/>	<input checked="" type="checkbox"/>	<input type="checkbox"/>	<input type="checkbox"/>
input 8	<input type="checkbox"/>	<input type="checkbox"/>	<input type="checkbox"/>	<input type="checkbox"/>	<input type="checkbox"/>	<input type="checkbox"/>	<input type="checkbox"/>	<input checked="" type="checkbox"/>	<input type="checkbox"/>
None	<input type="checkbox"/>	<input type="checkbox"/>	<input type="checkbox"/>	<input type="checkbox"/>	<input type="checkbox"/>	<input type="checkbox"/>	<input type="checkbox"/>	<input type="checkbox"/>	<input type="checkbox"/>

This section manages selections between the input video sources and output displays.

Click the button in the table to select an input for a certain output display (button turns from white to blue once selection is done).

- **All:** Click to route a certain input to all outputs.
- **None:** Click to deselect the input for a certain output.

By default, Video Input 1 routes to Output 1, Video Input 2 routes to Output 2 and so on.

Audio Routing

This section manages the audio routing mode and selection between the input audio sources and line out ports. The default setting is "Follow Video".

- **Follow Video:** In this mode, LINE OUT 1-4 follow the input channel selection of video outputs 1-4.
- **Independent Switching:** In this mode, you are able select a desired audio input for a certain LINE OUT port manually, which will be independent of the settings in Video Routing section. In Independent Switching mode, click the button in the table to select an audio input for a certain output (button turns from white to blue once selection is done).
- **All:** Click to route a certain audio input to all LINE OUT ports.

Audio Routing

Follow Video
 Independent Switching

Source/Zone	LINE OUT1	LINE OUT2	LINE OUT3	LINE OUT4	All
INPUT 1	<input checked="" type="checkbox"/>	<input type="checkbox"/>	<input type="checkbox"/>	<input type="checkbox"/>	<input type="checkbox"/>
INPUT 2	<input type="checkbox"/>	<input checked="" type="checkbox"/>	<input type="checkbox"/>	<input type="checkbox"/>	<input type="checkbox"/>
INPUT 3	<input type="checkbox"/>	<input type="checkbox"/>	<input checked="" type="checkbox"/>	<input type="checkbox"/>	<input type="checkbox"/>
INPUT 4	<input type="checkbox"/>	<input type="checkbox"/>	<input type="checkbox"/>	<input checked="" type="checkbox"/>	<input type="checkbox"/>
INPUT 5	<input type="checkbox"/>	<input type="checkbox"/>	<input type="checkbox"/>	<input type="checkbox"/>	<input type="checkbox"/>
INPUT 6	<input type="checkbox"/>	<input type="checkbox"/>	<input type="checkbox"/>	<input type="checkbox"/>	<input type="checkbox"/>
INPUT 7	<input type="checkbox"/>	<input type="checkbox"/>	<input type="checkbox"/>	<input type="checkbox"/>	<input type="checkbox"/>
INPUT 8	<input type="checkbox"/>	<input type="checkbox"/>	<input type="checkbox"/>	<input type="checkbox"/>	<input type="checkbox"/>

Display Control

This section provides configuration of CEC control on output displays.

Display Control

CEC Control

Zone	Manual	Auto	Delay(1-30min)	Command Setting
OUTPUT 1	Display On Display Off	<input checked="" type="checkbox"/>	2	⌂
OUTPUT 2	Display On Display Off	<input checked="" type="checkbox"/>	2	⌂
OUTPUT 3	Display On Display Off	<input checked="" type="checkbox"/>	2	⌂
OUTPUT 4	Display On Display Off	<input checked="" type="checkbox"/>	2	⌂
OUTPUT 5	Display On Display Off	<input checked="" type="checkbox"/>	2	⌂
OUTPUT 6	Display On Display Off	<input checked="" type="checkbox"/>	2	⌂
OUTPUT 7	Display On Display Off	<input checked="" type="checkbox"/>	2	⌂
OUTPUT 8	Display On Display Off	<input checked="" type="checkbox"/>	2	⌂

- Display On:** Click to send the Display On command (predefined in the Command Setting dialog box) to the certain output display immediately.

- **Display Off:** Click to send the Display Off command (predefined in the Command Setting dialog box) to the certain output display immediately.
- **Auto:** Toggle to turn on/off the automatic CEC control function. If Auto is turned on, the corresponding output port sends Display Off command to the connected display automatically when it detects no valid signal input within the predefined Delay time.

Default setting: On

- **Delay (1-30min):** Define the delay time for the output port to automatically send Display Off command to the connected display when no signal is present. For example, if the Delay is set to 2 minutes, the output display will automatically power off when there's no signal at the display in 2 minutes.

NOTE: The default setting is 2 minutes

Command Setting

Click the icon to open the Command Setting dialog box:

Command Testing	<input type="text"/>	Test
Display On	40 04	Save
Display Off	40 36	Save

- **Command Testing:** Input a command and click Send to test if it sends out the command to the connected display successfully.
- **Display On/Off:** Type the defined CEC command for controlling display on/off and click Save.

NOTE: Default setting for Display On command is "40 04", for Display Off command is "40 36".

General Settings

The General Setting tab includes two submenus: A/V Configuration and Audio Output Settings.

A/V Configuration

A/V Configuration

Source

1	INPUT 1	2	INPUT 2
3	INPUT 3	4	INPUT 4
5	INPUT 5	6	INPUT 6
7	INPUT 7	8	INPUT 8

Zone

1	OUTPUT 1	2	OUTPUT 2
3	OUTPUT 3	4	OUTPUT 4
5	OUTPUT 5	6	OUTPUT 6
7	OUTPUT 7	8	OUTPUT 8

Input 1 Name

INPUT 1

EDID

Fixed 4K30 2.0CH PCM Audio with SDR

Apply

Save EDID

Video In

Video Details			
Resolution	0x0	Frame Rate	0
HDR Info	None	Color Space	None
Deep Color	None	HDCP Version	None

Audio In

Audio Details			
Format	None	Sampling Rate	0kHz

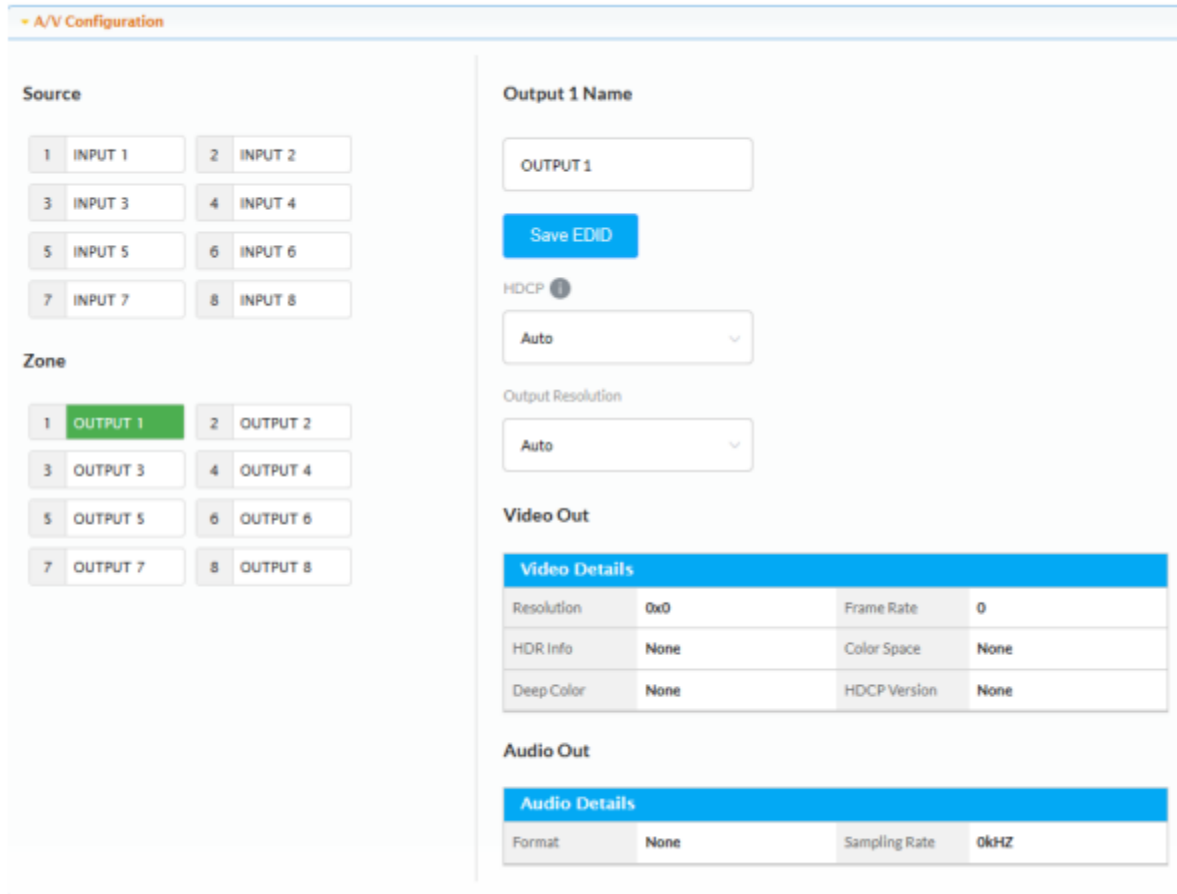

This section manages alias name, input EDID, output HDCP support and displays video and audio detailed information for the input/output ports.

For input ports 1-8:

- Source: To select an input/output port.
- Input Name (1~8): Input a new alias name for the selected input/output.
- EDID (Input 1-8): Select EDID for the corresponding input port and click Apply.

Note: Default EDID for Input 1 is Fixed 4K30 2.0CH PCM Audio with SDR and for Input 2-8 is Fixed 4K60 2.0CH PCM Audio with HDR.

EDID Options include the following:

- Copy form HDMI Output 1
- Copy form HDMI Output 2
- Copy form HDMI Output 3

- Copy form HDMI Output 4
- Copy form HDMI Output 5
- Copy form HDMI Output 6
- Copy form HDMI Output 7
- Copy form HDMI Output 8
- Fixed 4K60 2.0CH PCM Audio with HDR
- Fixed 4K60 2.0CH PCM Audio with SDR
- Fixed 4K30 2.0CH PCM Audio with HDR
- Fixed 4K30 2.0CH PCM Audio with SDR
- Fixed 1080p@60Hz 2.0CH PCM Audio with HDR
- Fixed 1080p@60Hz 2.0CH PCM Audio with SDR
- EDID Write

For EDID Write, click Apply > UPLOAD FILE to select an EDID file from your computer to have it imported to the matrix.



- Video Details: Displays the input port's video information.
- Audio Details: Displays the input port's audio information.

For output ports 1-8:

- Zone: To select an output port.
- Output Name (1~8): Input a new alias name for the selected input/output.
- Save EDID: To download the EDID information of the select input port as a bin file to the PC.
- HDCP: To configure the HDCP support function.
 - Auto: To allow the selected output port to perform HDCP setting automatically.
 - HDCP v1.x: To set the output port to HDCP 1.4 encryption.

Default setting: Auto

- **Output Resolution:** To configure output resolution for the selected output port.
 - **Auto:** To allow the output port to select the most appropriate output resolution automatically based on reading the attached display's EDID.
 - **Resolution list:** To select a fixed resolution for the output port.

NOTE: Default setting: Auto

- Video Details: Displays the output port's video information.
- Audio Details: Displays the output port's audio information.

Audio Output Settings:

This section manages the audio properties of the LINE OUT ports (1-4), including the output audio volume, and toggle switch between mute and unmute.



- The output volume of LINE OUT 1-4 ranges from -100dB to 0dB, and can be turned up and down via the buttons. The default output audio volume is 0dB.
- The toggle switch is provided for switching between mute and unmute of the audio output. The default audio output status is unmuted.

Advanced Settings:

The Advanced Setting includes the following submenus.

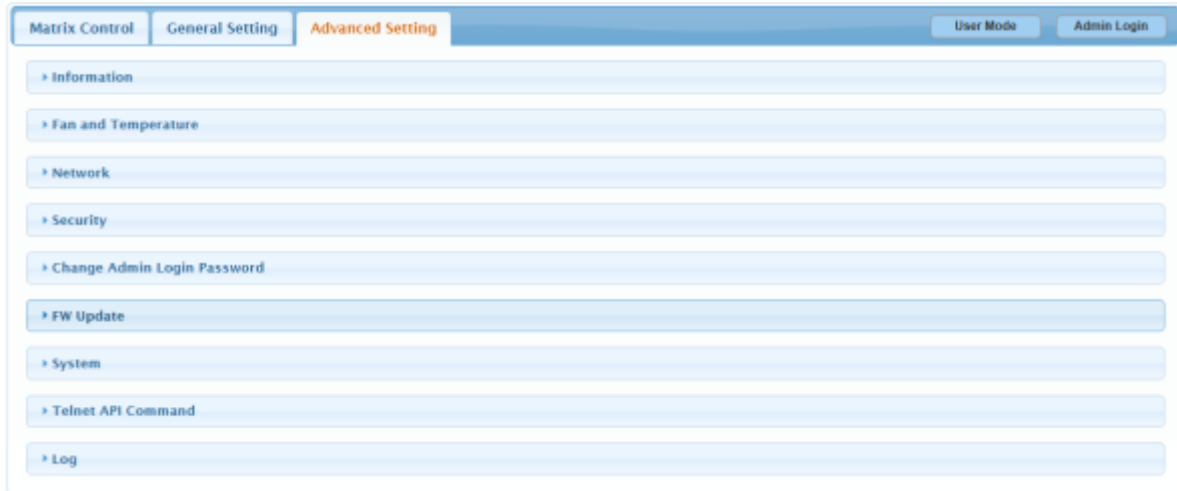

Information:

This section displays the device information, including Model number, physical address, IP address and firmware version.

Information		
MODEL	MAC ADDRESS	IP ADDRESS
MX-0808-SCL	00:6f:90:02:55:dd	192.168.5.129
FIRMWARE VERSION		
1.0.3		

Fan and Temperature:

This section shows the device's fan speed and temperature.

Fan and Temperature	
Fan Speeds	Temperatures(°C)
[4050,4050]	[45]

Network:

This section manages network settings.

Network

Mode

DHCP Static

Device IP Address

192.168.5.129

Subnet Mask

255.255.240.0

Device Gateway

192.168.2.1

Note: LAN Module will automatically reboot after changing Network setting.

Apply

IP Addressing mode:

- **DHCP:** When enabled, the IP address of the Matrix is assigned automatically by the DHCP server in the system.
- **Static:** When enabled, the IP address can be set manually.
 - Subnet Mask: Set subnet mask manually when Static is selected.
 - Device Gateway: Set gateway address manually to communicate with another network when Static is selected.

Default setting: DHCP

- **Apply:** Click to confirm your changes

Tips:

- When "Static" is selected, ensure your PC is in the same network segment as the Matrix.
- Please wait for 2-3 minutes for the Matrix to reboot after the network settings are changed.

Security:

This section manages the protocol settings of communication to the API channel on the matrix.

Security

Telnet over TLS	Disable
HTTPS	Enable

☒

- **Telnet over TLS:**

- **Disable:** When Telnet over TLS is disabled, telnet will be used for establishing an open and insecure connection to the matrix on port 23, which allows access to send and receive API commands from the computer or control system.
- **Enable:** When Telnet over TLS is enabled, it will be used for establishing an encrypted and secure connection to the matrix on port 24. Default username and password for TLS login are listed in the following table. You can optionally set a new password for logging on to the matrix through TLS.

	Telnet (Default)	Telnet over TLS
Port	23	24
Credentials	N/A	User: admin Default Password: wyrestorm

Note: The password to log on to the matrix through TLS must be alphanumeric with 4 to 16 characters in length.

Default setting: Disable

- **HTTPS:** HTTPS provides an encrypted and secure access to the matrix, and can be enabled or disabled as needed to meet application security requirements.
 - **Enable:** HTTPS will be used for providing an encrypted and secure access to the web server of the matrix.
 - **Disable:** HTTP will be used for providing an open and unencrypted access to the web server of the matrix.

Default setting: Enable

Change Admin Login Password:

This section is for changing admin login password. The default password is "admin".

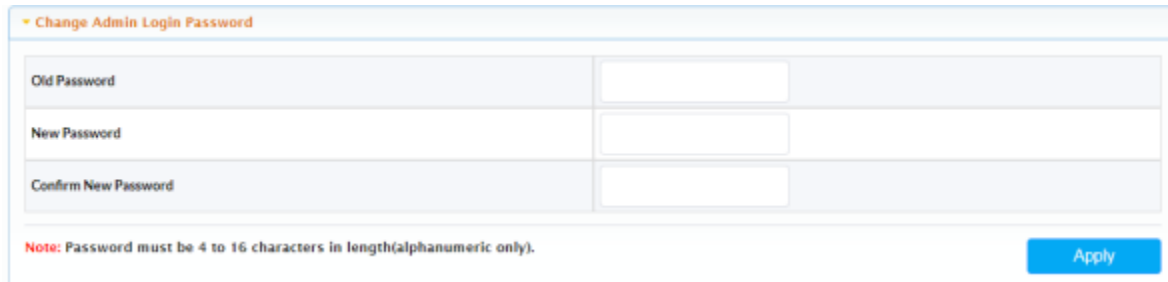

- **Apply:** Click to perform the setting.

Note: The password must be 4 to 16 characters in length (alphanumeric only).

FW Update:

This section is for updating the matrix firmware.

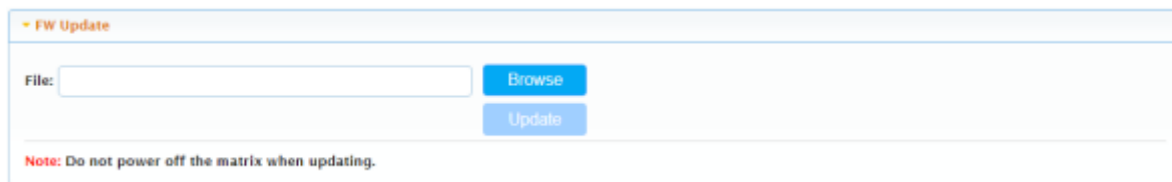

Steps for firmware update:

1. Contact WyreStorm Technical Support for the latest upgrade file.
2. Click "Browse" to select the upgrade file on your computer.
3. Click "Update" to proceed. The matrix reboots automatically after upgrading is completed.

Note: Do not power off the matrix during the upgrading

System:

This section allows basic system control including Reboot and Factory Reset of the device.

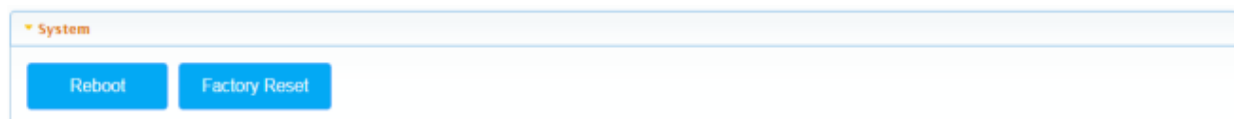

- **Reboot:** Click to reboot the device and wait for 2 minutes to log back in by refreshing the browser.
- **Factory Reset:** Click to reset the device to factory defaults and wait for 2 minutes to log back in by refreshing the browser.

Telnet API:

This section allows users to send telnet API commands to the matrix. The command response can be obtained in “Log” section.

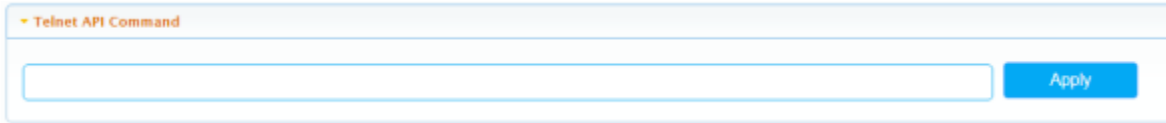

The screenshot shows a web interface for sending Telnet API commands. At the top, there is a tab labeled "Telnet API Command". Below the tab is a large, empty text input field. To the right of the input field is a blue button labeled "Apply".

Apply: Click to send the API command entered to the matrix.

For example, enter the telnet API `set sw in1 out7<CR><LF>` and click Apply, a response of `SW IN1 OUT7` will be displayed in the Log section as the following:

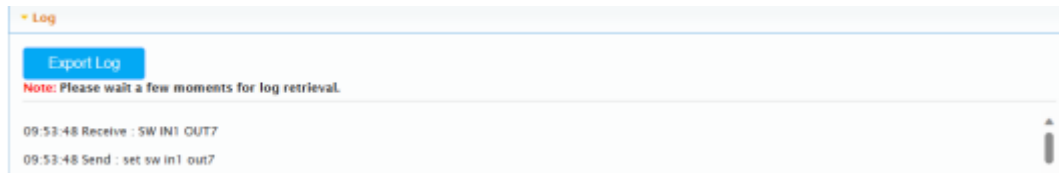

The screenshot shows the "Log" section of the interface. At the top, there is a tab labeled "Log". Below the tab is a blue button labeled "Export Log". Below the button is a red note: "Note: Please wait a few moments for log retrieval." Below the note is a scrollable log area containing the following text:

```
09:53:48 Receive : SW IN1 OUT7
09:53:48 Send : set sw in1 out7
```

Log:

This section displays the system log and command response.

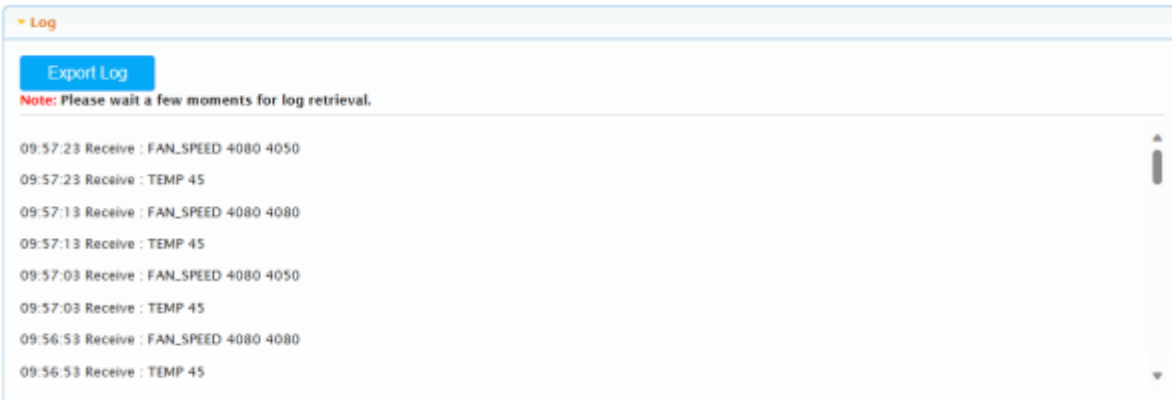

The screenshot shows the "Log" section of the interface. At the top, there is a tab labeled "Log". Below the tab is a blue button labeled "Export Log". Below the button is a red note: "Note: Please wait a few moments for log retrieval." Below the note is a scrollable log area containing the following text:

```
09:57:23 Receive : FAN_SPEED 4080 4050
09:57:23 Receive : TEMP 45
09:57:13 Receive : FAN_SPEED 4080 4080
09:57:13 Receive : TEMP 45
09:57:03 Receive : FAN_SPEED 4080 4050
09:57:03 Receive : TEMP 45
09:56:53 Receive : FAN_SPEED 4080 4080
09:56:53 Receive : TEMP 45
```

- **Export Log:** Click to export the log to the computer (used by our technical team for troubleshooting)