

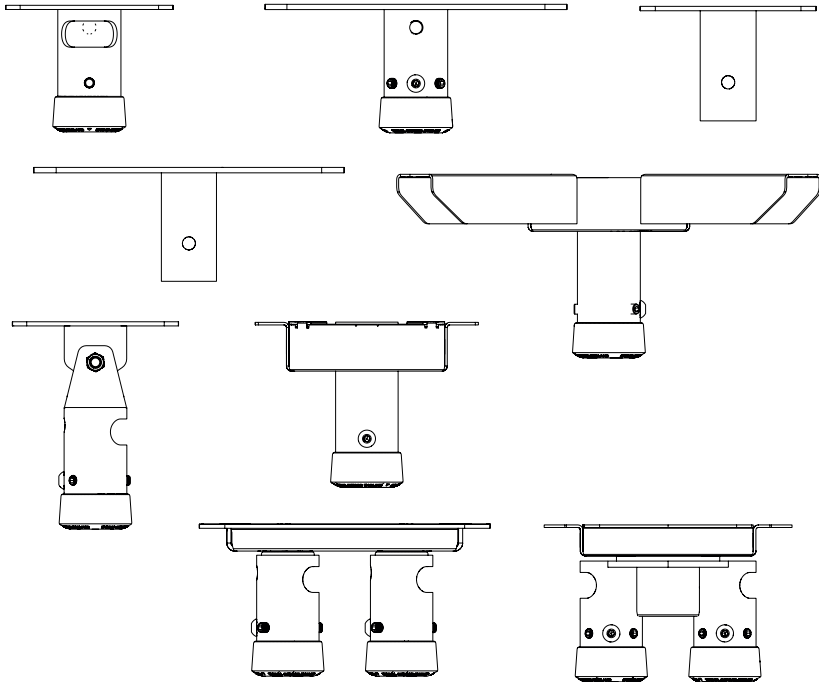

## CP1 / CP2 / CP3 / CP4 / CP5 / CP6 CP8 / CP9 / CPAV1



**Screen Size:** n/a | **Guide Max. Weight:** variable

\*Please check model specific details before installing\*

Revised 13/08/24

### WARNING

Please carefully inspect the product before assembling. If you notice any apparent damage, call your carrier claims agent and do not continue the installation until it has been reviewed. Please watch for pinch points. Do not put your fingers between moveable parts. Do not tamper with or disassemble any spring loaded parts. Before installing, make sure that the supporting surface will support five times the combined load of the solution and the hardware. Never exceed the maximum load capacity. Please also layout all components to ensure that you have all of the required parts before proceeding (see BOM list on following page). Use of this product for anything other than its specified use may result in failure or personal injury. This product is intended for indoor use only. We recommend using a qualified trades person for installation. Use an assistant or lifting equipment to lift and position products.

For support, please call: +44 (0)1865 767676 or email: sales@unicol.com



#	TOOLS REQUIRED
1	4mm & 5mm Allen Keys
2	Pozi Head Screwdriver
3	19mm Spanner
4	17mm Spanner

INSTALLERS REQUIRED
1

**COMPONENTS**

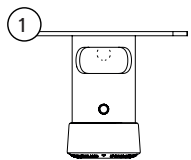

1

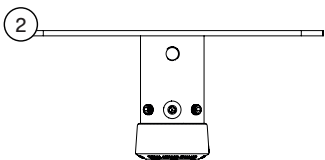

2

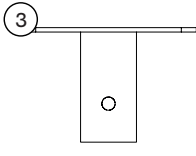

3

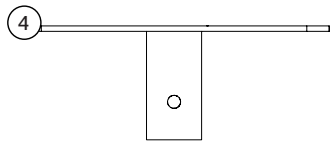

4

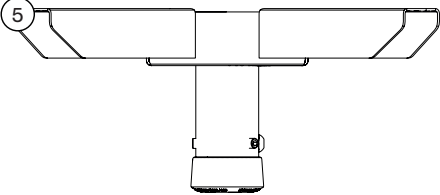

5

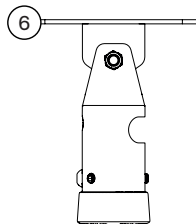

6

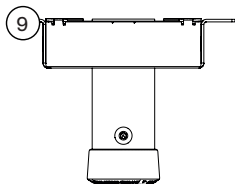

9

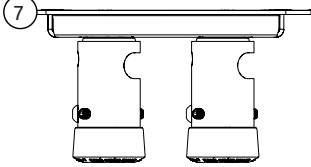

7

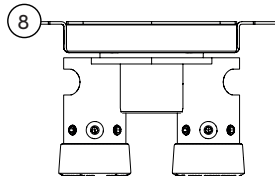

8

#	DESCRIPTION	QTY
1	CP1   Standard Ceiling Plate	-
2	CP2   Large Standard Ceiling Plate	-
3	CP3   Stub Column Ceiling Plate	-
4	CP4   Large Stub Column Ceiling Plate	-
5	CP5   Gantry Ceiling Plate	-
6	CP6   Tilting Ceiling Plate	-
7	CP8   Twin Column Ceiling Plate	-
8	CP9   Twin Column, Swivel Ceiling Plate	-
9	CPAV1   Anti-Vibration Ceiling Plate	-

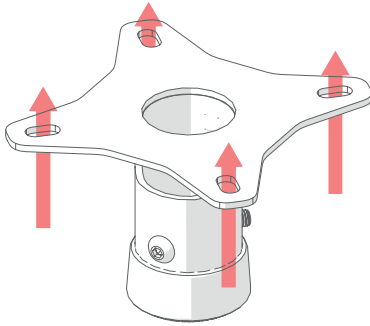

### STEP 1 (EXC. CP5 & CPSC1)

Using the 4 ceiling mounting slots, as shown above, determine where you want to install your mount, mark it and fix into position.

Please consider cabling and ceiling fixings prior to installation. Please check surface is capable of supporting 5x the combined solutions weight.

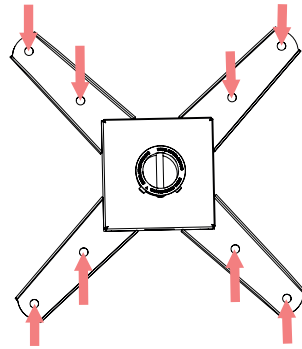

### STEP 1 (CP5)

Using the 8 ceiling mounting slots, as shown above, determine where you want to install your mount, mark it and fix into position.

Please consider cabling and ceiling fixings prior to installation. Please check surface is capable of supporting 5x the combined solutions weight.

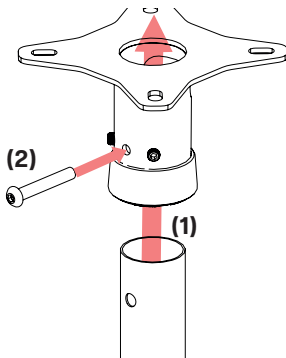

### STEP 2 (EXC. CP3 & CP4)

Slide all cabling through the column and through the gap in the ceiling plate socket. Being mindful of the cables, slide the column into the socket, ensuring that the two holes either side align with those on the mount. Using the through bolt, secure the column into place and tighten the two grub screws at the rear.

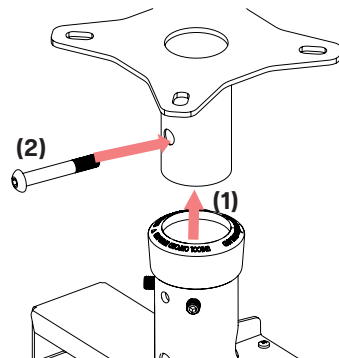

### STEP 2 (CP3 & CP4)

These plates fix directly with socket ended products such as suspension adaptors and PSU mounts.

Slide all cabling through the ceiling plate and attachment. Being mindful of the cables, slide the attachment over the stub column, ensuring that the two holes either side align. Using the through bolt, secure the column into place and tighten the two grub screws at the rear.

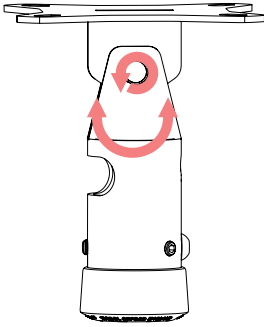

### CP6 TILT ADJUST

To adjust the angle of the CP6, slightly loosen the connecting bolt and move the socket to the correct angle. Once set, tighten the bolt to secure.

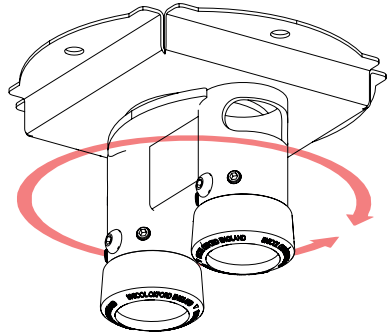

### CP9 SWIVEL ADJUST

The CP9 offers 360° swivel as standard. When it arrives it will have been tightened with an impact gun, making it stiff to move (to prevent unauthorised movement). To twist as desired, we recommend fitting the columns first.