



DLP® Projector

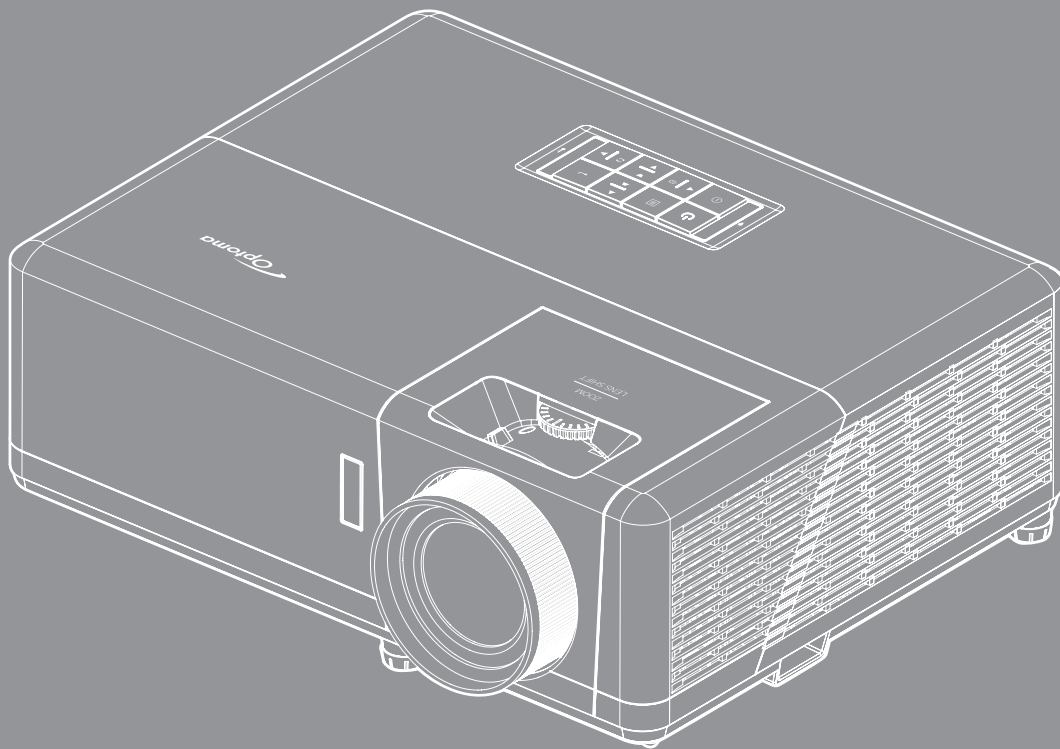

TABLE OF CONTENTS

SAFETY	4
<i>Important Safety Instruction</i>	4
<i>Laser Radiation Safety Information</i>	5
<i>Cleaning the Lens</i>	6
<i>3D Safety Information</i>	6
<i>Copyright</i>	7
<i>Disclaimer</i>	7
<i>Trademark Recognition</i>	7
<i>FCC</i>	8
<i>Declaration of Conformity for EU countries</i>	8
<i>WEEE</i>	8
INTRODUCTION	9
<i>Package Overview</i>	9
<i>Standard accessories</i>	9
<i>Optional accessories</i>	9
<i>Product Overview</i>	10
<i>Connections</i>	11
<i>Keypad</i>	12
<i>Remote control</i>	13
SETUP AND INSTALLATION	14
<i>Installing the projector</i>	14
<i>Connecting sources to the projector</i>	16
<i>Adjusting the projector image</i>	17
<i>Remote setup</i>	18
USING THE PROJECTOR	20
<i>Powering on / off the projector</i>	20
<i>Selecting an input source</i>	23
<i>Home screen overview</i>	24
<i>System date and time</i>	24
<i>Projector settings menu (OSD)</i>	25
<i>OSD Menu tree</i>	26
<i>Display menu</i>	32
<i>Audio menu</i>	38
<i>Setup menu</i>	39
<i>Info menu</i>	42
<i>System settings menu</i>	43
<i>Selecting an input source</i>	50
<i>Selecting an app</i>	51
<i>Supported multimedia formats</i>	55

<i>Viewing the status bar</i>	59
<i>Alexa / Google Assistant</i>	59

ADDITIONAL INFORMATION..... 60

<i>Compatible resolutions</i>	60
<i>Image size and projection distance</i>	65
<i>Projector dimensions and ceiling mount installation</i>	66
<i>IR remote codes</i>	67
<i>Troubleshooting</i>	68
<i>Warning indicators</i>	69
<i>Specifications</i>	72
<i>Optoma global offices</i>	73

SAFETY

	The lightning flash with arrow head within an equilateral triangle is intended to alert the user to the presence of uninsulated "dangerous voltage" within the product's enclosure that may be of sufficient magnitude to constitute a risk of electric shock to persons.
	The exclamation point within an equilateral triangle is intended to alert the user to the presence of important operating and maintenance (servicing) instructions in the literature accompanying the appliance.

Please follow all warnings, precautions and maintenance as recommended in this user's guide.

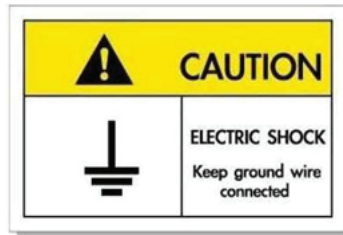

To avoid electric shock, the unit and its peripherals must be properly grounded (earthed).

Important Safety Instruction

- Do not block any ventilation openings. To ensure reliable operation of the projector and to protect from over heating, it is recommended to install the projector in a location that does not block ventilation. As an example, do not place the projector on a crowded coffee table, sofa, bed, etc. Do not put the projector in an enclosure such as a book case or a cabinet that restricts air flow.
- To reduce the risk of fire and/or electric shock, do not expose the projector to rain or moisture. Do not install near heat sources such as radiators, heaters, stoves or any other apparatus such as amplifiers that emits heat.
- Do not let objects or liquids enter the projector. They may touch dangerous voltage points and short out parts that could result in fire or electric shock.
- Do not use under the following conditions:
 - In extremely hot, cold or humid environments.
 - (i) Ensure that the ambient room temperature is within 5°C ~ 40°C
 - (ii) Relative humidity is 10% ~ 85%
 - In areas susceptible to excessive dust and dirt.
 - Near any appliance generating a strong magnetic field.
 - In direct sunlight.
- Do not use the unit if it has been physically damaged or abused. Physical damage/abuse would be (but not limited to):
 - Unit has been dropped.
 - Power supply cord or plug has been damaged.
 - Liquid has been spilled on to the projector.
 - Projector has been exposed to rain or moisture.
 - Something has fallen in the projector or something is loose inside.
- Do not place the projector on an unstable surface. The projector may fall over resulting in injury or the projector may become damaged.
- Do not block the light coming out of the projector lens when in operation. The light will heat the object and could melt, cause burns or start a fire.

- Please do not open or disassemble the projector as this may cause electric shock.
- Do not attempt to service the unit yourself. Opening or removing covers may expose you to dangerous voltages or other hazards. Please call Optoma before you send the unit for repair.
- See projector enclosure for safety related markings.
- The unit should only be repaired by appropriate service personnel.
- Only use attachments/accessories specified by the manufacturer.
- Do not look into straight into the projector lens during operation. The bright light may harm your eyes.
- When switching the projector off, please ensure the cooling cycle has been completed before disconnecting power. Allow 90 seconds for the projector to cool down.
- Turn off and unplug the power plug from the AC outlet before cleaning the product.
- Use a soft dry cloth with mild detergent to clean the display housing. Do not use abrasive cleaners, waxes or solvents to clean the unit.
- Disconnect the power plug from AC outlet if the product is not being used for a long period of time.
- *Do not setup the projector in places where it might be subjected to vibration or shock.*
- *Do not touch the lens with bare hands.*
- *Remove battery/batteries from remote control before storage. If the battery/batteries are left in the remote for long periods, they may leak.*
- *Do not use or store the projector in places where smoke from oil or cigarettes may be present, as it can adversely affect the quality of the projector performance.*
- *Please follow the correct projector orientation installation as non standard installation may affect the projector performance.*
- *Use a power strip and or surge protector. As power outages and brown-outs can KILL devices.*

Laser Radiation Safety Information

- This product is classified as CLASS 1 LASER PRODUCT - RISK GROUP 2 of IEC60825-1 : 2014 and also complies with 21 CFR 1040.10 and 1040.11 as a Risk Group 2, LIP (Laser Illuminated Projector) as defined in IEC 62471-5:Ed. 1.0. For more information see Laser Notice No. 57, dated May 8, 2019.

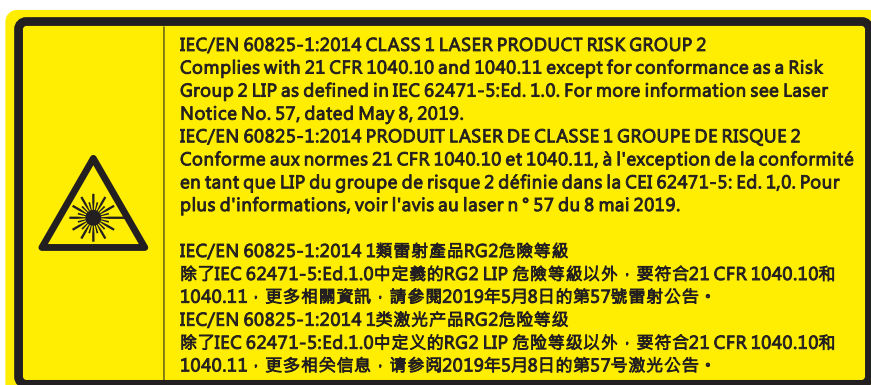

- As with any bright source, do not stare into the direct beam, RG2 IEC 62471-5:2015.
- This projector is class 1 laser product of IEC/EN 60825-1:2014 and risk group 2 with the requirements of IEC 62471-5:2015.

- Additional instructions to supervise children, no staring, and not use optical aids.
- Notice is given to supervise children and to never allow them to stare into the projector beam at any distance from the projector.
- Notice is given to use caution when using the remote control for starting the projector while in front of the projection lens.
- Notice is given to the user to avoid the use of optical aids such as binoculars or telescopes inside the beam.
- When turning on the projector, make sure no one within projection range is looking at the lens.
- Keep any items (magnifying glass etc.) out of the light path of the projector. The light path being projected from the lens is extensive, therefore any kind of abnormal objects that can redirect light coming out of the lens, can cause an unpredictable outcome such as a fire or injury to the eyes.
- Any operation or adjustment not specifically instructed by the user's guide creates the risk of hazardous laser radiation exposure.
- Do not open or disassemble the projector as this may cause damage by the exposure of laser radiation.
- Do not stare into beam when the projector is on. The bright light may result in permanent eye damage.

Without following the control, adjustment or operation procedure may cause damage by the exposure of laser radiation

Cleaning the Lens

- Before cleaning the lens, be sure to turn off the projector and unplug the power cord to allow it to completely cool down.
- Use a compressed air tank to remove the dust.
- Use a special cloth for cleaning lens and gently wipe the lens. Do not touch the lens with your fingers.
- Do not use alkaline/acid detergents or volatile solvents such as alcohol for cleaning lens. If the lens is damaged due to the cleaning process, it is not covered by the warranty.



Warning: Do not use a spray containing flammable gases to remove dust or dirt from the lens. This may cause a fire due to excessive heat inside the projector.



Warning: Do not clean the lens if the projector is warming up as this may cause the lens' surface film to peel off.



Warning: Do not wipe or tap the lens with a hard object.

3D Safety Information

Please follow all warnings and precautions as recommended before you or your child use the 3D function.

Warning

Children and teenagers may be more susceptible to health issues associated with viewing in 3D and should be closely supervised when viewing these images.

Photosensitive Seizure Warning and Other Health Risks

- Some viewers may experience an epileptic seizure or stroke when exposed to certain flashing images or lights contained in certain Projector pictures or video games. If you suffer from, or have a family history of epilepsy or strokes, please consult with a medical specialist before using the 3D function.
- Even those without a personal or family history of epilepsy or stroke may have an undiagnosed condition that can cause photosensitive epileptic seizures.
- Pregnant women, the elderly, sufferers of serious medical conditions, those who are sleep deprived or under the influence of alcohol should avoid utilizing the unit's 3D functionality.
- If you experience any of the following symptoms, stop viewing 3D pictures immediately and consult a medical specialist: (1) altered vision; (2) light-headedness; (3) dizziness; (4) involuntary movements

such as eye or muscle twitching; (5) confusion; (6) nausea; (7) loss of awareness; (8) convulsions; (9) cramps; and/ or (10) disorientation. Children and teenagers may be more likely than adults to experience these symptoms. Parents should monitor their children and ask whether they are experiencing these symptoms.

- Watching 3D projection may also cause motion sickness, perceptual after effects, disorientation, eye strain and decreased postural stability. It is recommended that users take frequent breaks to lessen the potential of these effects. If your eyes show signs of fatigue or dryness or if you have any of the above symptoms, immediately discontinue use of this device and do not resume using it for at least thirty minutes after the symptoms have subsided.
- Watching 3D projection while sitting too close to the screen for an extended period of time may damage your eyesight. The ideal viewing distance should be at least three times the screen height. It is recommended that the viewer's eyes are level with the screen.
- Watching 3D projection while wearing 3D glasses for an extended period of time may cause a headache or fatigue. If you experience a headache, fatigue or dizziness, stop viewing the 3D projection and rest.
- Do not use the 3D glasses for any other purpose than for watching 3D projection.
- Wearing the 3D glasses for any other purpose (as general spectacles, sunglasses, protective goggles, etc.) may be physically harmful to you and may weaken your eyesight.
- Viewing in 3D projection may cause disorientation for some viewers. Accordingly, DO NOT place your 3D PROJECTOR near open stairwells, cables, balconies, or other objects that can be tripped over, run into, knocked down, broken or fallen over.

Copyright

This publication, including all photographs, illustrations and software, is protected under international copyright laws, with all rights reserved. Neither this manual, nor any of the material contained herein, may be reproduced without written consent of the author.

© Copyright 2021

Disclaimer

The information in this document is subject to change without notice. The manufacturer makes no representations or warranties with respect to the contents hereof and specifically disclaims any implied warranties of merchantability or fitness for any particular purpose. The manufacturer reserves the right to revise this publication and to make changes from time to time in the content hereof without obligation of the manufacturer to notify any person of such revision or changes.

Trademark Recognition

Kensington is a U.S. registered trademark of ACCO Brand Corporation with issued registrations and pending applications in other countries throughout the world.

HDMI, the HDMI Logo, and High-Definition Multimedia Interface are trademarks or registered trademarks of HDMI Licensing LLC in the United States and other countries.

DLP®, DLP Link and the DLP logo are registered trademarks of Texas Instruments and BrilliantColor™ is a trademark of Texas Instruments.

MHL, Mobile High-Definition Link and the MHL Logo are trademarks or registered trademarks of MHL Licensing, LLC.

All other product names used in this manual are the properties of their respective owners and are Acknowledged.

FCC

This device has been tested and found to comply with the limits for a Class B digital device pursuant to Part 15 of the FCC rules. These limits are designed to provide reasonable protection against harmful interference in a residential installation. This device generates, uses and can radiate radio frequency energy and, if not installed and used in accordance with the instructions, may cause harmful interference to radio communications.

However, there is no guarantee that interference will not occur in a particular installation. If this device does cause harmful interference to radio or television reception, which can be determined by turning the device off and on is encouraged to try to correct the interference by one or more of the following measures:

- Reorient or relocate the receiving antenna.
- Increase the separation between the device and receiver.
- Connect the device into an outlet on a circuit different from that to which the receiver is connected.
- Consult the dealer or an experienced radio/television technician for help.

Notice: Shielded cables

All connections to other computing devices must be made using shielded cables to maintain compliance with FCC regulations.

Caution

Changes or modifications not expressly approved by the manufacturer could void the user's authority, which is granted by the Federal Communications Commission, to operate this projector.

Operation Conditions

This device complies with Part 15 of the FCC Rules. Operation is subject to the following two conditions:

1. This device may not cause harmful interference and
2. This device must accept any interference received, including interference that may cause undesired operation.

Notice: Canadian users

This Class B digital apparatus complies with Canadian ICES-003.

Remarque à l'intention des utilisateurs canadiens

Cet appareil numérique de la classe B est conforme à la norme NMB-003 du Canada.

Declaration of Conformity for EU countries

- EMC Directive 2014/30/EC (including amendments)
- Low Voltage Directive 2014/35/EC
- RED 2014/53/EU (if product has RF function)

WEEE



Disposal instructions

Do not throw this electronic device into the trash when discarding. To minimize pollution and ensure utmost protection of the global environment, please recycle it.

INTRODUCTION

Thank you for purchasing an Optoma 4K UHD projector. For full list of features please visit the product page on our website, where you will also find additional information and documentation such as voice control setup and FAQs.

Package Overview

Carefully unpack and verify that you have the items listed below under standard accessories. Some of the items under optional accessories may not be available depending on the model, specification and your region of purchase. Please check with your place of purchase. Some accessories may vary from region to region.

The warranty card is only supplied in some specific regions. Please consult your dealer for detailed information.

Standard accessories

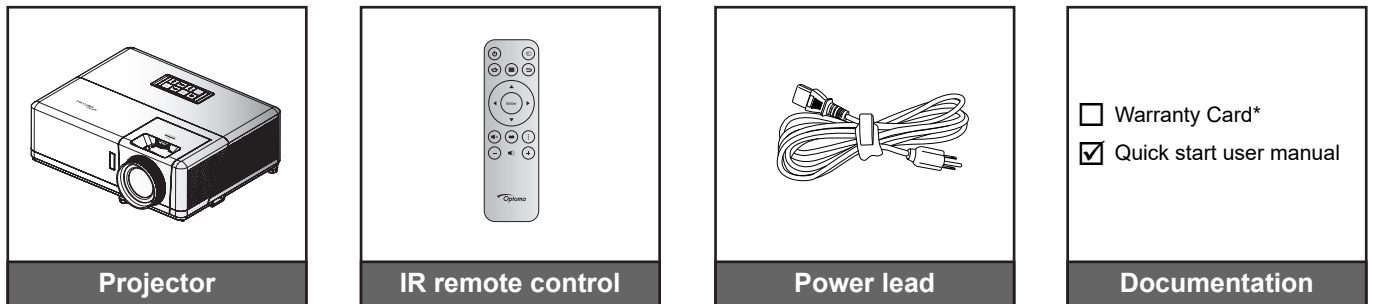

Note:

- *The actual remote control may vary depending on the region.*
- *The remote control is shipped with battery.*
- ** For warranty Information, please visit <https://www.optoma.com/support/download>.*

Optional accessories

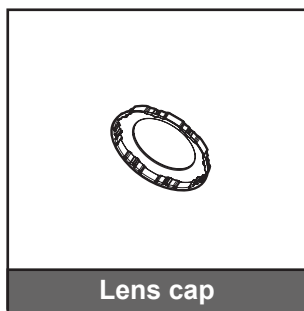

Note: *Accessories vary depending on model, specification and region. Some optional accessories may be available to purchase in select regions. Please visit our website to see more details regarding the accessories included.*

INTRODUCTION

Product Overview

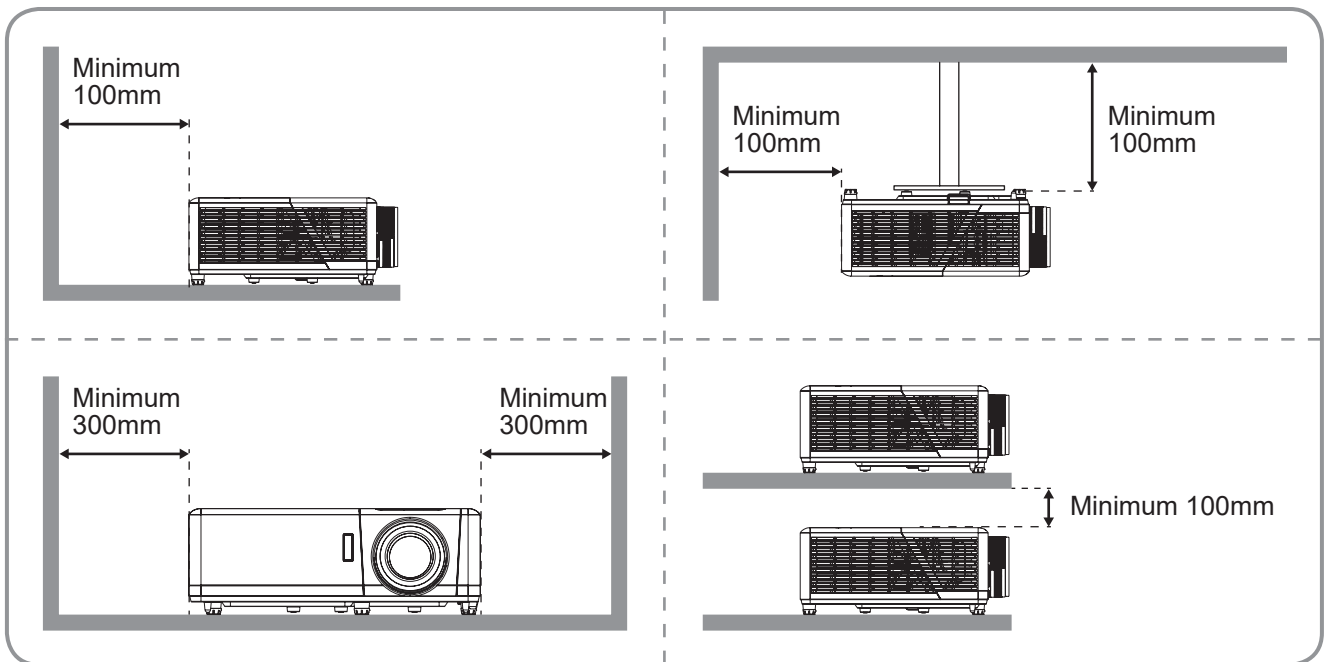
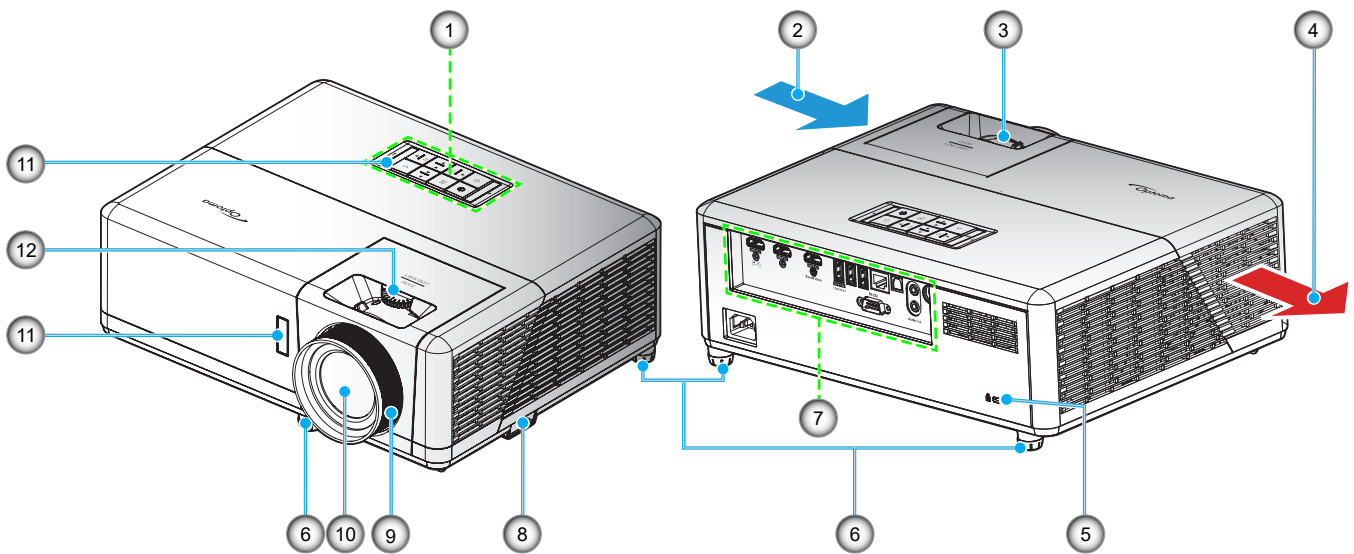

Note:

- Do not block projector intake and exhaust vents.
- When operating the projector in an enclosed space, allow at least 30 cm clearance around the intake and exhaust vents.

No	Item	No	Item
1.	Keypad	7.	Input / Output
2.	Ventilation (inlet)	8.	Security Bar
3.	Zoom Lever	9.	Focus Ring
4.	Ventilation (outlet)	10.	Lens
5.	Kensington™ Lock Port	11.	IR Receiver (front and top)
6.	Tilt-Adjustment Feet	12.	Lens Shift Dial

INTRODUCTION

Connections

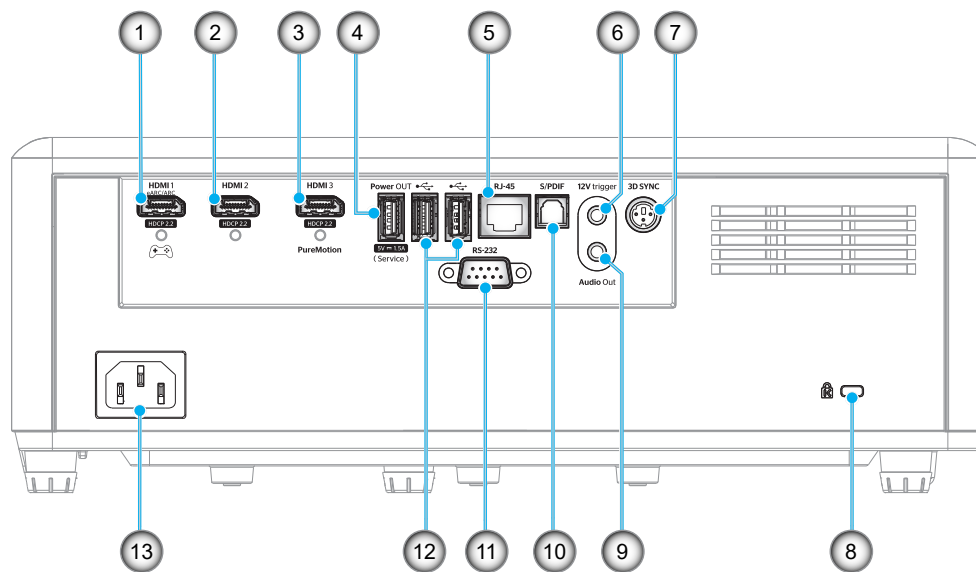

No	Item	No	Item
1.	HDMI 1 Connector (eARC/ARC out; low latency mode)	8.	Kensington™ Lock Port
2.	HDMI 2 Connector (eARC audio format through the HDMI-1 connector)	9.	Audio Out Connector
3.	HDMI 3 Connector (pass ARC audio format through the HDMI-1 connector; PureMotion support)	10.	S/PDIF Connector (only 2ch PCM supported; Dolby Digital (5.1))
4.	USB Power OUT (5V---1.5A) Connector (for service)	11.	RS-232 Connector
5.	RJ-45 Connector	12.	USB Port (WiFi dongle/Media Player)
6.	12V Trigger (DC output; Volts: 12V, Amps: 0.5A Max)	13.	Power Socket
7.	3D SYNC		

INTRODUCTION

Keypad

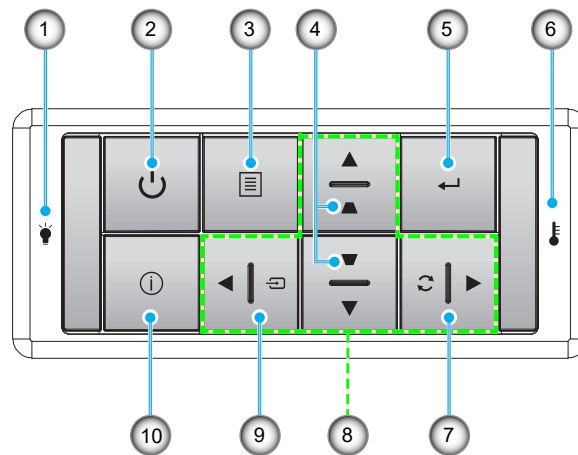

No	Item	No	Item
1.	Light Source LED	6.	Temp LED
2.	Power and Power LED	7.	Re-Sync
3.	Menu	8.	Four Directional Select Keys
4.	Keystone Correction	9.	Source
5.	Enter	10.	Information

Note: The keypad does not control the home screen. Please use the remote control to navigate.

INTRODUCTION

Remote control

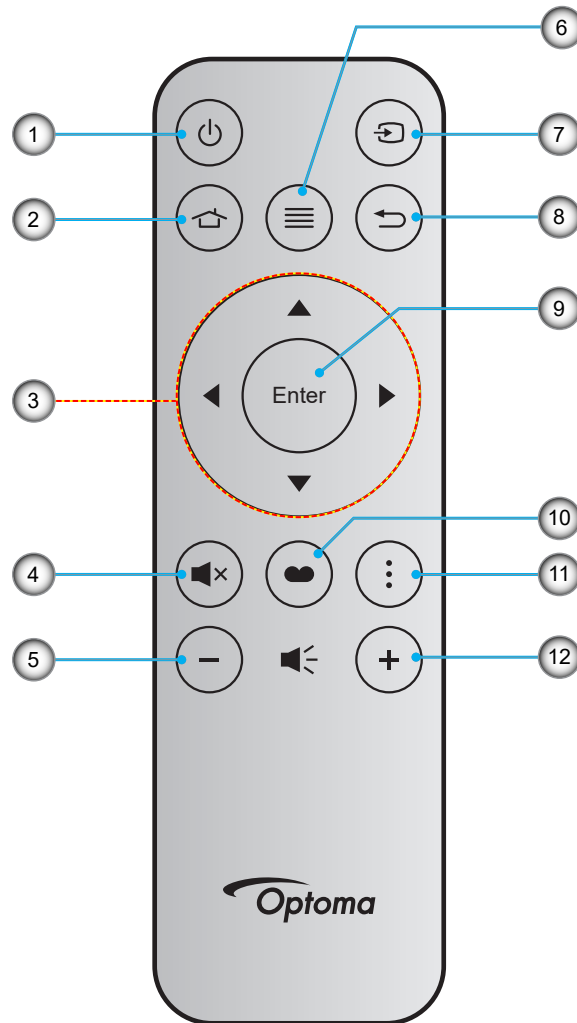

No	Item	No	Item
1.	Power On / Off	7.	Source
2.	Home	8.	Return
3.	Four Directional Select Keys	9.	Enter
4.	Mute	10.	Display Mode
5.	Volume -	11.	APP menu
6.	Menu	12.	Volume +

Note:

- Some keys may have no function for models that do not support these features.
- Before using the remote control for the first time, remove the transparent insulation tape. See page 18 for battery installation.

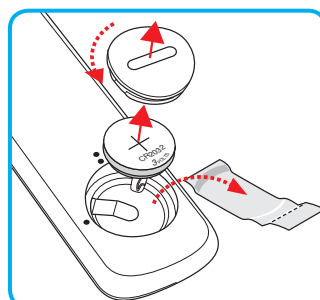

SETUP AND INSTALLATION

Installing the projector

Your projector is designed to be installed in one of four possible positions.

Your room layout or personal preference will dictate which installation location you select. Take into consideration the size and position of your screen, the location of a suitable power outlet, as well as the location and distance between the projector and the rest of your equipment.

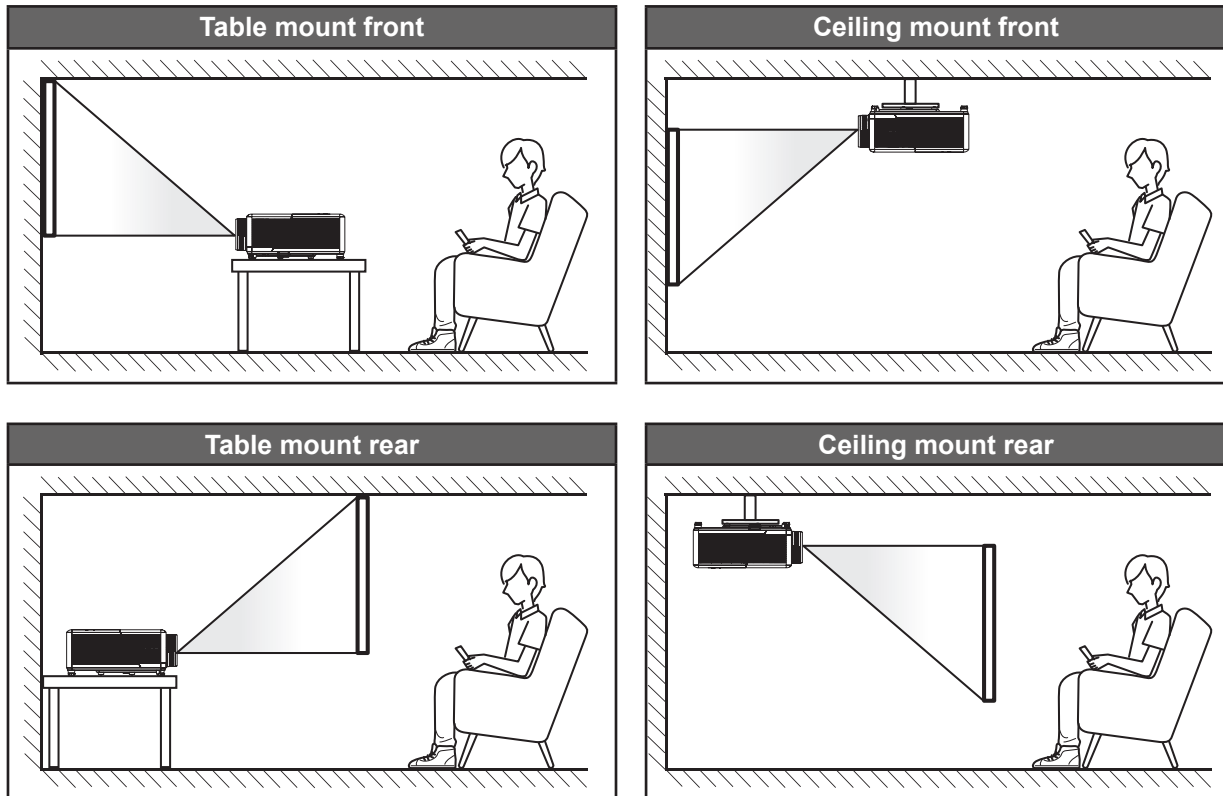

Projector should be placed flat on a surface and 90 degrees / perpendicular to the screen.

- How to determine projector location for a given screen size, please refer to distance table on page 65.
- How to determine screen size for a given distance, please refer to distance table on page 65.

Note: *The further away the projector is placed from the screen the projected image size increases and vertical offset also increases proportionally.*

IMPORTANT!

Do not operate the projector in any orientation other than table top or ceiling mount. The projector should be horizontal and not tilted either forwards/backwards or left/right. Any other orientation will invalidate the warranty and may shorten the lifetime of the projector. For non standard installation advise please contact Optoma.

SETUP AND INSTALLATION

Projector installation notice

- 360° free orientation operation

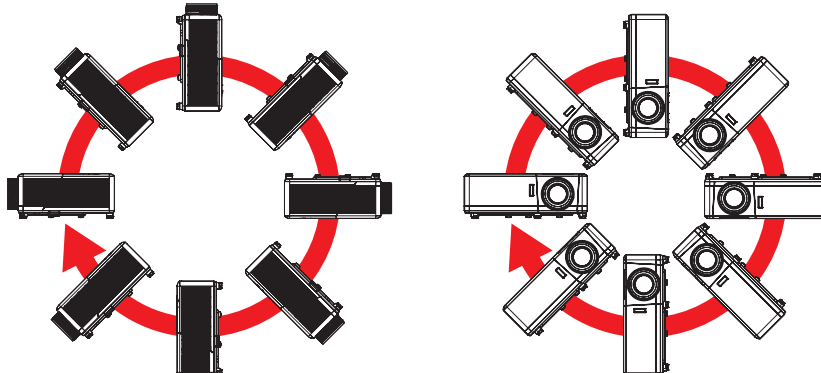

- Allow at least 30 cm clearance around the exhaust vent.

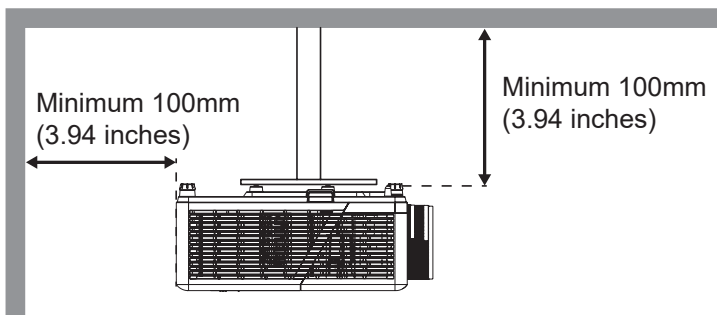
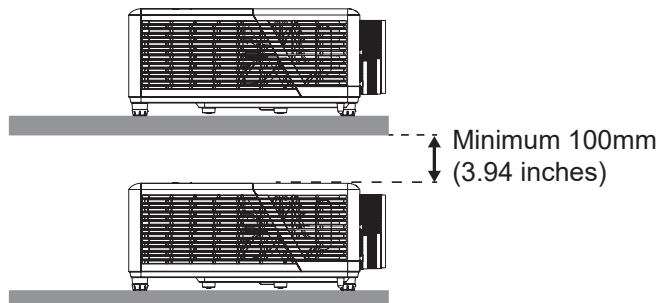
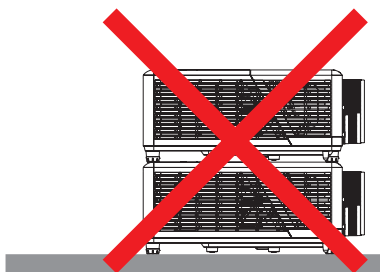
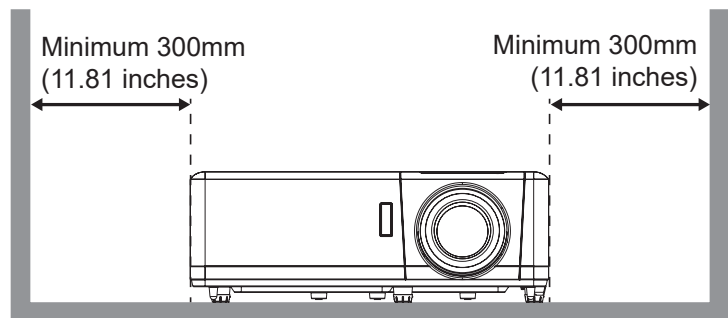
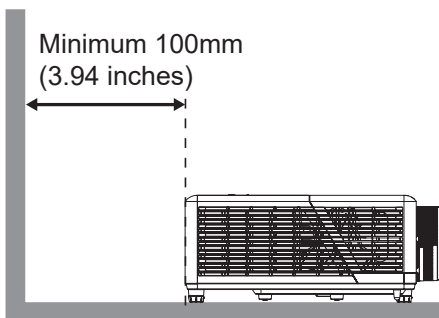

- Ensure that the intake vents do not recycle hot air from the exhaust vent.
- When operating the projector in an enclosed space, ensure that the surrounding air temperature within the enclosure does not exceed operation temperature while the projector is running, and the air intake and exhaust vents are unobstructed.
- All enclosures should pass a certified thermal evaluation to ensure that the projector does not recycle exhaust air, as this may cause the device to shutdown even if the enclosure temperature is within the acceptable operation temperature range.

SETUP AND INSTALLATION

Connecting sources to the projector

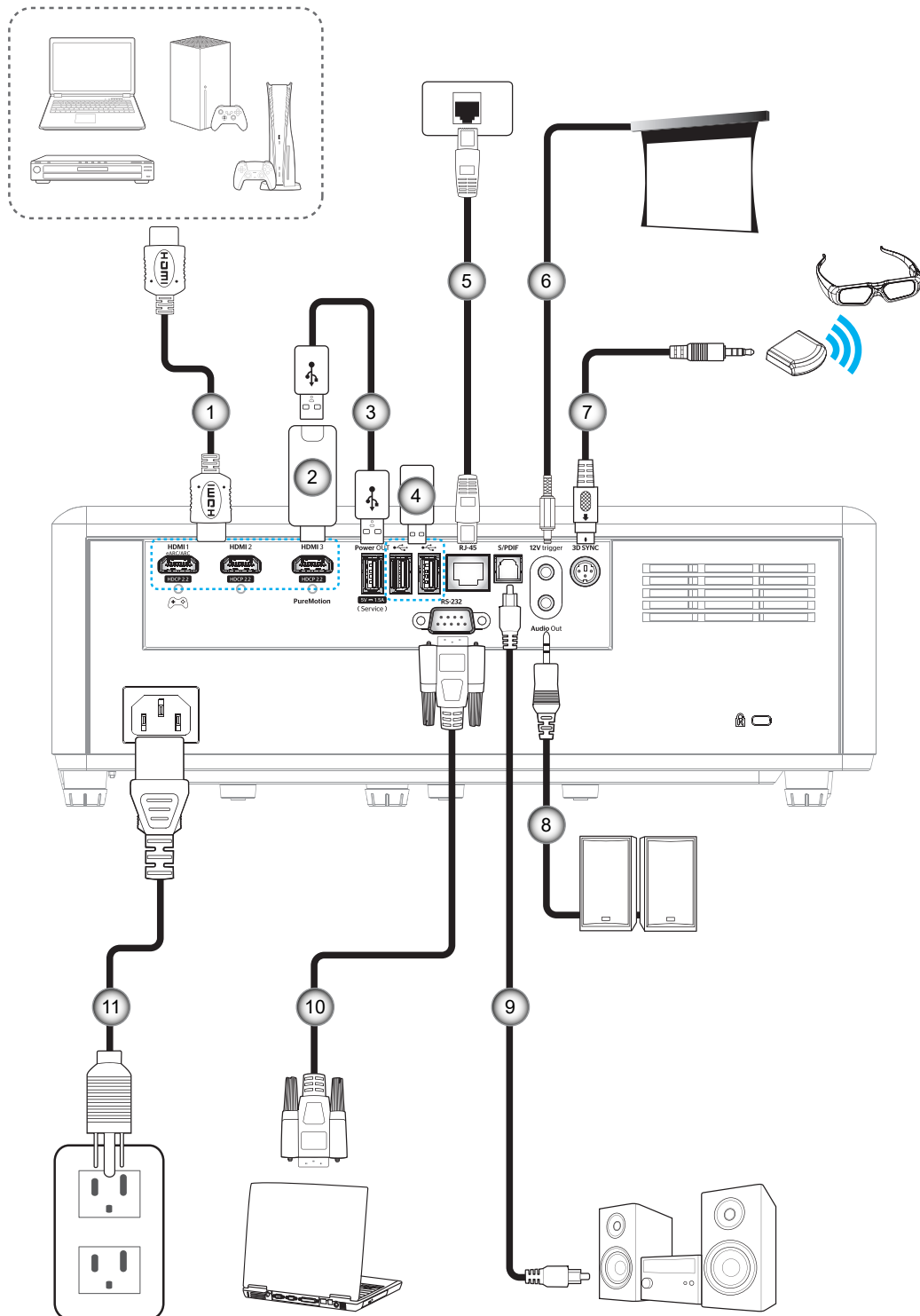

No	Item
1.	HDMI Cable
2.	HDMI Dongle
3.	USB Power Cable
4.	USB Disk Drive

No	Item
5.	RJ-45 Cable
6.	12V DC Jack
7.	3D Emitter Cable
8.	Audio Out Cable

No	Item
9.	S/PDIF Out Cable
10.	RS-232 Cable
11.	Power Cord

Note: To ensure the best image quality and avoid connection errors, we recommend the use of Premium HDMI cables. For the cable lengths longer than 20-25 feet, we strongly recommend using Active Fiber HDMI cables.

SETUP AND INSTALLATION

Adjusting the projector image

Image height

The projector is equipped with elevator feet for adjusting the image height.

1. Locate the adjustable foot you wish to adjust on the underside of the projector.
2. Rotate the adjustable foot clockwise or counterclockwise to raise or lower the projector.

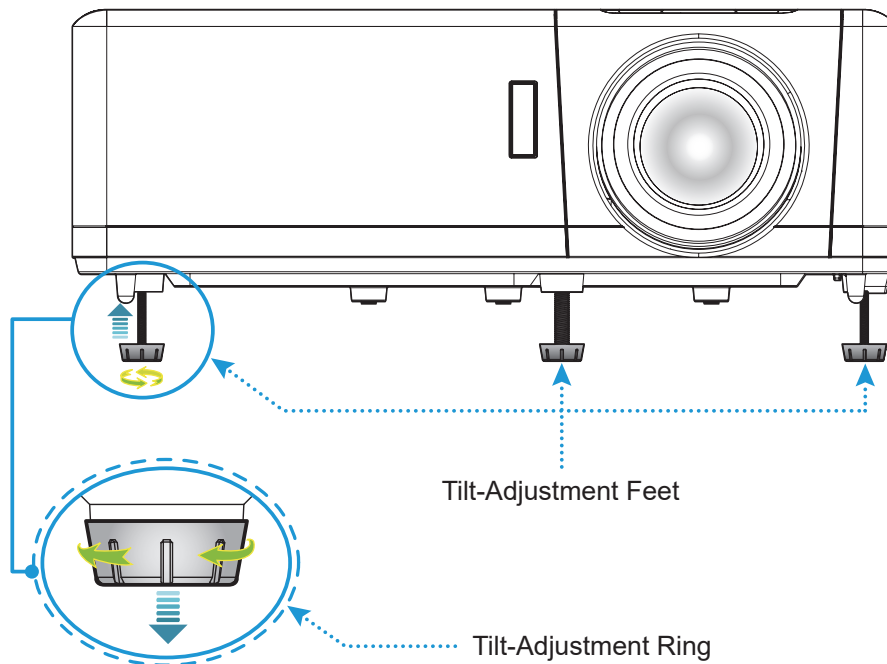

Zoom, lens shift, and focus

- To adjust the image size and position, do the following:
 - a. To adjust the image size, turn the zoom lever clockwise or counterclockwise to increase or decrease the projected image size.
 - b. To adjust the image position, turn the lens shift dial clockwise or counterclockwise to adjust the position of the projected image vertically.
- To adjust the focus, turn the focus ring clockwise or counterclockwise until the image is sharp and legible.

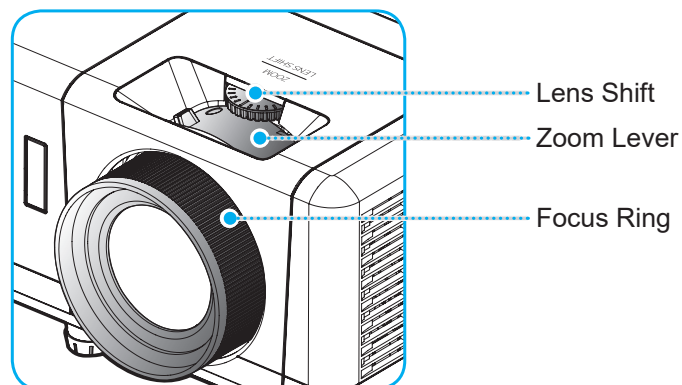

Note: The projector will focus at a distance of 1.2m to 8.1m.

SETUP AND INSTALLATION

Remote setup

Installing / replacing the battery

1. Use a coin to turn the battery cover counterclockwise until the cover opens.
2. Install new battery into the compartment.
Remove the old battery and install new one (CR2032). Ensure that the side with a "+" is facing up.
3. Put the cover back. Then use a coin to turn the battery cover clockwise to lock it in place.

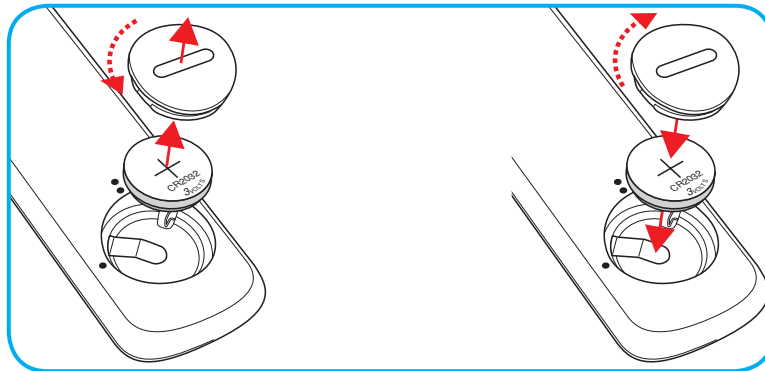

CAUTION:

To ensure safe operation, please observe the following precautions:

- Use CR2032 type battery.
- Avoid contact with water or liquid.
- Do not expose the remote control to moisture or heat.
- Do not drop the remote control.
- If the battery has leaked in the remote control, carefully wipe the case clean and install new battery.
- Risk of an explosion if battery is replaced by an incorrect type.
- Dispose of used battery according to the instructions.

Warning: Do not ingest battery, Chemical Burn Hazard.



- This product contains a coin / button cell battery. If the coin / button cell battery is swallowed, it can cause severe internal burns in just 2 hours and can lead to death.

Warning: Keep new and used batteries away from children.



- If the battery compartment does not close securely, stop using the product and keep it away from children. If you think batteries might have been swallowed or placed inside any part of the body, seek immediate medical attention.

SETUP AND INSTALLATION

Effective range

Infra-Red (IR) remote control sensor is located on top of the projector. Ensure to hold the remote control at an angle within 30° (horizontally) or 20° (vertically) perpendicular to the projector's IR remote control sensor to function correctly. The distance between the remote control and the sensor should not be longer than 7 meters (~22 feet).

Note: When pointing the remote control directly (0 degrees angle) on the IR sensor, the distance between the remote control and the sensor should not be longer than 10 meters (~32 feet).

- Make sure that there are no obstacles between the remote control and the IR sensor on the projector that might obstruct the infra-red beam.
- Make sure the IR transmitter of the remote control is not being shined by sunlight or fluorescent lamps directly.
- Please keep the remote controller away from fluorescent lamps for over 2 meters or the remote controller might become malfunction.
- If the remote control is close to Inverter-Type fluorescent lamps, it might become ineffective from time to time.
- If the remote control and the projector are within a very short distance, the remote control might become ineffective.
- When you aim at the screen, the effective distance is less than 7 meters from the remote control to the screen and reflecting the IR beams back to the projector. However, the effective range might change according to screens.

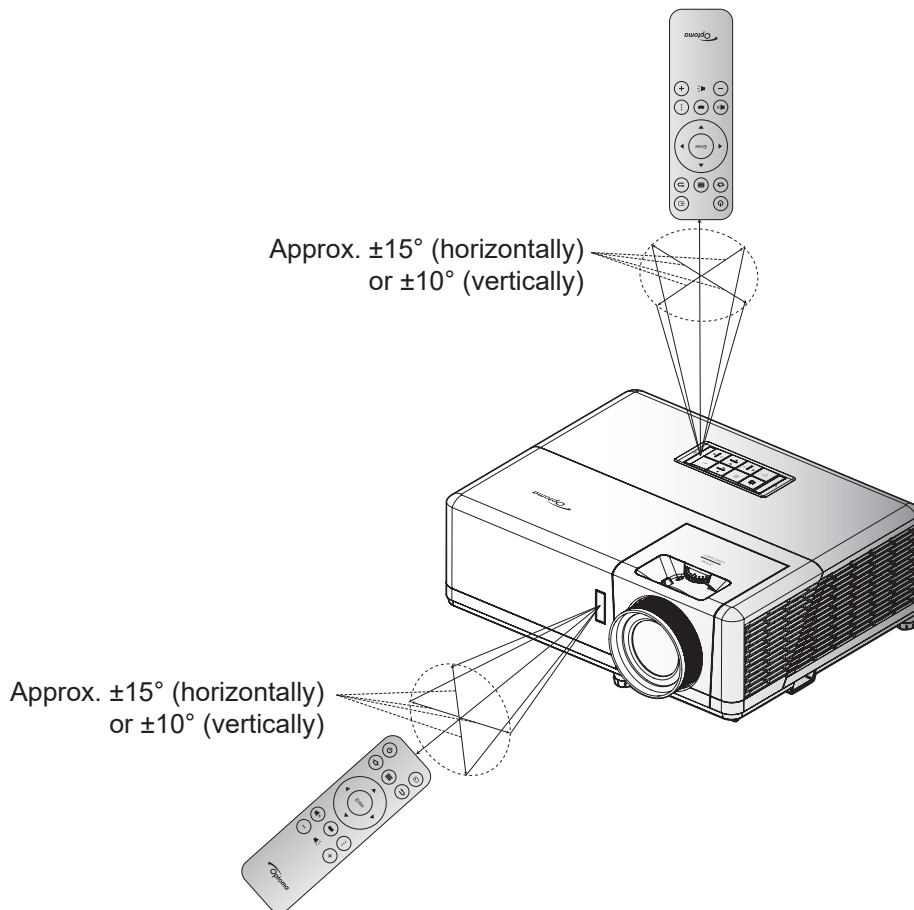

USING THE PROJECTOR

Powering on / off the projector

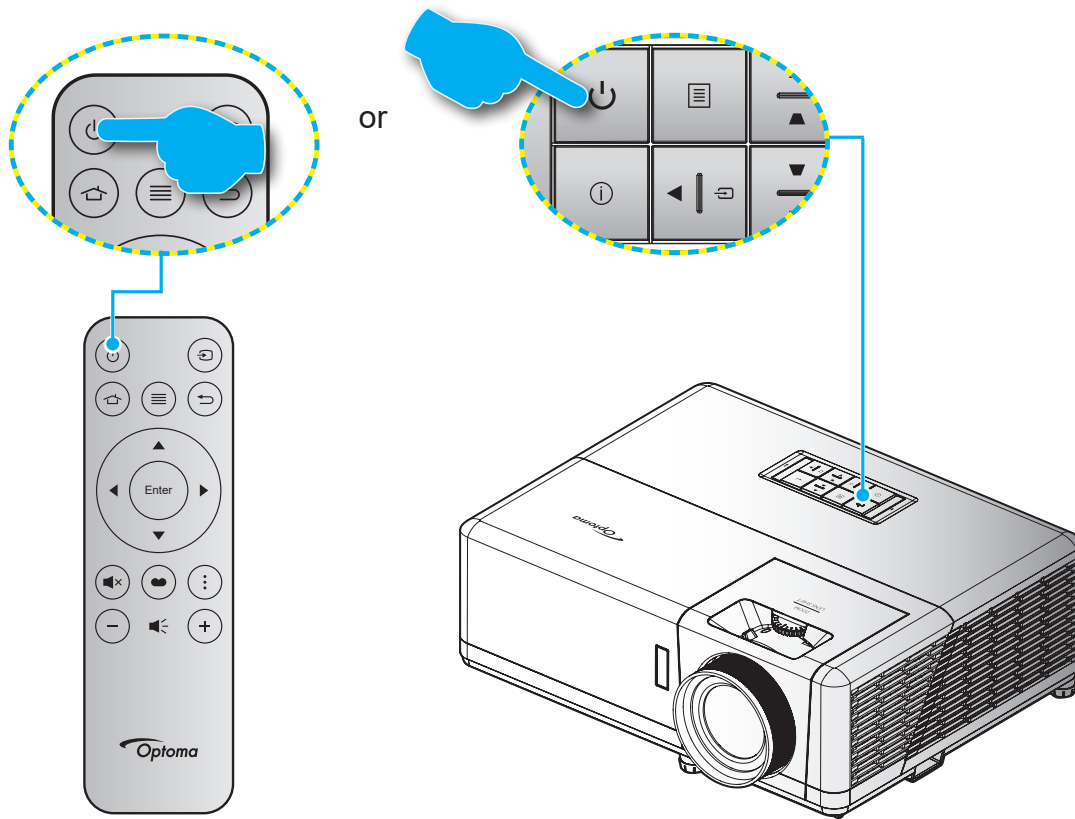

Powering on

1. Securely connect the power lead and signal/source cable. When connected, the On/Standby LED will turn red.
2. Turn on the projector by pressing the “⏻” button on the projector keypad or the remote control.
3. A start up screen will display in approximately 10 seconds and the On/Standby LED will be flashing blue.

Note: *The first time the projector is turned on, you will be prompted to select the preferred language, projection orientation, and other settings.*

USING THE PROJECTOR

The first time the projector is turned on, you will be prompted to do the initial setup including selecting the projection orientation, preferred language, configuring network settings, and more. Once the **Setup Complete!** screen appears, it indicates the projector is ready to use.

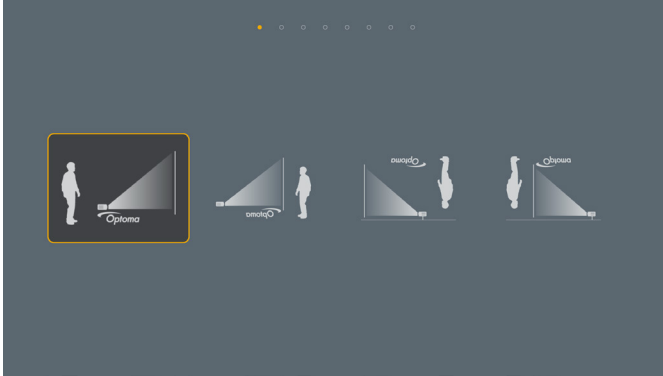

[Projection screen]



[Language screen]

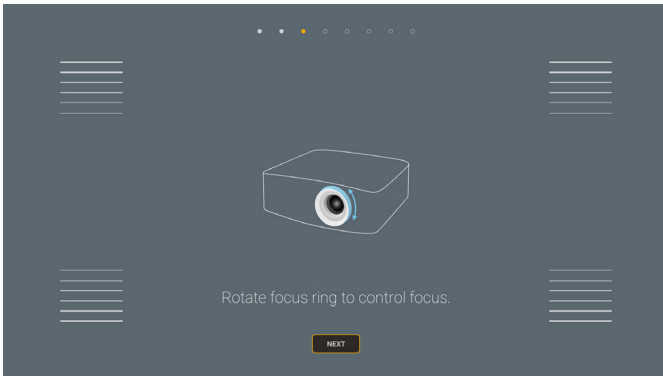

[Focus adjustment screen]

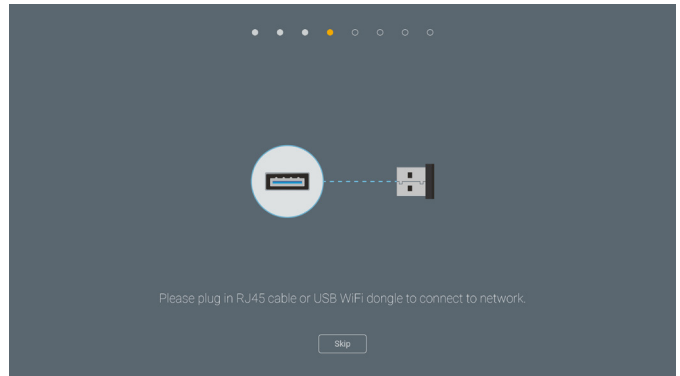

[Wi-Fi dongle installation screen]

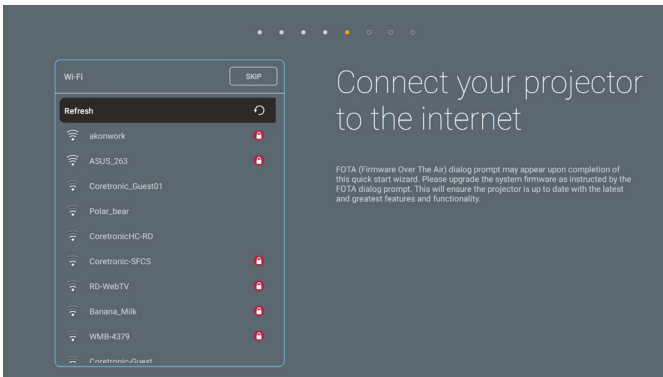

[Network screen]

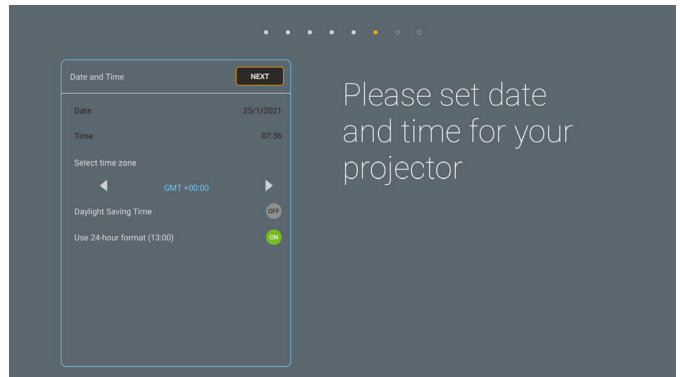

[Date and time screen]

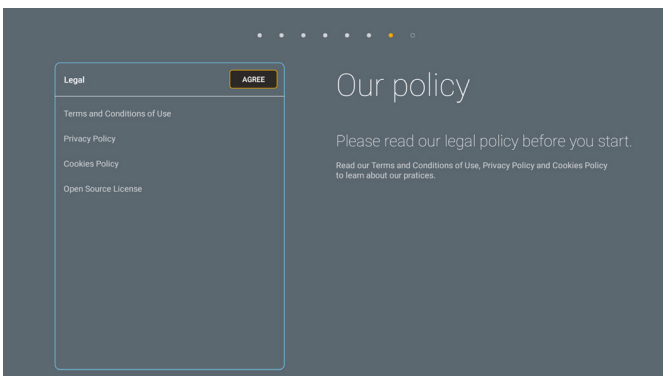

[Regulation screen]

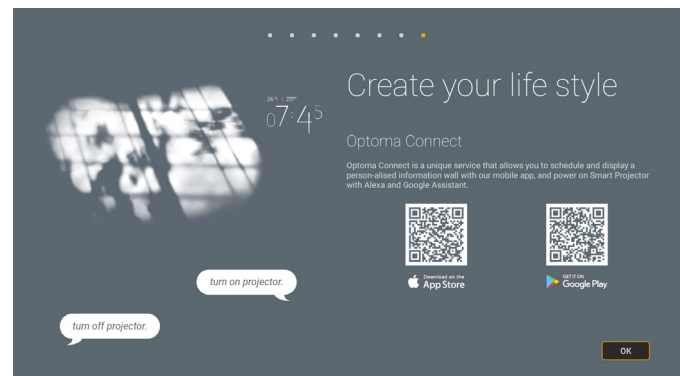

[Optoma Connect screen]

USING THE PROJECTOR

Powering off

1. Turn off the projector by pressing the “⏻” button on the projector keypad or the remote control.
2. The following message will be displayed:

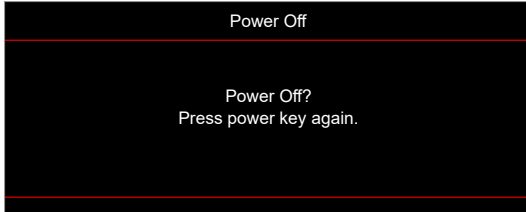

3. Press the “⏻” button again to confirm, otherwise the message will disappear after 15 seconds. When you press the “⏻” button for the second time, the projector will shut down.
4. The cooling fans will continue to operate for about 10 seconds for the cooling cycle and the On/Standby LED will flash blue. When the On/Standby LED turns solid red, this indicates the projector has entered standby mode. If you wish to turn the projector back on, you must wait until the cooling cycle has finished and the projector has entered standby mode. When the projector is in standby mode, simply press the “⏻” button again to turn on the projector.
5. Disconnect the power lead from the electrical outlet and the projector.

Note: *It is not recommended that the projector is turned on immediately, right after a power off procedure.*

USING THE PROJECTOR

Selecting an input source

Turn on the connected source that you want to display on the screen, such as computer, notebook, video player, etc. The projector will automatically detect the source. If multiple sources are connected, press the “” button on the projector keypad or the remote control to select the desired input.

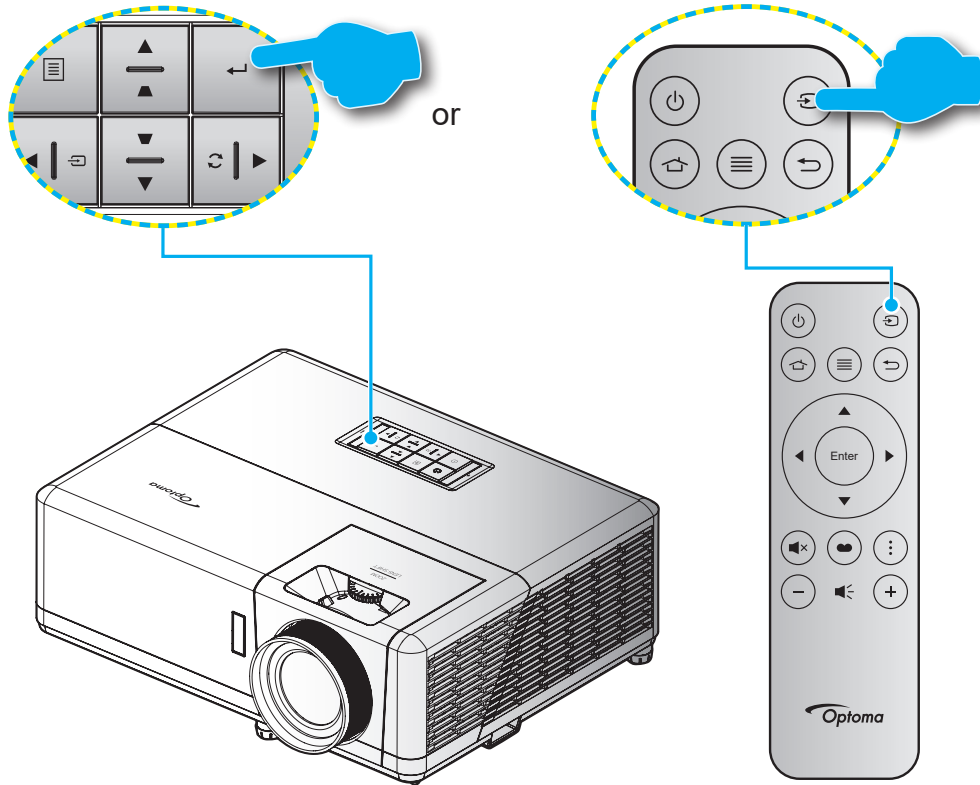

USING THE PROJECTOR

Home screen overview

The Home screen is displayed every time you start the projector. It contains system date and time, system status, icons to access OSD menu, projector settings menu, apps, input sources, and more.

To navigate the Home screen, simply use the buttons on the remote control.

You can return to the Home screen at any time by pressing “” on the remote control, regardless of your position in the user interface.

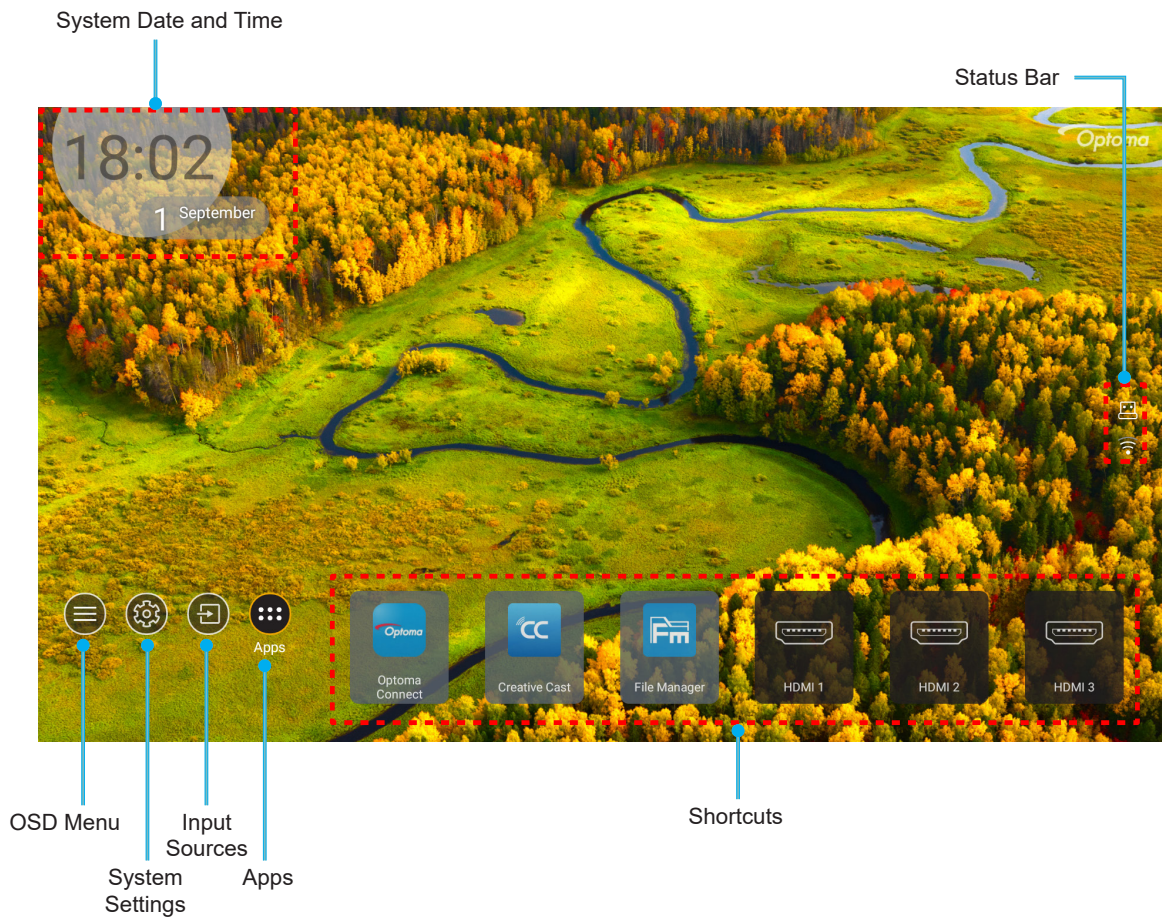

Note: The selected menu or item is highlighted in orange color, for example “Apps” on the image above.

System date and time

Date and time is displayed on the Home screen if the projector is connected to the network. The default setting is 10:00am, 2019/01/01. AM/PM will appear only if the 24-hour format is off.

To modify date and time parameters, select the respective field on the screen. The Date and Time settings page opens automatically. Then perform the modifications.

USING THE PROJECTOR

Projector settings menu (OSD)

Press “≡” on the remote control or on the Home screen, select the OSD menu “⊞” to review projector information or manage various settings related to the image, display, 3D, audio, and setup.

General menu navigation

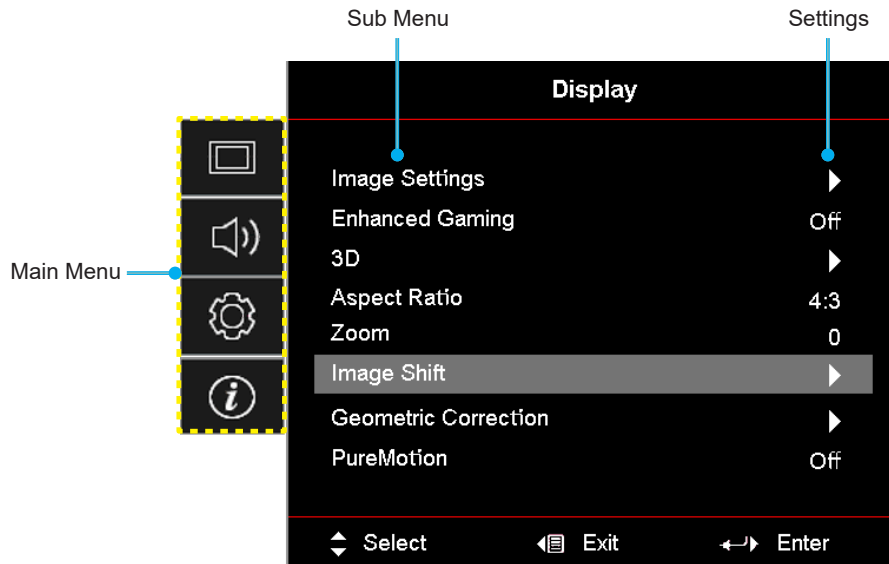

1. When OSD is displayed, use the up and down navigation buttons to select any item in the main menu. While making a selection on a particular page, press “OK” to enter submenu.
2. Press the “Left” and “Right” button to select the desired menu item. Then press “OK” to open its sub menu.
3. Press the “Up” and “Down” button to select the desired item in the sub menu.
4. Press the “OK” button to enable or disable a setting or press the “Left” and “Right” button to adjust a value.
5. Select the next item to be adjusted in the sub menu and modify as described above.
6. To exit, press “↶” (repeatedly if necessary). The OSD menu will close and the projector will automatically save the new settings.

USING THE PROJECTOR

OSD Menu tree



Note: The OSD menu tree items and features are subject to models and region. Optoma reserve the right to add or remove items to improve product performance without notice.

Main Menu	Sub Menu 1	Sub Menu 2	Sub Menu 3	Sub Menu 4	Values		
Display	Image Settings	Display Mode	[Video] Mode		Cinema		
					HDR		
					HLG		
					HDR SIM.		
					Game		
					Reference		
					Bright		
					User		
					3D		
					ISF Day		
					ISF Night		
					ISF 3D		
		Wall Color					Off (Default)
							Blackboard
							Light Yellow
							Light Green
							Light Blue
							Pink
		Dynamic Range			HDR / HLG		Gray
							Off
					HDR Picture Mode		Auto [Default]
							Bright
							Standard [Default]
							Film
					HLG Picture Mode		Detail
							Bright
							Standard [Default]
						Film	
			Detail				
			HDR Brightness			0 ~ 10	
		Brightness				-50 ~ 50	
		Contrast				-50 ~ 50	
		Sharpness				1 ~ 15	
Color				-50 ~ 50			
Tint				-50 ~ 50			





USING THE PROJECTOR

Main Menu	Sub Menu 1	Sub Menu 2	Sub Menu 3	Sub Menu 4	Values	
Display	Image Settings	Gamma	Film			
			Video			
			Graphics			
			Standard(2.2)			
			1.8			
			2.0			
			2.4			
			3D			
		Color Settings	BrilliantColor™			1 ~ 10
				Color Temperature		Warm
						Standard
						Cool
					Cold	
			Color Matching	Color		Red
						Green
						Blue
						Cyan
						Yellow
						Magenta
						White(*)
					Hue / R(*)	-50 ~ 50 [Default: 0]
					Saturation / G(*)	-50 ~ 50 [Default: 0]
					Gain / B(*)	-50 ~ 50 [Default: 0]
				Reset	Cancel [Default]	
					Yes	
				Exit		
			RGB Gain/Bias	Red Gain		-50 ~ 50
				Green Gain		-50 ~ 50
				Blue Gain		-50 ~ 50
				Red Bias		-50 ~ 50
				Green Bias		-50 ~ 50
				Blue Bias		-50 ~ 50
				Reset		Cancel [Default]
						Yes
				Exit		
			Color Space (Not HDMI Input)			Auto [Default]
					RGB	
					YUV	
		Color Space (HDMI Input)			Auto [Default]	
					RGB(0~255)	
			RGB(16~235)			
			YUV			





USING THE PROJECTOR

Main Menu	Sub Menu 1	Sub Menu 2	Sub Menu 3	Sub Menu 4	Values	
Display	Image Settings	Brightness Mode			DynamicBlack	
					Eco.	
					Constant Power Power =100%/95%/90%/85%/80%/75%/70%/65%/60%/55%/50%	
					Constant Luminance Power=85%/80%/75%/70%	
		Reset				
	Enhanced Gaming					Off
						On
	3D	3D Mode				Off [Default]
						On
		3D Sync Invert				On
						Off [Default]
	Aspect Ratio					4:3
						16:9
						21:9
						32:9
						V-Stretch (except SVGA XGA model)
						Full screen
						Auto
	Zoom					-5 ~ 25 [Default: 0]
	Image Shift	H 				-100 ~ 100 [Default: 0]
		V 				-100 ~ 100 [Default: 0]
	Geometric Correction	Four Corner				
		H Keystone				-30 ~ 30 [Default: 0]
		V Keystone				-30 ~ 30 [Default: 0]
		Auto Keystone				Off
		3x3 Warp				On [Default]
		Reset				
PureMotion	PureMotion				Off	
					1	
					2	
					3 [Default]	
Audio	Audio Mode				Speaker / Audio Out [Default]	
					SPDIF / eARC	
	Mute				Off [Default]	
					On	
Volume					0 ~ 10 [Default: 5]	
Audio	Digital Output Format				Bitstream	
					PCM	
					Auto [Default]	
Audio Delay	Internal speaker delay				-50 ~ +50 [Default: 0]	

USING THE PROJECTOR

Main Menu	Sub Menu 1	Sub Menu 2	Sub Menu 3	Sub Menu 4	Values		
Setup	Projection				Front  [Default]		
					Rear 		
					Ceiling-top 		
					Rear-top 		
	Power Settings	Direct Power On				Off [Default]	
						On	
		Signal Power On				Off [Default]	
						On	
		Auto Power Off (min.)				0 ~ 180 (5 min increments) [Default: 20]	
		Sleep Timer (min.)				0 ~ 990 (30 min increments) [Default: 0]	
			Always On				No [Default]
	Power Mode (Standby)					Yes	
						Active (SmartHome)	
						Eco [Default]	
	USB Power (Standby)					Off [Default]	
						On	
	Security	Security				Off	
						On	
		Security Timer	Month				
			Day				
			Hour				
	Change Password					[Default: 1234]	
	HDMI Link Settings	HDMI Link				Off [Default]	
						On	
		Inclusive of TV					No [Default]
							Yes
		Power On Link					Mutual [Default]
							PJ --> Device
		Power Off Link					Device --> PJ
						Off [Default]	
	Test Pattern					On	
						Green Grid	
						Magenta Grid	
					White Grid		
					White		
Remote Settings	IR Function				Off		
						On [Default]	
Projector ID					00 ~ 99		

USING THE PROJECTOR

Main Menu	Sub Menu 1	Sub Menu 2	Sub Menu 3	Sub Menu 4	Values		
Setup	12V Trigger				On		
					Off [Default]		
	Options	Language				English [Default]	
						Deutsch	
						Français	
						Italiano	
						Español	
						Português	
						簡體中文	
						繁體中文	
						日本語	
						한국어	
						Русский	
		Menu Settings	Menu Location				Top Left 
							Top Right 
							Center  [Default]
							Bottom Left 
							Bottom Right 
			Menu Timer				
							5sec
							10sec [Default]
		Auto Source					Off [Default]
							On
		Input Source					HDMI1
							HDMI2
							HDMI3
							Home
		Input Name			HDMI1		Default [Default] / Custom
					HDMI2		Default [Default] / Custom
				HDMI3		Default [Default] / Custom	
				Home		Default [Default] / Custom	
	High Altitude					Off [Default]	
						On	
	Display Mode Lock					Off [Default]	
						On	
	Keypad Lock					Off [Default]	
						On	
	Information Hide					Off [Default]	
						On	
	Logo					Default [Default]	
						Neutral	

USING THE PROJECTOR

Main Menu	Sub Menu 1	Sub Menu 2	Sub Menu 3	Sub Menu 4	Values	
Setup	Options	Background Color			None [Default for Video/Pro-AV]	
					Blue [Default for Data model]	
					Red	
					Green	
					Gray	
	Reset	Reset OSD			Cancel [Default]	
					Yes	
		Reset to Default			Cancel [Default]	
					Yes	
		Android Reset			Cancel [Default]	
			Yes			
Info	Regulatory					
	Serial Number					
	Source					
	Resolution				00x00	
	Refresh Rate				0.00Hz	
	Display Mode					
	Projector ID				00~99	
	Brightness Mode					
	FW Version	System				
		Android				
		MCU				
	MAC Address					

USING THE PROJECTOR

Display menu

Image settings menu

Display Mode

There are several predefined display modes that you can choose from to suit your viewing preference. Each mode has been fine-tuned by our expert colour team to ensure superior colour performance for wide range of content.

- **Cinema:** Provides the best balance of detail and colors for watching movies.
- **HDR:** Delivers color that is highly accurate, exceeding the color performance of the other display modes. This mode decodes and displays High Dynamic Range (HDR) content for the deepest blacks, brightest whites, and vivid cinematic color using REC.2020 color gamut.
Note: *This mode will be automatically enabled if HDR is set to Auto (and HDR content is sent to projector – 4K UHD Blu-ray, 1080p/4K UHD HDR games, 4K UHD streaming video). While HDR mode is active, all other display modes will be greyed out.*
- **HLG:** Delivers color that is highly accurate, exceeding the color performance of the other display modes. This mode decodes and displays Hybrid Log content (HLG) content for the deepest blacks, brightest whites, and vivid cinematic color using REC.2020 color gamut.
Note:
 - *This mode will be automatically enabled if HDR is set to Auto (and HLG content is sent to projector). While HLG mode is active, all other display modes will be greyed out.*
 - *Only HDMI1 and HDMI2 support HLG.*
- **HDR SIM.:** Enhances non-HDR content with simulated High Dynamic Range (HDR). Choose this mode to enhance gamma, contrast, and color saturation for non-HDR content (720p and 1080p Broadcast/Cable TV, 1080p Blu-ray, non-HDR Games, etc).
Note: *This mode can ONLY be used with non-HDR content.*
- **Game:** Optimises your projector for maximum contrast and vivid colours allowing you to see shadow detail when playing video game.
Note: *This display mode cannot be used when viewing HDR video content or playing HDR games. To enable low input lag, please ensure the PC or console is connected to HDMI1 and enable Enhanced Game Mode.*
- **Reference:** This mode reproduces colours as close as possible the image the way the movie director intended. Color, color temperature, brightness, contrast and gamma settings are all configured to Rec.709 color gamut. Select this mode for the most accurate colour reproduction when watching movies.
- **Bright:** This mode is suitable for environments where extra-high brightness is required, such as using the projector in well-lit rooms.
- **User:** Memorizes user defined setting, tailor your own display mode settings.
- **3D:** Optimized settings for watching 3D content.
Note: *To experience the 3D effect, you will need to have compatible DLP Link 3D glasses. See 3D section for more information.*
- **ISF Day:** Save professionally calibrated picture settings optimized for day time viewing.
- **ISF Night:** Save professionally calibrated picture settings optimized for night time viewing.
- **ISF 3D:** Save professionally calibrated picture settings optimized for 3D viewing.

Note:

- ISF modes need to be professionally calibrated. To unlock and access ISF modes, you will need to enter the following code using the remote or keypad: Power > Up > Down > Up > Up.
- ISF modes are available only in Video mode.
- If HDR or HLG are enabled, Cinema, Game, Reference, and Bright options are grayed out.

USING THE PROJECTOR

Wall Color

Designed to adjust the colors of the projected image when projecting on to a wall without a screen. Each mode has been fine-tuned by our expert colour team to ensure superior color performance. There are several predefined modes that you can choose from to suit the colour of your wall. Select between off, blackboard, light yellow, light green, light blue, pink, and gray.

Note: For accurate color reproduction, we recommend using a screen.

Dynamic Range

Configure the High Dynamic Range (HDR) setting and its effect when displaying video from 4K Blu-ray players and streaming devices.

➤ HDR/HLG

- **Off:** Turn off HDR or HLG processing. When set to Off, the projector will NOT decode HDR or HLG content.
- **Auto:** Auto detect HDR signal.

➤ HDR Picture Mode

- **Bright:** Choose this mode for brighter more saturated colors.
- **Standard:** Choose this mode for natural looking colors with a balance of warm and cool tones.
- **Film:** Choose this mode for improved detail and image sharpness.
- **Detail:** The signal comes from OETF conversion to achieve the best color matching and highest level of detail.

➤ HLG Picture Mode

- **Bright:** Choose this mode for brighter more saturated colors.
- **Standard:** Choose this mode for natural looking colors with a balance of warm and cool tones.
- **Film:** Choose this mode for improved detail and image sharpness.
- **Detail:** The signal comes from OETF conversion to achieve the best color matching and highest level of detail.

➤ HDR Brightness

- Adjust the brightness level of HDR.

Brightness

Adjust the brightness of the image.

Contrast

The contrast controls the degree of difference between the lightest and darkest parts of the picture.

Sharpness

Adjust the sharpness of the image.

Color

Adjust a video image from black and white to fully saturated color.

Tint

Adjust the color balance of red and green.

Gamma

Set up gamma curve type. After the initial setup and fine tuning is completed, utilize the Gamma Adjustment steps to optimize your image output.

- **Film:** For home theater.
- **Video:** For video or TV source.

USING THE PROJECTOR

- **Graphics:** For PC / Photo source.
- **Standard(2.2):** For standardized setting.
- **1.8 / 2.0 / 2.4 / 2.6:** For specific PC / Photo source. 2.4 and 2.6 can also be used for video content and games to enable deeper contrast.
- **3D:** To experience the 3D effect, you need to have 3D glasses. Make sure your PC/portable device has a 120 Hz signal output quad buffered graphics card and a 3D Player installed.

Note: *These options are only available if the 3D mode function is disabled. In 3D mode, user can only select "3D" for Gamma setting.*

Color Settings

Configure the color settings.

- **BrilliantColor™:** This adjustable item utilizes a new color-processing algorithm and enhancements to enable higher brightness while providing true, more vibrant colors in picture.
- **Color Temperature:** Select a color temperature from Warm, Standard, Cool, and Cold.
- **Color Matching:** Select the following options:
 - Color: Adjust the red (R), green (G), blue (B), cyan (C), yellow (Y), magenta (M), and white (W) level of the image.
 - Hue: Adjust the color balance of red and green.
 - Saturation: Adjust a video image from black and white to fully saturated color.
 - Gain: Adjust the image brightness.
 - Reset: Return the factory default settings for color matching.
 - Exit: Exit the "Color Matching" menu.
- **RGB Gain/Bias:** This settings allows to configure the brightness (gain) and contrast (bias) of an image.
 - Reset: Return the factory default settings for RGB gain/bias.
 - Exit: Exit the "RGB Gain/Bias" menu.
- **Color Space (HDMI Input 1 only):** Select an appropriate color matrix type from the following: Auto, RGB(0-255), RGB(16-235), and YUV.
- **Color Space (HDMI2/Home/Component only):** Select an appropriate color matrix type from the following: Auto, RGB(0-255), and RGB(16-235).

Note: *Color Space function is not supported if the source is HDMI3.*

Brightness Mode

Manually choose the power percentage for brightness mode and adjust the brightness mode settings.

- **DynamicBlack:** Use to automatically adjust the picture brightness in order to give optimum contrast performance.
- **Eco.:** Choose "Eco." to dim the projector laser diode which will lower power consumption and extend the laser diode life.
- **Constant Power:** Choose the power percentage for brightness mode.
- **Constant Luminance:** Constant Luminance varies the strength of LD luminance such that the brightness maintains consistent with time.

Reset

Return the factory default settings for color settings.

USING THE PROJECTOR

Enhanced Gaming menu

Enable this feature to reduce response times (input latency) during gaming to 4.5ms* for HDMI Port 1. All geometry settings (example: Keystone, Warping) will be disabled when Enhanced Gaming Mode is enabled. For more information is below.

Note:

- Only support to HDMI1.
- *4.5ms is only support for 1080p 240Hz signals via Gaming PC.
- The input lag by signals is described in the following table:
- The values in the table can vary slightly.

Source Timing	Enhanced Gaming	Output	Output Resolution	Input Lag
1080p60	On	1080p60	1080p	17ms
1080p120	On	1080p120	1080p	8.6ms
1080p240	On	1080p240	1080p	4.4ms
4K60	On	4K60	4K	16.9ms
1080p60	Off	1080p60	1080p	33.8ms
1080p120	Off	1080p120	1080p	17ms
1080p240	Off	1080p240	1080p	8.6ms
4K60	Off	4K60	4K	33.7ms

- Please note that if “Enhanced Gaming” mode is enabled, the 3D, Aspect Ratio, Zoom, Image Shift, and Geometric Correction functions are disabled automatically. These functions and settings will be restored when “Enhanced Gaming Mode” is disabled.

3D menu

3D Mode

Use this option to enable/disable the 3D mode function.

3D Sync Invert

Use this option to enable/disable the 3D sync invert function.

Aspect Ratio menu

Select the aspect ratio of the displayed image between the following options:

- **4:3:** This format is for 4:3 input sources.
- **16:9/21:9/32:9:** These formats are for 16:9/21:9/32:9 input sources, like HDTV and DVD enhanced for Wide screen TV.
- **V-Stretch:** This mode stretches a 2.35:1 image vertically removing the black bars.
- **Full Screen:** Use this special 2.0:1 aspect ratio to display both 16:9 and 2.35:1 aspect ratio movies without black bars at the top and bottom of the screen.
- **Auto:** Automatically selects the appropriate display format.

Note:

- Detailed informations about V-Stretch mode:
 - Some Letter-Box Format DVDs are not enhanced for 16x9 TVs. In this situation, the image will not look right when displaying image in 16:9 mode. In this situation, please try to use the 4:3 mode to view the DVD. If the content is not 4:3, there will be black bars around the image in 16:9 display. For this type of content, you can use V-Stretch mode to fill the image on the 16:9 display.
 - If you use an external anamorphic lens, this V-Stretch mode also allows you to watch a 2.35:1 content (include Anamorphic DVD and HDTV film source) that supports anamorphic wide is enhanced for 16x9 Display in a wide 2.35:1 image. In this case, there are no black bars. Light source power and vertical resolution are fully utilized.

USING THE PROJECTOR

- To use the Full Screen format, do the following:
 - a) Set the screen aspect ratio to 2.0:1.
 - b) Select "Full Screen" format.
 - c) Align the projector image correctly on the screen.

4K UHD scaling table:

16 : 9 screen	480i/p	576i/p	720p	1080i/p	2160p
4x3	Scale to 2880 x 2160.				
16x9	Scale to 3840 x 2160.				
LBX	Get the central 3840 x 1620 image, and then scale to 3840 x 2160 for display.				
Native mode	1:1 mapping centered. No scaling will be made; the displayed resolution depends on the input source.				
Auto	-If source is 4:3, the screen type will be scaled to 2880 x 2160. -If source is 16:9, the screen type will be scaled to 3840 x 2160. -If source is 15:9, the screen type will be scaled to 3600 x 2160. -If source is 16:10, the screen type will be scaled to 3456 x 2160.				

Auto mapping rule:

	Input resolution		Auto/Scale	
	H-resolution	V-resolution	3840	2160
4:3	800	600	2880	2160
	1024	768	2880	2160
	1280	1024	2880	2160
	1400	1050	2880	2160
	1600	1200	2880	2160
Wide Laptop	1280	720	3840	2160
	1280	768	3600	2160
	1280	800	3456	2160
SDTV	720	576	2700	2160
	720	480	3240	2160
HDTV	1280	720	3840	2160
	1920	1080	3840	2160

USING THE PROJECTOR

Zoom menu

Use to reduce or magnify an image on the projection screen.

Note: Zoom settings are retained on power cycle of the projector.

Image Shift menu

Adjust the projected image position horizontally (H) or vertically (V).

Note: The image size will reduce slightly when adjusting the horizontal and vertical keystone.

Geometric Correction menu

- **Four Corner:** This setting allows the projected image to be adjusted from each corner to make a square image when the projection surface is not level.
Note: While adjusting the Four Corner, the Zoom, Aspect Ratio, and Image Shift menus are disabled. To enable Zoom, Aspect Ratio, and Image Shift, reset the Four Corner settings to the factory defaults.
- **H Keystone:** Adjust image distortion horizontally and make a squarer image. Horizontal keystone is used to correct a keystone image shape in which the left and right borders of the image are unequal in length. This is intended for use with horizontally on-axis applications.
- **V Keystone:** Adjust image distortion vertically and make a squarer image. Vertical keystone is used to correct a keystone image shape in which the top and bottom are slanted to one of the sides. This is intended when for use with vertically on-axis applications.
- **Auto Keystone:** Automatically adjust image distortion caused by tilting the projector.
- **3x3 Warp:** Adjust the image distortion by 9 points correction.

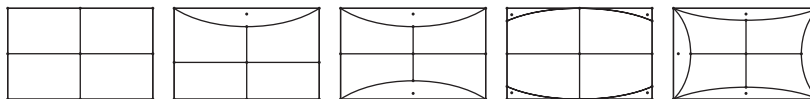

- **Reset:** Return the factory default settings for geometric connection.

Note: When using Enhanced Game Mode, 4 Corner, Horizontal Keystone, Vertical Keystone, and 3x3 warping will be disabled as the settings impact input lag. If you plan to use Enhanced Game Mode for low input lag, we strongly recommend setting up the projector without the use for 4 Corner, Horizontal Keystone, Vertical Keystone, and 3x3 warping.

PureMotion menu

Using sophisticated frame-interpolation technology, PureMotion eliminates motion blurring or image judder, even in high-speed action sequences. Select between Off, 1, 2, 3 for the varying levels on motion smoothing.

Note: PureMotion is supported only if the source is HDMI3.

USING THE PROJECTOR

Audio menu

Audio Mode

Select the appropriate audio mode.

Note:

- *The selected audio mode applies to all sources:*
- *The projector detects automatically Speaker / Audio Out mode.*
- *eARC function is supported only if the source is HDMI1 (IT6807).*
- *If the current input audio format is not PCM, system will resync after audio mode has changed.*

Mute

Use this option to temporarily turn off the sound.

- **Off:** Choose "Off" to turn mute off.
- **On:** Choose "On" to turn mute on.

Note: Mute function affects both internal and external speaker volume.

Volume

Adjust the volume level.

Digital Output Format

Select the appropriate digital output format.

Note:

- *Digital output format can be selected only if the audio mode is set to SPDIF / eARC:*
- *Digital audio mode is supported only if the source is HDMI3 (848).*

Audio Delay

Select the internal speaker audio delay.

Note:

- *Digital output format can be selected only if the audio mode is set to SPDIF / eARC:*
- *Digital audio mode is supported only if the source is HDMI3 (848).*

USING THE PROJECTOR

Setup menu

Projection

Select the preferred projection between front, rear, ceiling-top, and rear-top.

Power Settings

Configure power settings.

- **Direct Power On:** Choose “On” to activate Direct Power mode. The projector will automatically power on when AC power is supplied, without pressing the “Power” key on the projector keypad or on the remote control.
- **Signal Power Off:** Choose “On” to activate Signal Power mode. The projector will automatically power on when a signal is detected, without pressing the “Power” key on the projector Keypad or on the remote control.

Note:

- *This function is applicable with VGA and HDMI sources.*
- *Signal Power On can only be used for one HDMI port at a time. Signal Power On will not work if there is more than one source device connected to the projector. If more than one source device will be used with Signal Power On, please use a HDMI Switch.*
- **Auto Power Off (min):** Sets the countdown timer interval. The countdown timer will start, when there is no signal being sent to the projector. The projector will automatically power off when the countdown has finished (in minutes).
- **Sleep Timer (min.):** Configure the sleep timer.
 - Sleep Timer (min.): Sets the countdown timer interval. The countdown timer will start, with or without a signal being sent to the projector. The projector will automatically power off when the countdown has finished (in minutes).
- **Note:** *The Sleep Timer is reset every time when the projector is powered off.*
 - Always On: Check to set the sleep timer always on.
- **Power Mode (Standby):** Set the power mode setting.
 - Active (SmartHome): Choose “Active (SmartHome)” to return to normal standby.
 - Eco: Choose “Eco.” to save power dissipation further < 0.5W.
- **USB Power (Standby):** Enable or disable the USB power function when the projector is in standby mode.

Security

Configure security settings.

- **Security:** Enable this function to prompt for a password before using the projector.
 - Off: Choose “Off” to be able to switch on the projector without password verification.
 - On: Choose “On” to use security verification when the turning on the projector.
- **Note:** *The default password is 1234.*
- **Security Timer:** Can be select the time (Month/Day/Hour) function to set the number of hours the projector can be used. Once this time has elapsed you will be requested to enter your password again.
- **Change Password:** Use to set or modify the password that is prompted when turning the projector on.

USING THE PROJECTOR

HDMI Link Settings

Note: When you connect HDMI CEC-compatible devices to the projector with HDMI cables, you can control them on the same power on or power off status using the HDMI Link control feature in the projector's OSD. This lets one device or multiple devices in a group power on or power off via HDMI Link Feature in a typical configuration, your DVD player may be connected to the projector through an amplifier or home theater system.

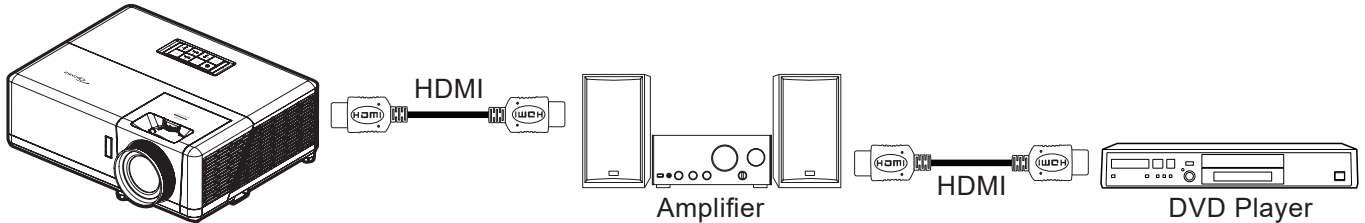

- **HDMI Link:** Enable/disable the HDMI Link function.
- **Inclusive of TV:** If the settings is set to “Yes” then the power on and power off link options are available.
- **Power On Link:** CEC power on command.
 - Mutual: Both projector and CEC device will be turned on simultaneously.
 - PJ → Device: The CEC device will be turned on only after the projector is switched on.
 - Device → PJ: The projector will be switched on only after the CEC device is turned on.
- **Power Off Link:** Enable this function to let both HDMI Link and projector to be automatically turned off at the same time.

Test Pattern

Select the test pattern from green grid, magenta grid, white grid, white, or disable this function (off).

Remote Settings

- **IR Function:** Set the IR function setting.
 - On: Choose “On”, the projector can be operated by the remote control from top and front IR receivers.
 - Off: Choose “Off”, the projector can't be operated by the remote control. By selecting “Off”, you will be able to use the Keypad keys.

Projector ID

ID definition can be set up by menu (range 0-99), and allow user control an individual projector by using RS232 command.

12V Trigger

Use this function to enable or disable the trigger.

Note: 3.5mm mini jack that outputs 12V 500mA (max.) for relay system control.

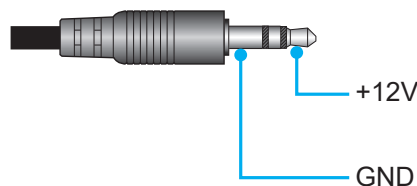

- **On:** Choose “On” to enable the trigger.
- **Off:** Choose “Off” to disable the trigger.

USING THE PROJECTOR

Options

Configure the projector options.

- **Language:** Select the multilingual OSD menu between English, German, French, Italian, Spanish, Portuguese, Simplified Chinese, Traditional Chinese, Japanese, Korean, and Russian.
- **Menu Settings:** Set the menu location on the screen and configure menu timer settings.
 - **Menu Location:** Select the menu location on the display screen.
 - **Menu Timer:** Set the duration where the OSD menu stays visible on the screen.
- **Auto Source:** Choose this option to let the projector automatically find an available input source.
- **Input Source:** Select the input source between HDMI1, HDMI2, HDMI3, and Home.
- **Input Name:** Use to rename the input function for easier identification. The available options include HDMI1, HDMI2, HDMI3, and Home.
- **High Altitude:** When “On” is selected, the fans will spin faster. This feature is useful in high altitude areas where the air is thin.
- **Display Mode Lock:** Choose “On” or “Off” to lock or unlock adjusting display mode settings.
- **Keypad Lock:** When the keypad lock function is “On”, the Keypad will be locked. However, the projector can be operated by the remote control. By selecting “Off”, you will be able to reuse the Keypad.
- **Information Hide:** Enable this function to hide the information message.
 - **Off:** Choose “Off” to show the “searching” message.
 - **On:** Choose “On” to hide the info message.
- **Logo:** Use this function to set the desired startup screen. If changes are made, they will take effect the next time the projector is powered on.
 - **Default:** The default startup screen.
 - **Neutral:** Logo is not displayed on startup screen.
- **Background:** Use this function to display a blue, red, green, gray color, logo, or none when no signal is available.

Reset

Reset the projector.

- **Reset OSD:** Return the factory default settings for OSD menu settings.
- **Reset to Default:** Return the factory default settings for all settings.
- **Android Reset:** Return the factory default settings for for Android settings.

USING THE PROJECTOR

Info menu

View the projector information as listed below:

- Regulatory
- Serial Number
- Source
- Resolution
- Refresh Rate
- Display Mode
- Projector ID
- Brightness Mode
- FW Version
- MAC Address

USING THE PROJECTOR

System settings menu

On the Home screen, select the system settings menu “” to configure various system settings.

General menu navigation

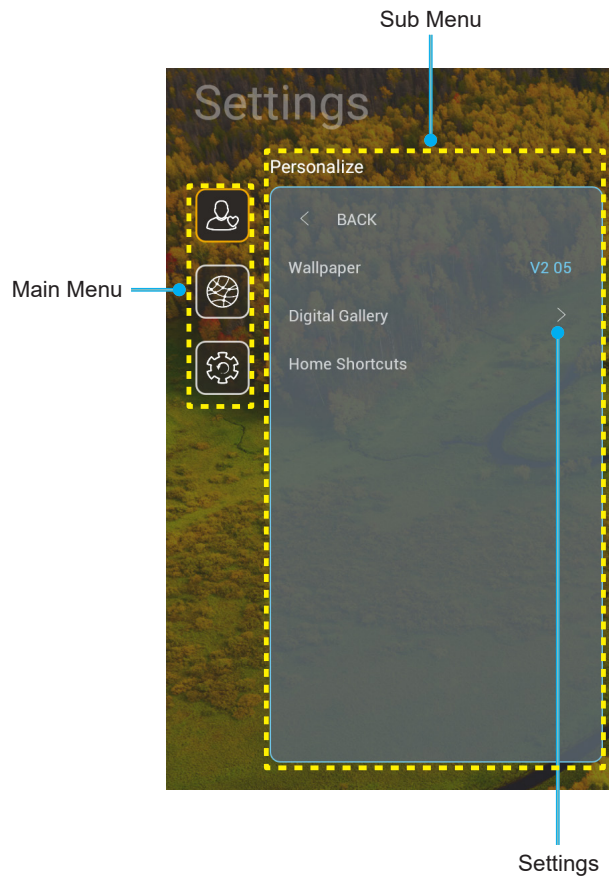

1. When system settings menu is displayed, use the up and down navigation buttons to select any item in the main menu. While making a selection on a particular page, press the “**OK**” or the “**Right**” button on the remote control to enter the submenu.
2. Press the “**Left**” and “**Right**” button to select the desired menu item. Then press “**OK**” to open its sub menu.
3. Press the “**Up**” and “**Down**” button to select the desired item in the sub menu.
4. Press the “**OK**” or “**Right**” button to access the selected sub menu item settings.
5. Press the “**Up**”, “**Down**”, “**Left**”, or “**Right**” button to select the setting or press the “**Left**” and “**Right**” button to adjust the value (if necessary).
6. Press “**OK**” to confirm the setting.
7. Select the next item to be adjusted in the sub menu and modify as described above.
8. To exit, press “**↩**” (repeatedly if necessary). The settings menu will close and the projector will automatically save the new settings.

USING THE PROJECTOR

System settings menu tree

Level 1	Level 2	Level 3	Level 4	Value		
Personalize	Wallpaper	Optoma style...				
	Home Shortcut		Short cut 1		APP/ Input Source	
			Short cut 2		APP/ Input Source	
			Short cut 3		APP/ Input Source	
			Short cut 4		APP/ Input Source	
			Short cut 5		APP/ Input Source	
			Short cut 6		APP/ Input Source	
	Screensaver		Screensaver		Off	
					On	
			Start after		3mins	
					5mins	
					10mins	
	Network	Wireless	Wi-Fi		Off	
					On [Default]	
Available Networks SSID (When WiFi On)				Enter password for [Wi-Fi name] (When entering password)		[Pop up dialog] - Title: Enter password for [Wi-Fi name] - Subtitle: Password - Input: (Input text) - Checkbox: Show password - Button: "Cancel"/ "OK"
					Internet Connection	
					IP Address	
					MAC Address	
					Signal Strength	
					Proxy Settings	None
				Manual		[Pop up dialog] Title: Enter a valid hostname. Subtitle: Proxy hostname Input hint: proxy.example@com Button: "Cancel"/ "OK"
				IP Settings		DHCP
					Static	[Pop up dialog] Title: Enter a valid IP address. Subtitle: IP address Input hint: 192.168.1.128 Button: "Cancel"/ "OK"
				Cancel		
				Forget	[Pop up dialog] Hint: [Wi-Fi name] Title: Forget network Content: Your device will no longer join this Wi-Fi network. Button: "Cancel"/ "OK"	

USING THE PROJECTOR

Level 1	Level 2	Level 3	Level 4	Value	
Network	Wireless	Other Options	Connect via WPS		
			Connect via WPS (Enter PIN)		
			Add New Network	[Pop up dialog] Title: Enter the name for Wi-Fi network Input: (Input text) Button: "Cancel"/ "OK"	
				[Pop up dialog] Content: Type of security Button: None, WEP, WPA/WPA2 PSK, 802.1xEAP	
			Portable Hotspot	Portable Wi-Fi Hotspot	Off
					On
				Network name	[Pop up dialog] Title: Rename network name Input: (Input text) Button: "Cancel"/"OK"
				Security	[Pop up dialog] Title: Type of security Button: None, WPA2 PSK
				Password	[Pop up dialog] Title: Change password Input: (Input text) Description: The password must have at least 8 characters. Checkbox: Show password Button: "Cancel"/"OK"
			Ethernet	Network Status	
	MAC Address			(read only)	
	Proxy Settings	None			
		Manual		Proxy hostname	
				Port	
		bypass proxy domains			
	IP Settings	DHCP			
		Static		IP address	
			Gateway		
			Network Prefix Length		
	DNS1				
	DNS2				
Reset					

USING THE PROJECTOR

Level 1	Level 2	Level 3	Level 4	Value
System	Keyboard			
	Date and Time Settings	Select time zone		-12:00, -11:00, -10:00, -09:30, -09:00, -08:00, -07:00, -06:00, -05:00, -04:00, -03:30, -03:00, -02:00, -01:00, 00:00, +01:00, +02:00, +03:00, +03:30, +04:00, +04:30, +05:00, +05:30, +05:45, +06:00, +06:30, +07:00, +08:00, +08:30, +8:45, +09:00, +09:30, +10:00, +10:30, +11:00, +12:00, +12:45, +13:00, +14:00
		Daylight Saving Time		On
				Off [Default]
		Use 24-hour format		On
			Off [Default]	
	System Update			
	Internal Storage			
	Legal	Terms and Conditions of Use		
		Privacy Policy		
		Cookies Policy		
Open Source License				
Control	LAN Control	Smart Home		Off [Default]
				On

Note:

- *Functions vary depending on model definition.*
- *Disabling Smart Home will disable the ability to power on the projector using Alexa Smart Home or Google Action “power on” command (Example: Alexa, turn on projector).*

USING THE PROJECTOR

Personalize menu

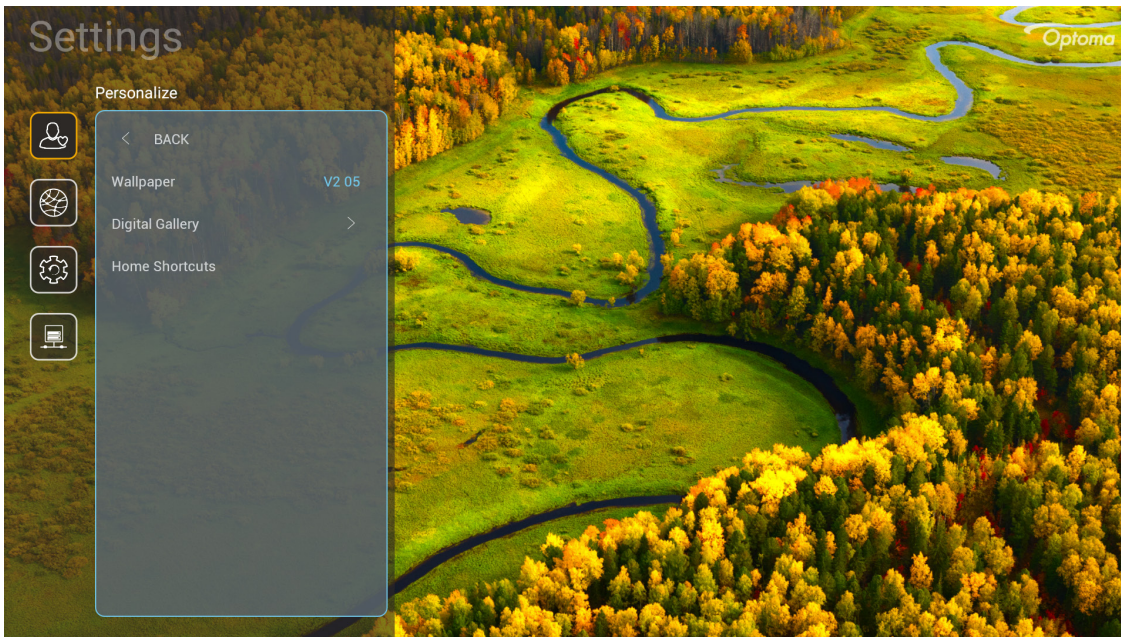

Home Shortcut

Review Home screen shortcuts of all opened apps in each input source. The items cannot repeat except for “Automatic” option which means the system will remember up to six latest apps that have been opened and then will replace app shortcuts so that the latest app will be the first app in the apps list while other apps in the list are shifted by one position.

Screensaver

Blanks the screen when the projector has been idle for a long time.

- **Screensaver:** Choose “On” to enable the Screensaver function.
- **Start after:** Set the wait time before activating the Screensaver function.

USING THE PROJECTOR

Network menu

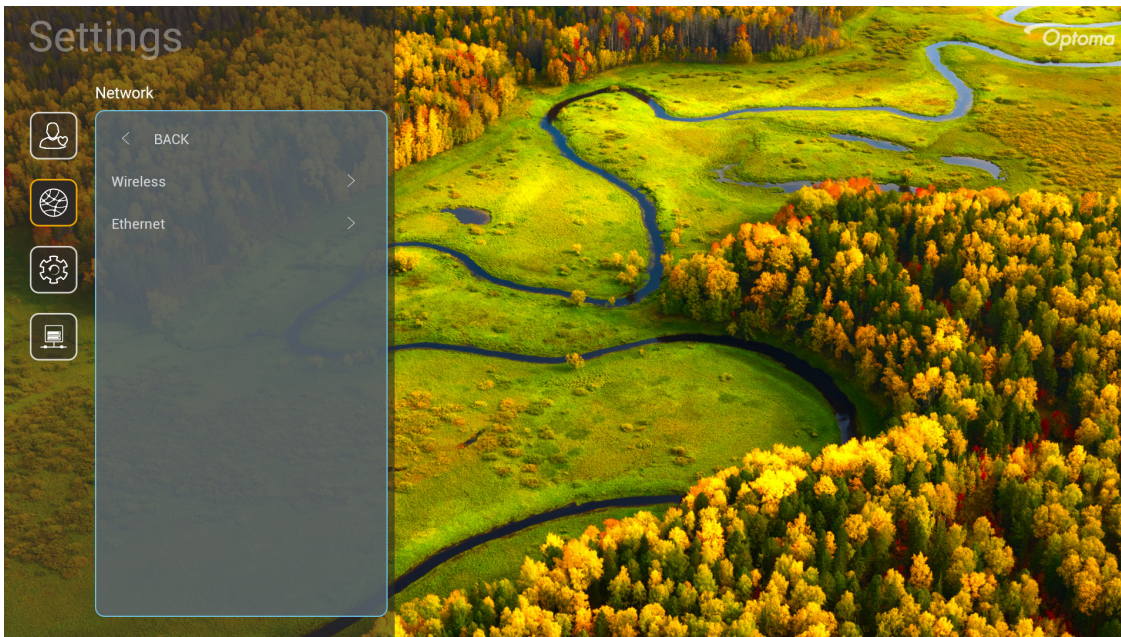

Wireless

Configure wireless network settings.

- **Wi-Fi:** Set the Wi-Fi option to “On” to enable wireless network feature.
- **Available Network SSID:** Select your desired wireless access point and enter or configure the necessary connection parameters (if required), for example password, proxy settings, and IP address. For information, you can review the signal strength.
Choose “Cancel” to return to the Network menu without saving settings. Choose “Forget” to delete the wireless network profile.
Note: *Whenever you need to input symbols, the system will automatically pop-up an onscreen keyboard.*
- **Other Options:** Configure advanced wireless network settings, such as “Connect via WPS”, “Connect via WPS (Enter PIN)”, “Add New Network” (manually enter network name), and “Portable Hotspot” (configure the projector to behave as a wireless access point for other devices).

Ethernet

Configure wired network settings.

Note: *Make sure you have connected the projector to local area network (LAN). Please refer to page 16.*

- **Network Status:** Display the network connection status (read-only).
- **MAC Address:** Display the MAC address (read-only).
- **Proxy Settings:** Provide proxy hostname, connection port and bypass proxy domains information manually if requested.
- **IP Settings:** Enable DHCP if you want the projector to obtain IP address and other connection parameters automatically from your network. Disable DHCP if you want to assign IP address, gateway, network prefix length, and DNS parameters manually.
- **Reset:** Return the factory default settings for network settings.

USING THE PROJECTOR

System menu

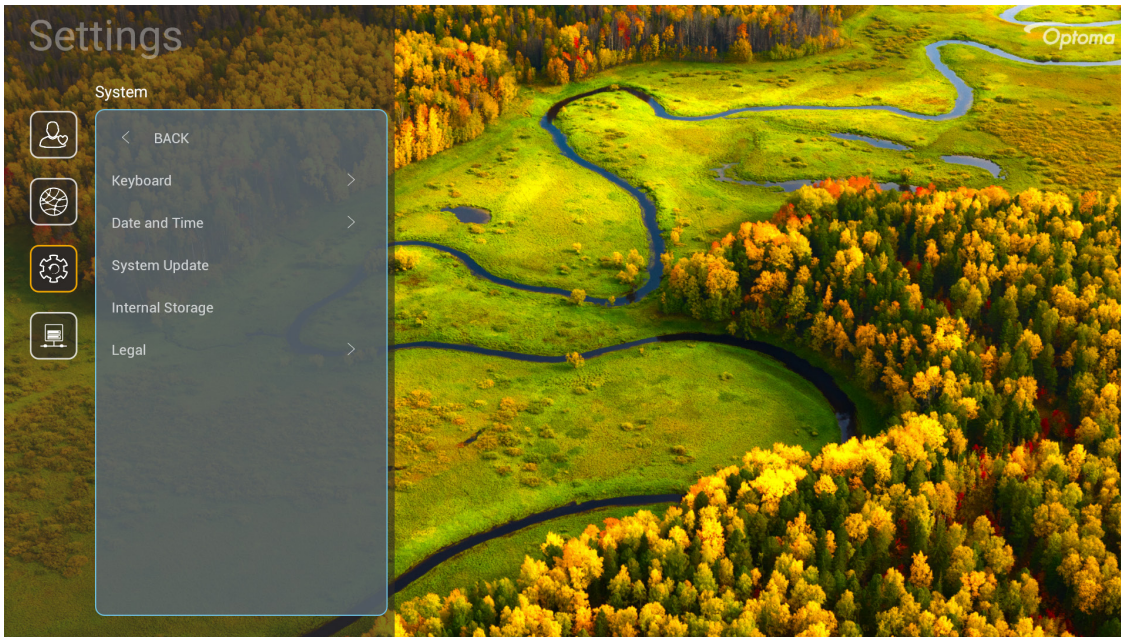

Keyboard

Select the keyboard language.

Date and Time

Configure date and time settings.

- **Select time zone:** Select the time zone in your location.
- **Daylight Saving Time:** Set to “On” if daylight saving time is observed in your region.
- **Use 24-hour format:** Set to “On” to display time in 24-hour format. Set to “Off” to display time in 12-hour format (AM/PM).

System Update

System will look for updates automatically every time the projector is connected to the Internet (OTA).

Internal Storage

View the remaining internal storage space.

Legal

Review legal documents including “Terms and Conditions of Use”, “Privacy Policy”, and “Cookies Policy”.

Note: You can review legal documents online as well. Please refer to the following web addresses:

- Terms and Conditions of Use: <https://www.optoma.com/terms-conditions/> .
- Cookies Policy: <https://www.optoma.com/cookies-policy/> .
- Privacy Policy: <https://www.optoma.com/software-privacy-policy/> .
- Open Source License

Control menu

LAN Control

- **SmartHome:** Set to “Off” to turn off all control via “IoT”, including “InfoWall”.

USING THE PROJECTOR

Selecting an input source

You can select any input source directly on the Home screen using an input shortcut.

Note: You can personalize shortcut settings in “System Settings menu → Personalize → Home Shortcut”. You can also modify the shortcut order on the Home screen.

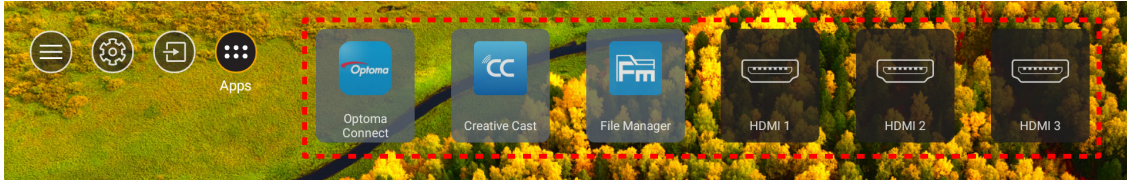

If the desired input source is not visible on the Home screen, select “” to view all input options. Then select your input source or select “Home” to return to the Home screen.

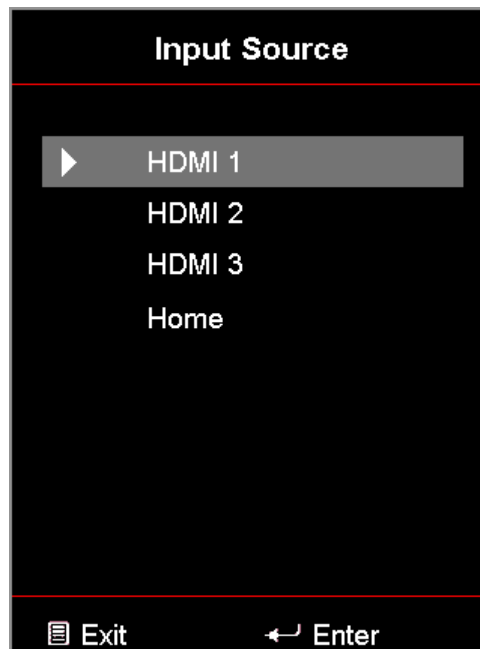

USING THE PROJECTOR

Selecting an app

You can select any app directly on the Home screen using an app shortcut.

Note: You can personalize shortcut settings in “System Settings menu → Personalize → Home Shortcut”.

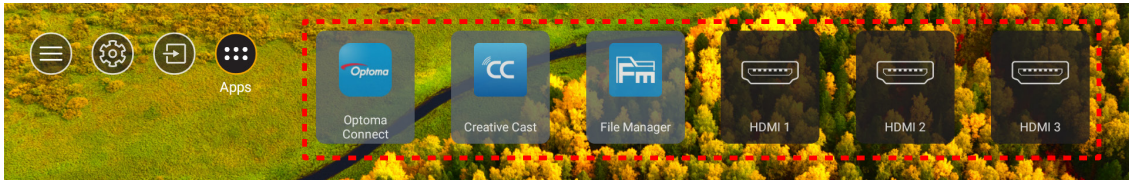

If the desired app is not visible on the Home screen, select “” to view all installed apps. Then select your desired app.

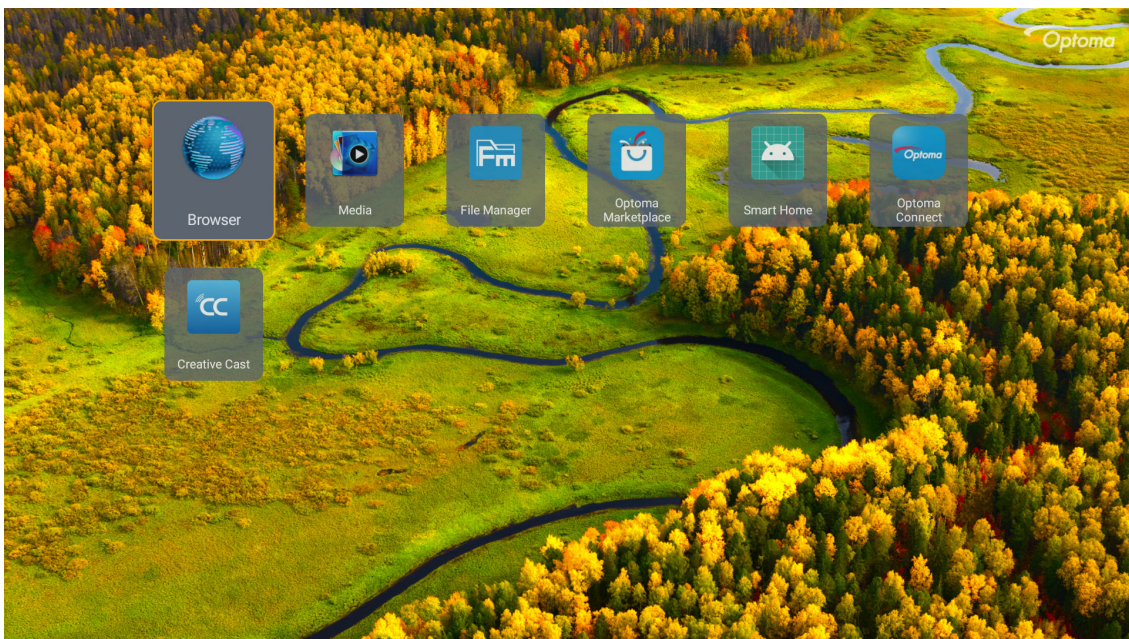

USING THE PROJECTOR

Creative Cast

To get the App, you can do either of the following:

- if you are using the mobile device, scan the QR code on the screen.
- if you are using the computer, simply go to the link.

Then install the Creative Cast app in your computer or mobile device.

Before you get started, make sure to connect your computer or mobile device to the same Wi-Fi as the projector. Then follow the on-screen instructions to operate the App.

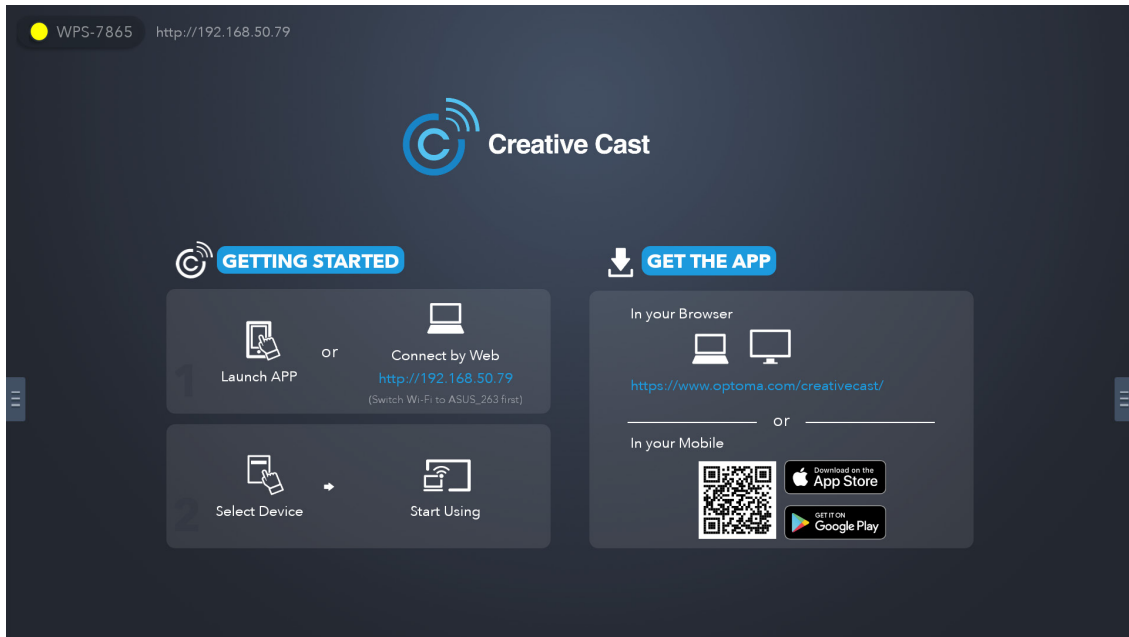

Note: For initial activation of the iOS screen mirroring function, please ensure the projector is connected to the internet, then launch the Creative Cast app. You are only required to perform this initial step once and after the initial connection is established, the Creative Cast app does not need to be open for future use of the iOS screen mirroring function.

USING THE PROJECTOR

Optoma Marketplace

With the Optoma Marketplace app, you can search and install any App.

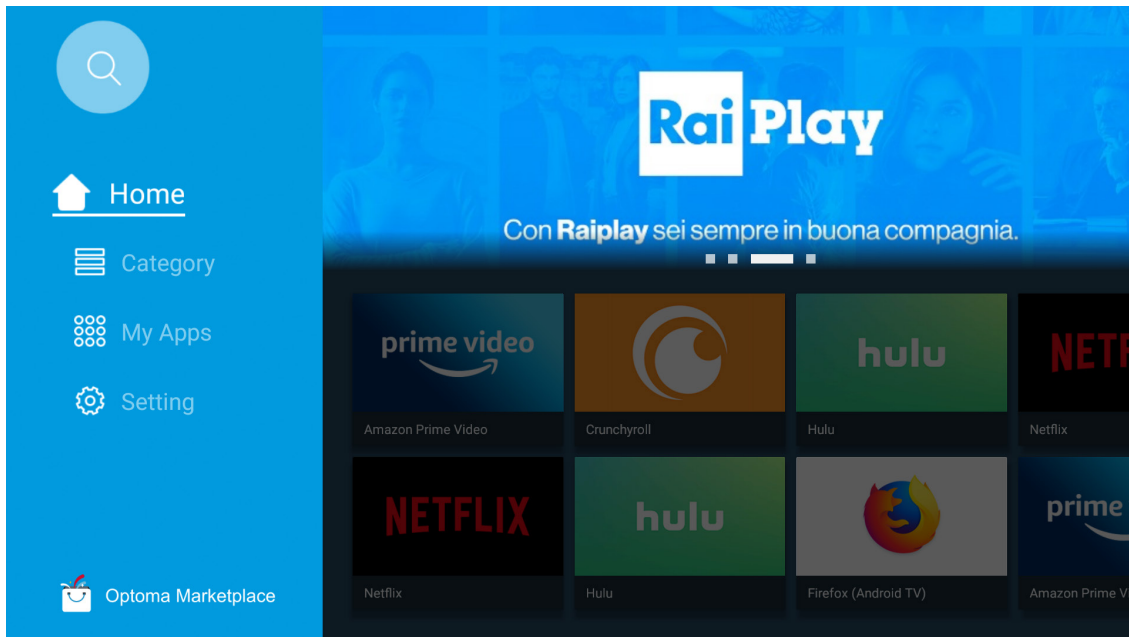

File Manager

With the File Manager app, you can manage the files stored in the internal storage, external storage, and cloud storage.

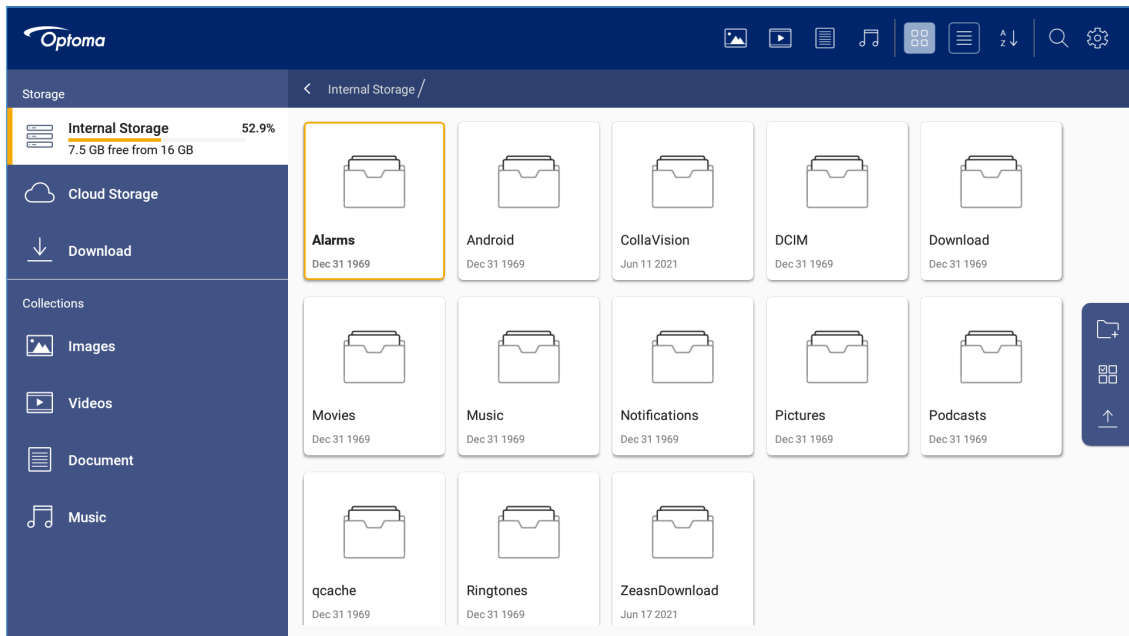

USING THE PROJECTOR

Media

With the Media app, you can play the multimedia files by connecting a USB storage with multimedia content to the projector. Then open the multimedia player app and select the desired files to play.

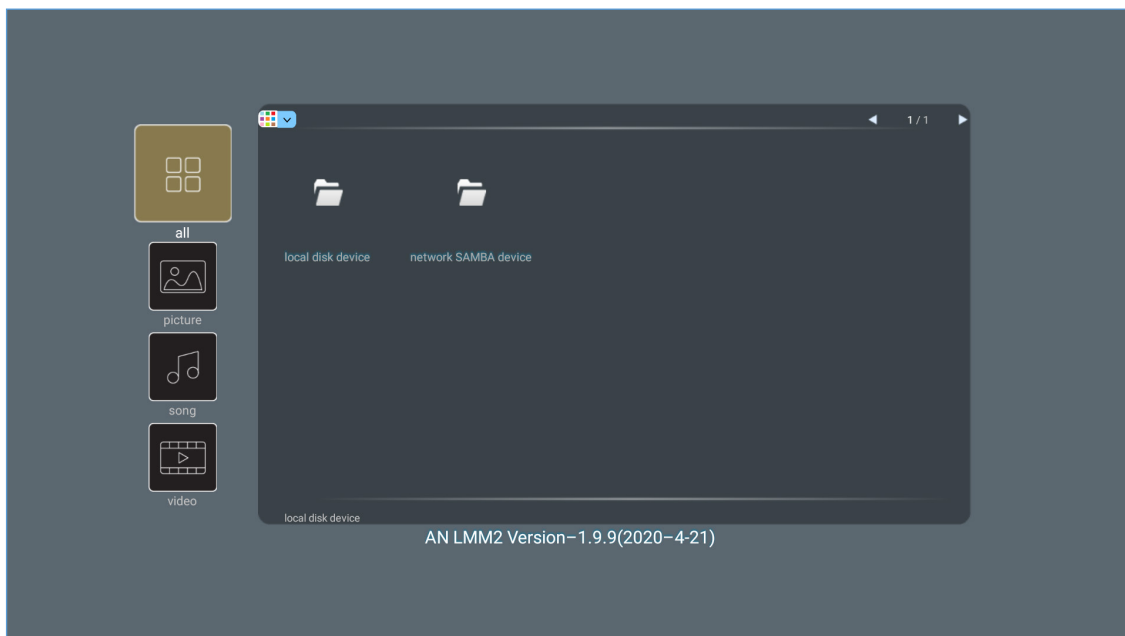

USING THE PROJECTOR

Supported multimedia formats

If you want to play multimedia files, connect a USB storage with multimedia content to the projector. Then open the multimedia player app and select the desired files to play.

The projector supports the following multimedia formats:

Media Category	Decoder	Supported File Formats
Video	H.263	MOV
		3GP
		AVI
		MKV
	H.264	FLV
		MP4
		MOV
		3GP
		MPEG transport stream (.ts / .trp / .tp)
		ASF
		WMV
		AVI
		MKV
		HEVC/H.265
	MOV	
	MPEG transport stream (.ts / .trp / .tp)	
	MKV	
	MPEG1/2	MPEG program stream (.DAT / .VOB / .MPG / .MPEG)
		MPEG transport stream (.ts / .trp / .tp)
		MP4
		AVI
		MKV
	MPEG4	MP4
		MOV
		3GP
		AVI
		MKV
	Motion JPEG	AVI
		MP4
		MOV
AVS	MP4	
VC1	WMV	

USING THE PROJECTOR

Media Category	Decoder	Supported File Formats
Audio	MPEG1/2 Layer2	AVI
		Matroska (MKV, MKA)
		MP4
		MOV
		MPEG transport stream (.ts / .trp / .tp)
		MPEG program stream (.DAT / .VOB / .MPG / .MPEG)
	MPEG1/2/2.5 Layer3	MP3
		Matroska (MKV, MKA)
		MP4
	MPEG1/2/2.5 Layer3	MOV
		MPEG transport stream (.ts / .trp / .tp)
		MPEG program stream (.DAT / .VOB / .MPG / .MPEG)
	AC3	AC3
		Matroska (MKV, MKA)
		MOV
		MPEG transport stream (.ts / .trp / .tp)
		MPEG program stream (.DAT / .VOB / .MPG / .MPEG)
	EAC3	MP4
	AAC, HEAAC	AAC
		MP4
		MOV
		M4A
		MPEG transport stream (.ts / .trp / .tp)
LPCM	WAV	
	AVI	
	Matroska (MKV, MKA)	
IMA-ADPCM MS-ADPM	WAV	
	AVI	
	Matroska (MKV, MKA)	
	MP4	
FLAC	Matroska (MKV, MKA)	
Photo	BMP	15360 X 8640 (The limitaion of max resolution depends on DRAM size)

Note:

- All multimedia files listed above.
- Dolby output from video files is not supported.

Picture

Image Type (Ext name)	Sub Type	Maximum Pixels
Jpeg / Jpg	Baseline	8000 x 8000
	Progressive	6000 x 4000
PNG	Non-interlace	6000 x 4000
	Interlace	6000 x 4000
BMP		6000 x 4000

USING THE PROJECTOR

Doc

Document Format	Support Version and Format	Pages/Lines Limitation	Size Limitation
PDF	PDF 1.0 ~ 1.7 and above	Up to 1500 pages (One File)	Up to 100MB
Word	Kingsoft Writer Document (*.wps)	Since WPS Projector does not load the MS/Word files all at one time, there is no obvious limitation on the number of pages and rows of files.	Up to 150MB
	Kingsoft Writer Template (*.wpt)		
	Microsoft Word 97/2000/XP/2003 Document (*.doc)		
	Microsoft Word 97/2000/XP/2003 Template (*.dot)		
	RTF Files (*.rtf)		
	Text Files (*.txt, *.log, *.lrc, *.c, *.cpp, *.h, *.asm, *.s, *.java, *.asp, *.prg, *.bat, *.bas, *.cmd)		
	Web Page Files (*.html, *.htm)		
	Single Web Page Files (*.mht, *.mhtml)		
	Microsoft Word 2007/2010 Document (*.docx)		
	Microsoft Word 2007/2010 Template (*.dotx)		
	Microsoft Word 2007/2010 Macro-Enabled Document (*.docm)		
	Microsoft Word 2007/2010 Macro-Enabled Template (*.dotm)		
	XML Files (*.xml)		
	OpenDocument Text		
Works 6-9 Document (*.wtf)			
Works 6.0&7.0 (*.wps)			
Excel	Kingsoft Spreadsheets Files (*.et)	Row Limit: up to 65,535 Column Limit: up to 256 Sheet: up to 200	Up to 30MB
	Kingsoft Spreadsheets Template (*.ett)		
	Microsoft Excel 97/2000/XP/2003 Workbook (*.xls)		
	Microsoft Excel 97/2000/XP/2003 Template (*.xlt)		
	Text Files (*.csv)		
	Web Pages (*.htm, *.html)		
	XML Files (*.xml)		
	Microsoft Excel 2007/2010 Files (*.xlsx, *.xlsm)		
	Microsoft Excel 2007/2010 Template (*.xltx)		
Microsoft Excel 2007/2010 Binary Workbook (*.xlsb)			
PowerPoint	Kingsoft Presentation Files (*.dps)	Up to 1500 pages (One File)	Up to 30MB
	Kingsoft Presentation Templates (*.dpt)		
	Microsoft PowerPoint 97/2000/XP/2003 Presentations (*.ppt, *.pps)		
	Microsoft PowerPoint 97/2000/XP/2003 Presentation Templates (*.pot)		
	Microsoft PowerPoint 2007/2010 Presentations (*.pptx, *.ppsx)		
	Microsoft PowerPoint 2007/2010 Presentations Template (*.potx)		

Note:

- Decoding may take a while for large files with complex contents.
- Objects embedded in files cannot be activated or viewed.

USING THE PROJECTOR

- *For Microsoft Word*
 - *No support for advanced settings, such as drawing plug-in or table background settings.*
 - *Contents outside the defined borders in Microsoft Word will not be displayed.*
 - *Not support Bold Text in Simplified Chinese font.*
- *For Microsoft PowerPoint*
 - *Slide effects not supported.*
 - *Password-protected sheets are not protected.*
 - *Powerpoint animation is not supported.*
- *For Microsoft Excel*
 - *Worksheets are displayed individually and sequentially when the workbook has multiple worksheets.*
 - *Page layout and numbering may be changed during decoding.*

USING THE PROJECTOR

Viewing the status bar

By default, the Status Bar on the Home screen contains icons indicating connection status regarding wired network, USB, and wireless network. You can select any of the icons to open the associated menu. Selecting wired or wireless status icon results in opening the network configuration menu, while selecting the USB status icon results in opening the browser and displaying the content of the connected USB device.

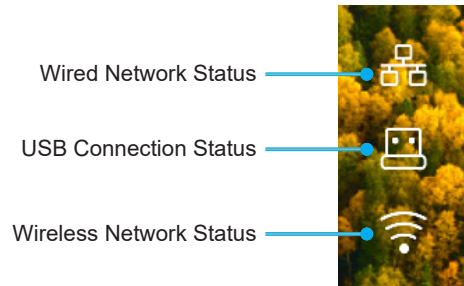

Alexa / Google Assistant

This projector supports the Voice control feature such as Alexa / Google Assistant.

User can search keyword by “Optoma connect & alexa” & “Optoma connect & google assistant” to get Alexa and Google setup guide on the website by clicking the following link:

- [Optoma Connect app - Alexa setup tutorial](#)
- [Optoma Connect app - Google setup tutorial](#)

ADDITIONAL INFORMATION

Compatible resolutions

Video compatibility

Signal	Resolution
SDTV	480i/p, 576i/p
HDTV	720p (50/60Hz), 1080i (50/60Hz), 1080p (24/50/60Hz)
UHD	2160p (24/50/60Hz)

Video timing in details:

Signal	Resolution	Refresh Rate (Hz)	Notes
SDTV (480i)	640 x 480	60	For Component
SDTV (480p)	640 x 480	60	
SDTV (576i)	720 x 576	50	
SDTV (576p)	720 x 576	50	
HDTV (720p)	1280 x 720	50/60	
HDTV (1080i)	1920 x 1080	50/60	
HDTV (1080p)	1920 x 1080	24/50/60/240	
WQHD(1440p)	2560x1440	120	
UHD (2160p)	3840 x 2160	24/50/60	For 4K UHD

Computer compatibility

VESA standards (Computer Signal (Analog RGB compatibility)):

Signal	Resolution	Refresh Rate (Hz)	Notes for Mac
SVGA	800 x 600	56/60/72	Mac 60/72
XGA	1024 x 768	60/70/75	Mac 60/70/75
HDTV(720p)	1280 x 720	50/60	Mac 60
WXGA	1280 x 768	60/75	Mac 60/75
WXGA	1280 x 800	60	Mac 60
WXGA	1366 x 768	60	Mac 60
WXGA+	1440 x 900	60	Mac 60
SXGA	1280 x 1024	60/75	Mac 60/75
UXGA	1600 x 1200	60	
HDTV(1080p)	1920 x 1080	24/50/60	Mac 60
WUXGA	1920 x 1200 (*)	60	Mac 60

Note: (*)1920 x 1200 @60Hz only supports RB(reduced blanking).

ADDITIONAL INFORMATION

Timing table for PC:

Signal	Resolution	Frequency H.	Refresh Rate	Video	Digital	Note
		(KHz)	(Hz)			
SVGA	800 x 600	35.2	56.3	N/A	√	56Hz
SVGA	800 x 600	37.9	60.3	N/A	√	60Hz
SVGA	800 x 600	46.9	75	N/A	√	N/A
SVGA	800 x 600	48.1	72.2	N/A	√	72Hz
SVGA	800 x 600	53.7	85.1	N/A	√	85Hz
SVGA	832 x 624		75	N/A	√	N/A
XGA	1024 x 768	48.4	60	N/A	√	N/A
XGA	1024 x 768	56.5	70.1	N/A	√	70Hz
XGA	1024 x 768	60	75	N/A	√	N/A
XGA	1024 x 768	68.7	85	N/A	√	N/A
XGA	1024 x 768		120	N/A	N/A	N/A
SXGA	1152 x 864		75	N/A	√	N/A
HD720	1280 x 720		50	N/A	√	N/A
HD720	1280 x 720		60	N/A	√	N/A
HD720	1280 x 720	92.62	120	N/A	N/A	N/A
WXGA	1280 x 768	47.4	60	N/A	√	N/A
WXGA	1280 x 768		75	N/A	√	N/A
WXGA	1280 x 768		85	N/A	√	N/A
WXGA-800	1280 x 800		60	N/A	√	N/A
SXGA	1280 x 1024	64	60	N/A	√	N/A
SXGA	1280 x 1024	80	75	N/A	√	N/A
SXGA	1280 x 1024	91.1	85	N/A	√	N/A
SXGA+	1400 x 1050		60	N/A	N/A	N/A
UXGA	1600 x 1200	75	60	N/A	√	N/A
HD1080	1920 x 1080		24	N/A	√	N/A
HD1080	1920 x 1080		50	N/A	√	N/A
HD1080	1920 x 1080		60	N/A	√	N/A
WUXGA	1920 x 1200		60	N/A	√	RB
HDTV	1920 x 1080i		50	√	√	N/A
HDTV	1920 x 1080i		60	√	√	N/A
HDTV	1920 x 1080p		24	√	√	N/A
HDTV	1920 x 1080p		50	√	√	N/A
HDTV	1920 x 1080p		60	√	√	N/A
HDTV	1280 x 720	45	60	√	N/A	N/A
HDTV	1280 x 720p		50	√	√	N/A
HDTV	1280 x 720p		60	√	√	N/A
SDTV	720 x 576	31.3	50	√	N/A	N/A
SDTV	720 x 576i		50	N/A	√	N/A
SDTV	720 x 576p		50	N/A	√	N/A
SDTV	720 x 480	31.5	60	√	N/A	N/A
SDTV	720 x 480i		60	N/A	√	N/A
SDTV	720 x 480p		60	N/A	√	N/A

Note: “√” means the resolution is supported, “N/A” means the resolution is not supported.

ADDITIONAL INFORMATION

Computer Compatibility for MAC

Resolution	Hz	Macbook Compatibility	Macbook Pro (Intel) Compatibility	Power Mac G5 Compatibility	Power Mac G4 Compatibility
		Digital	Digital	Digital	Digital
800x600	60	√	√	N/A	√
800x600	72	√	√	N/A	√
800x600	75	√	√	N/A	√
800x600	85	√	N/A	N/A	√
1024x768	60	√	√	N/A	√
1024x768	70	√	√	N/A	√
1024x768	75	√	√	N/A	√
1024x768	85	√	√	N/A	√
1280x720	60	√	√	N/A	√
1280x768	60	√	√	N/A	N/A
1280x768	75	N/A	N/A	N/A	√
1280x768	85	N/A	N/A	N/A	N/A
1280x800	60	N/A	N/A	N/A	√
1280x1024	60	√	N/A	N/A	√
1280x1024	75	√	N/A	N/A	√
1920x1080	60	√	N/A	N/A	√
1920x1200 (*)	60	√	N/A	N/A	√
3840 x 2160	60	N/A	N/A	N/A	N/A

Note:

- (*) 1920 x 1200 @ 60Hz only supports RB (reduced blanking).
- “√” means the resolution is supported, “N/A” means the resolution is not supported.

Input signal for HDMI

Signal	Resolution	Refresh Rate (Hz)	Notes for Mac
SVGA	800 x 600	60/72/85/120	Mac 60/72/85
XGA	1024 x 768	60/70/75/85/120	Mac 60/70/75/85
SDTV(480I)	640 x 480	60	
SDTV(480P)	640 x 480	60	
SDTV(576I)	720 x 576	50	
SDTV(576P)	720 x 576	50	
HDTV(720p)	1280 x 720	50/60	Mac 60
WXGA	1280 x 768	60/75/85	Mac 75
WXGA	1280 x 800	60/120	Mac 60
WXGA(*2)	1366 x 768	60	
WXGA+	1440 x 900	60/120(RB)	Mac 60
SXGA	1280 x 1024	60/75/85	Mac 60/75
SXGA+	1400 x 1050	60/85	
UXGA	1600 x 1200	60/65/70/75/85	
HDTV(1080I)	1920 x X1080	50/60	
HDTV(1080p)	1920 x 1080	24/30/50/60/120/240	Mac 60
WUXGA	1920 x 1200(*1)	60	Mac 60RB
WQHD	2560 x 1440	60RB/120	

ADDITIONAL INFORMATION

Signal	Resolution	Refresh Rate (Hz)	Notes for Mac
UHD(2160p)	3840 x 2160	24/30/50/60	Mac 24/30
UHD(2160p)	4096 x 2160	24/30/50/60	Mac 24

Note:

- (*1) 1920 x 1200 @ 60Hz only supports RB(reduced blanking).
- (*2) Windows 10 standard timing.

Extended Display Identification Data (EDID) tables

Digital signal (HDMI 2.0)

Digital Native resolution: 3840 x 2160 @ 60Hz

B0/Established Timing	B0/Standard Timing	B0/Standard Timing	B1/Video Mode	B1/Detail Timing
800 x 600 @ 56Hz	1280 x 720 @ 60Hz	3840 x 2160 @ 60Hz (default)	1920 x 1080p @ 120Hz 16:9	2560 x 1440 @ 120Hz
800 x 600 @ 72Hz	1280 x 800 @ 60Hz		720 x 480p @ 60Hz 4:3	1920 x 1080 @ 240Hz
800 x 600 @ 75Hz	1280 x 1024 @ 60Hz		1920 x 1080i @ 60Hz 16:9	
832 x 624 @ 75Hz	1920 x 1200 @ 60Hz		1920 x 1080i @ 50Hz 16:9	
1024 x 768 @ 60Hz	800x600 @ 120Hz		1920 x 1080p @ 60Hz 16:9	
1024 x 768 @ 70Hz	1024x768 @ 120Hz		1920 x 1080p @ 50Hz 16:9	
1024 x 768 @ 75Hz	1280x800 @ 120Hz		1920 x 1080p @ 24Hz 16:9	
1280 x 1024 @ 75Hz			3840 x 2160 @ 24Hz 16:9	
1152 x 870 @ 75Hz			3840 x 2160 @ 25Hz 16:9	
			3840 x 2160 @ 30Hz 16:9	
			3840 x 2160 @ 50Hz 16:9	
			3840 x 2160 @ 60Hz 16:9	
			4096 x 2160 @ 24Hz	
			4096 x 2160 @ 25Hz	
			4096 x 2160 @ 30Hz	
			4096 x 2160 @ 50Hz	
			4096 x 2160 @ 60Hz	
			720 x 480p @ 60Hz 16:9	
			1280x720p @ 60Hz 16:9	
			1280 x 720p @ 50Hz 16:9	

Note: Support 1920 x 1080 @ 50Hz

ADDITIONAL INFORMATION

3D Timing

For Blu-ray 3D (HDMI 1.4a):

2D Support Frame Rate	Timing	Format
59/60 Hz option:	1920 x 1080p @ 23.98 / 24Hz	Frame packing (HDMI1/HDMI2)
	1280 x 720p @ 59.94 / 60Hz	Frame packing (HDMI1/HDMI2)
	1920 x 1080p @ 23.98 / 24Hz	Top-and-Bottom (HDMI2/VGA)
	1280 x 720p @ 59.94 / 60Hz	Top-and-Bottom (HDMI2/VGA)
	1920 x 1080p @ 23.98 / 24Hz	Side-by-Side (HDMI2/VGA)
	1280 x 720p @ 59.94 / 60Hz	Side-by-Side (HDMI2/VGA)
50 Hz option:	1920 x 1080p @ 23.98 / 24Hz	Frame packing (HDMI1/HDMI2)
	1280 x 720p @ 50Hz	Frame packing (HDMI1/HDMI2)
	1920 x 1080p @ 23.98 / 24Hz	Top-and-Bottom (HDMI2/VGA)
	1280 x 720p @ 50Hz	Top-and-Bottom (HDMI2/VGA)
	1920 x 1080p @ 23.98 / 24Hz	Side-by-Side (HDMI2/VGA)
	1280 x 720p @ 50Hz	Side-by-Side (HDMI2/VGA)

For PC:

Input	Timing	Format
HDMI1	1920 x 1080 @ 120Hz	Frame Sequential
	1280 x 800 @ 120Hz	Frame Sequential
	1024 x 768 @ 120Hz	Frame Sequential
	800 x 600 @ 120Hz	Frame Sequential
HDMI2	1920 x 1080 @ 60Hz	Frame Sequential
	1280 x 800 @ 120Hz	Frame Sequential
	1280 x 720 @ 120Hz	Frame Sequential
	1024 x 768 @ 120Hz	Frame Sequential

ADDITIONAL INFORMATION

Image size and projection distance

Diagonal length (inch) size of 16:9 Screen	Screen Size W x H				Projection Distance (D)				Offset (Hd)			
	(m)		(inch)		(m)		(feet)					
	Width	Height	Width	Height	Wide	Tele	Wide	Tele	(m) (min.)	(feet) (min.)	(m) (max.)	(feet) (max.)
30	0.66	0.37	26.15	14.71	-	1.06	-	3.46	0.02	0.06	0.06	0.18
40	0.89	0.50	34.86	19.61	1.07	1.41	3.51	4.62	0.02	0.08	0.07	0.25
60	1.33	0.75	52.29	29.42	1.61	2.11	5.27	6.93	0.04	0.12	0.11	0.37
70	1.55	0.87	61.01	34.32	1.88	2.46	6.15	8.08	0.04	0.14	0.13	0.43
80	1.77	1.00	69.73	39.22	2.14	2.82	7.03	9.23	0.05	0.16	0.15	0.49
90	1.99	1.12	78.44	44.12	2.41	3.17	7.91	10.39	0.06	0.18	0.17	0.55
100	2.21	1.25	87.16	49.03	2.68	3.52	8.78	11.54	0.06	0.20	0.19	0.61
120	2.66	1.49	104.59	58.83	3.21	4.22	10.54	13.85	0.07	0.25	0.22	0.74
150	3.32	1.87	130.74	73.54	4.02	5.28	13.18	17.31	0.09	0.31	0.28	0.92
180	3.98	2.24	156.88	88.25	4.82	6.34	15.81	20.78	0.11	0.37	0.34	1.10
200	4.43	2.49	174.32	98.05	5.36	7.04	17.57	23.08	0.12	0.41	0.37	1.23
250	5.53	3.11	217.89	122.57	6.70	8.80	21.96	28.85	-	-	-	-
301	6.65	3.74	262.00	147.37	8.05	-	26.40	-	-	-	-	-

Note: These values are not exact and can vary slightly.

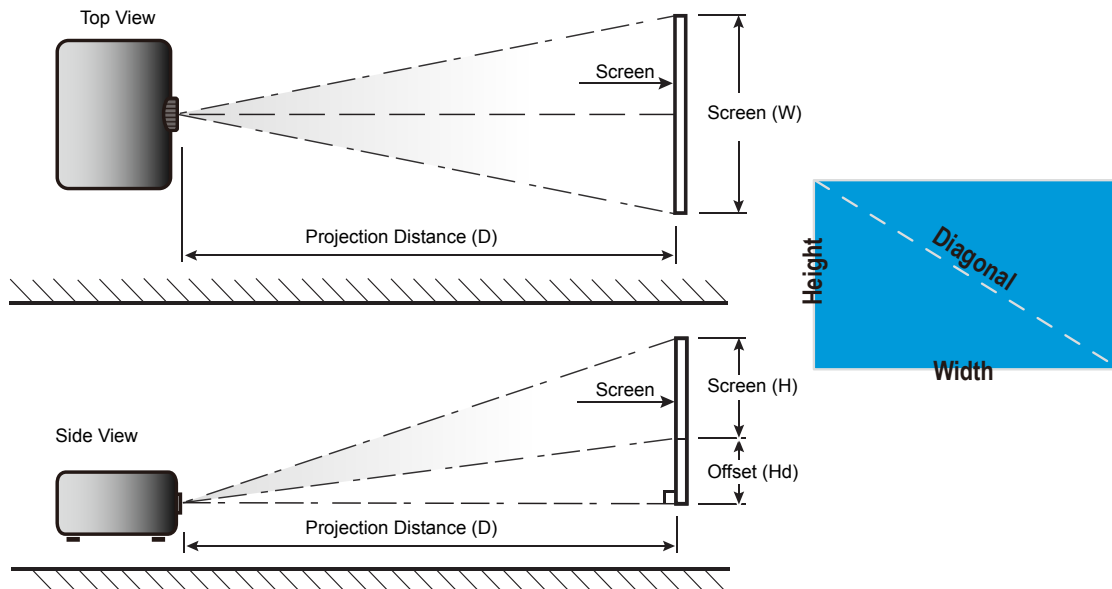

ADDITIONAL INFORMATION

Projector dimensions and ceiling mount installation

1. To prevent damage to your projector, please use the Optoma ceiling mount.
2. If you wish to use a third party ceiling mount kit, please ensure the screws used to attach a mount to the projector meet the following specifications:
 - Screw type: M4 for three point mounting
 - Minimum screw length: 10mm

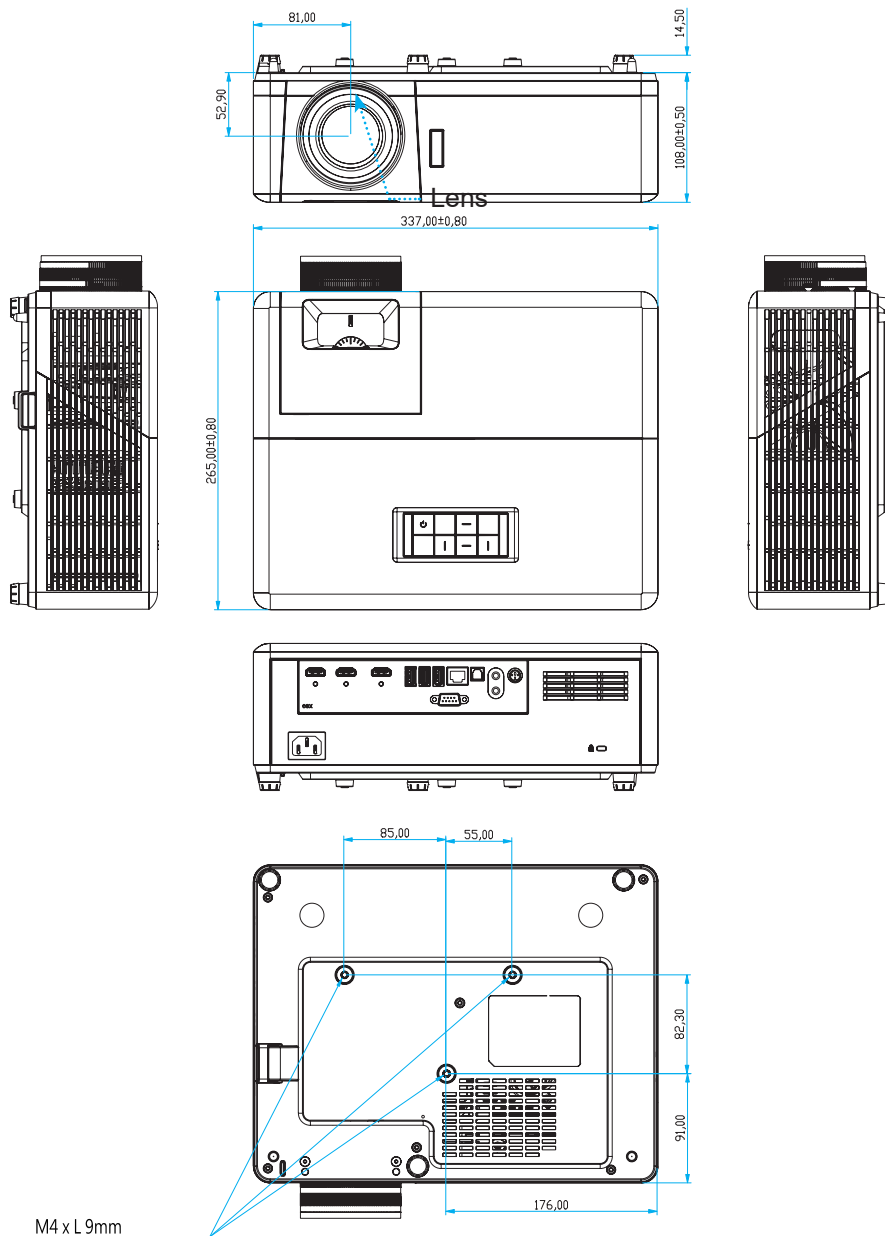

Unit: mm

Note: Please note that damage resulting from incorrect installation will void the warranty.



Warning:

- If you buy a ceiling mount from another company, please be sure to use the correct screw size. Screw size will vary depending on the thickness of the mounting plate.
- Be sure to keep at least 10 cm gap between the ceiling and the bottom of the projector.
- Avoid installing the projector near a heat source.

ADDITIONAL INFORMATION

IR remote codes



Key	Key num	MTX.	Format	Data0	Data1	Data2	Data3	Description	
Power on / off		K12	04	F1	32	CD	71	8E	Refer to the "Powering on / off the projector" on page 20.
Source		K3	11	F1	32	CD	18	E7	Press to select an input signal.
Home		K13	03	F1	32	CD	92	6D	Press to return to the Home screen.
Menu		K8	17	F1	32	CD	0E	F1	Press to launch the on-screen display (OSD) menu. To exit OSD, press again.
Return		K4	10	F1	32	CD	86	79	Press to return to the previous page.
Up		K7	18	F2	32	CD	11	EE	Use to select items or make adjustments to your selection.
Left		K14	02	F2	32	CD	10	EF	
Right		K5	09	F2	32	CD	12	ED	
Down		K2	19	F2	32	CD	14	EB	
Enter	Enter	K9	16	F1	32	CD	0F	F0	Confirm your item selection.
Mute		K15	01	F1	32	CD	52	AD	Press to turn off/on the projector built-in speaker.
Display Mode		K10	15	F1	32	CD	91	6E	Press to display the Display Mode menu. To exit the Display Mode menu, press again.
APP menu		K6	08	F1	32	CD	25	DA	Press to open the APP menu.
Volume -		K11	12	F2	32	CD	0C	F3	Press to decrease the volume.
Volume +		K1	05	F2	32	CD	09	F6	Press to increase the volume.

ADDITIONAL INFORMATION

Troubleshooting

If you experience a problem with your projector, please refer to the following information. If a problem persists, please contact your local reseller or service center.

Image problems

- ❓ *No image appears on-screen*
 - Ensure all the cables and power connections are correctly and securely connected as described in the "Installation" section.
 - Ensure the pins of connectors are not crooked or broken.
 - Ensure that the "Mute" feature is not turned on.

- ❓ *Image is out of focus*
 - Adjust the Focus Ring on the projector lens. Please see page 17.
 - Make sure the projection screen is between the required distance from the projector. (Please refer to page 65).

- ❓ *The image is stretched when displaying 16:9 DVD title*
 - When you play anamorphic DVD or 16:9 DVD, the projector will show the best image in 16: 9 format on projector side.
 - If you play 4:3 format DVD title, please change the format as 4:3 in projector OSD.
 - Please setup the display format as 16:9 (wide) aspect ratio type on your DVD player.

- ❓ *Image is too small or too large*
 - Adjust the zoom lever on the top of the projector.
 - Move the projector closer to or further from the screen.
 - Press "Menu" on the projector panel, go to "Display-->Aspect Ratio". Try the different settings.

- ❓ *Image has slanted sides:*
 - If possible, reposition the projector so that it is centered on the screen and below the bottom of the screen.

- ❓ *Image is reversed*
 - Select "Setup-->Projection" from the OSD and adjust the projection direction.

- ❓ *Blurry double image*
 - Make sure "Display Mode" is not 3D to avoid normal 2D image appear blurry double image.

ADDITIONAL INFORMATION

Other problems



The projector stops responding to all controls

- If possible, turn off the projector, then unplug the power cord and wait at least 20 seconds before reconnecting power.

Remote control problems



If the remote control does not work

- Check the operating angle of the remote control is pointed within $\pm 15^\circ$ (horizontally) or $\pm 10^\circ$ (vertically) to the IR receivers on the projector.
- Make sure there are not any obstructions between the remote control and the projector. Move to within 7 m (~22 ft) of the projector.
- Make sure batteries are inserted correctly.
- Replace batteries if they are exhausted.

Warning indicators

When the warning indicators (see below) light up or flash, the projector will automatically shutdown:

- "Light Source" LED indicator is lit red and if "On/Standby" indicator flashes red.
- "TEMP" LED indicator is lit red and if "On/Standby" indicator flashes red. This indicates the projector has overheated. Under normal conditions, the project can be switched back on.
- "TEMP" LED indicator flashes red and if "On/Standby" indicator flashes red.

Unplug the power cord from the projector, wait for 30 seconds and try again. If the warning indicator light up or flash, please contact your nearest service center for assistance.

ADDITIONAL INFORMATION

LED lightning messages

Message	On/Standby LED		Temp LED	Light Source LED
	(Red)	(Blue)	(Red)	(Red)
Standby state (Input power cord)	Steady light			
Power on (Warming)		Flashing (0.5 sec off / 0.5 sec on)		
Power on and light source lighting		Steady light		
Power off (Cooling)		Flashing (0.5 sec off / 0.5 sec on). Back to red steady light when cooling fan turns off.		
Error (Light source failure)	Flashing			Steady light
Error (Fan failure)	Flashing		Flashing	
Error (Over temp.)	Flashing		Steady light	
Standby State (Burn in mode)		Flashing		
Burn in (Warming)		Flashing		
Burn in (Cooling)		Flashing		
Burn in (Light source lighting)		Flashing (3 sec on / 1 sec off)		
Burn in (Light source off)		Flashing (1 sec on / 3 sec off)		

- Power off:

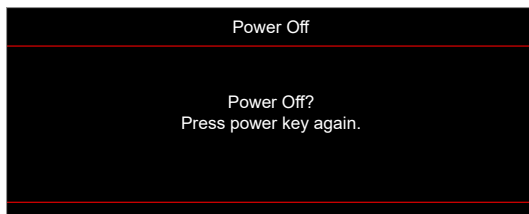

- Temperature warning:

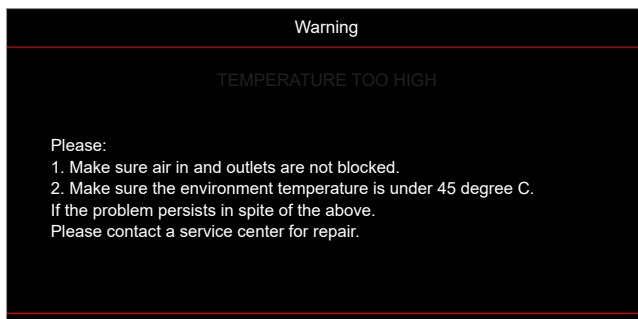

ADDITIONAL INFORMATION

- Fan failed:

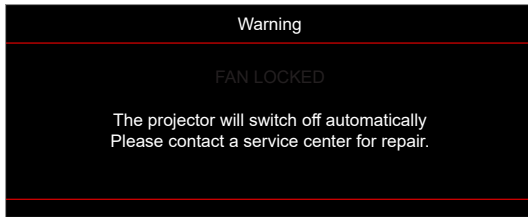

- Out of display range:

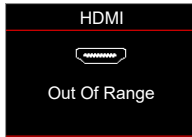

- Power down warning:

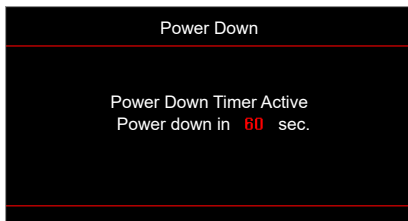

ADDITIONAL INFORMATION

Specifications

Optical	Description
Technology	Texas Instrument DMD, 0.47”(dimension)/ 4K UHD HSSI DMD X1, S451 (Packing typing), with 4-Way XPR actuator
Output resolution	4K UHD 3840 x 2160 @ 60Hz
Maximum input resolution	4096 x 2160 @ 60Hz
Lens	<ul style="list-style-type: none">• Throw ratio: 1.21~1.59• F-stop: 1.94~2.23• Focal length: 12.81~16.74mm• Zoom range: 1.3x
Offset	105%~115%, vertical only
Image size	34.1”~302.4”, optimized wide 82”
Projection distance	1.2m ~ 8.1m
I/Os	<ul style="list-style-type: none">• HDMI V2.0 / HDCP2.2 (x3)• USB2.0 (For FW upgrade) USB-A for 5V PWR 1.5A• Audio Out 3.5mm• USB2.0 USB-A for USB disk driver and WiFi dongle (x3)• RS-232 male (9-pin D-SUB)• RJ-45 (Support IoT, Internet, and OTA functions)• S/PDIF (Supports PCM 2-channel, Dolby Digital (5.1))• 12V Trigger (3.5mm jack)• 3D Sync
Colour	1073.4 Million color
Scan rate	<ul style="list-style-type: none">• Horizontal scan rate: 31.0~135.0 KHz• Vertical scan rate: 24~120 Hz
Speaker	Yes, 8W
Power consumption	<ul style="list-style-type: none">• Brightness Mode: 100%<ul style="list-style-type: none">• 240W (typical) ±15% @ 110VAC• 230W (typical) ±15% @ 220VAC• Eco Mode: 80%<ul style="list-style-type: none">• 185W (typical) ±15% @ 110VAC• 175W (typical) ±15% @ 220VAC
Power requirement	100 - 240V ±10%, AC 50/60Hz
Input current	3.5A
Installation orientations	Front, Rear, Ceiling-top, Rear-top
Dimensions (W x D x H)	<ul style="list-style-type: none">• Without feet: 337 x 265 x 108 mm (13.26 x 10.43 x 4.25 inches)• With feet: 337 x 265 x 119.3 mm (13.26 x 10.43 x 4.69 inches)
Weight	< 5.0 kg (<11.02 lbs)
Environmental	Operating in 0~40°C , 80% humidity (non-condensing)

Note: All specifications are subject to change without notice.



ADDITIONAL INFORMATION

Optoma global offices

For service or support, please contact your local office.



USA

47697 Westinghouse Drive,
Fremont, CA 94539, USA
www.optomausa.com

 888-289-6786
 510-897-8601
 services@optoma.com



Canada

47697 Westinghouse Drive,
Fremont, CA 94539, USA
www.optomausa.com

 888-289-6786
 510-897-8601
 services@optoma.com



Latin America

47697 Westinghouse Drive,
Fremont, CA 94539, USA
www.optomausa.com

 888-289-6786
 510-897-8601
 services@optoma.com



Europe

Unit 1, Network 41, Bourne End Mills,
Hemel Hempstead, Herts,
HP1 2UJ, United Kingdom
www.optoma.eu
Service Tel : +44 (0)1923 691865

 +44 (0) 1923 691 800
 +44 (0) 1923 691 888
 service@tsc-europe.com



Benelux BV

Randstad 22-123
1316 BW Almere
The Netherlands
www.optoma.nl

 +31 (0) 36 820 0252
 +31 (0) 36 548 9052



France

Bâtiment E
81-83 avenue Edouard Vaillant
92100 Boulogne Billancourt, France

 +33 1 41 46 12 20
 +33 1 41 46 94 35
 savoptoma@optoma.fr



Spain

C/ José Hierro,36 Of. 1C
28522 Rivas VaciaMadrid,
Spain

 +34 91 499 06 06
 +34 91 670 08 32



Deutschland

Am Nordpark 3
41069 Mönchengladbach
Germany

 +49 (0) 2161 68643 0
 +49 (0) 2161 68643 99
 info@optoma.de

Scandinavia



Lerpeveien 25
3040 Drammen
Norway

 +47 32 98 89 90
 +47 32 98 89 99
 info@optoma.no

PO.BOX 9515
3038 Drammen
Norway

Korea

WOOMI TECH.CO.,LTD.
4F, Minu Bldg.33-14, Kangnam-Ku,
Seoul,135-815, KOREA
korea.optoma.com

 +82+2+34430004
 +82+2+34430005

Japan

東京都足立区綾瀬3-25-18
株式会社オーエス
コンタクトセンター:0120-380-495

 info@os-worldwide.com
www.os-worldwide.com



Taiwan

12F., No.213, Sec. 3, Beixin Rd.,
Xindian Dist., New Taipei City 231,
Taiwan, R.O.C.
www.optoma.com.tw

 +886-2-8911-8600
 +886-2-8911-6550
 services@optoma.com.tw
asia.optoma.com



Hong Kong

Unit A, 27/F Dragon Centre,
79 Wing Hong Street,
Cheung Sha Wan,
Kowloon, Hong Kong

 +852-2396-8968
 +852-2370-1222
www.optoma.com.hk

China

5F, No. 1205, Kaixuan Rd.,
Changning District
Shanghai, 200052, China

 +86-21-62947376
 +86-21-62947375
www.optoma.com.cn

