

USER MANUAL

MODEL:

VP-427X1

4K HDBT/HDMI Receiver/Scaler

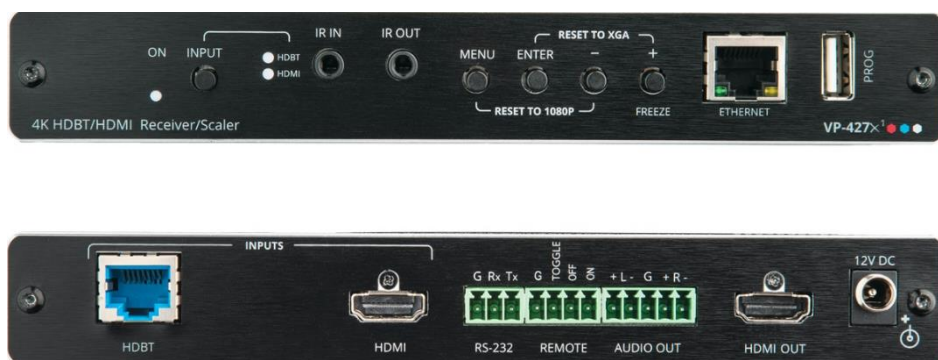

Contents

Introduction	1
Getting Started	1
Overview	2
Typical Applications	3
Defining VP-427X1 4K HDBT/HDMI Receiver/Scaler	4
Mounting VP-427X1	6
Connecting VP-427X1	7
Connecting the Output to a Balanced/Unbalanced Stereo Audio Acceptor	8
Connecting to VP-427X1 via RS-232	8
Wiring RJ-45 Connectors	8
Operating and Controlling VP-427X1	9
Using Front Panel Buttons	9
Connecting the Remote Control Switches	9
Using the OSD Menu	10
Operating via Ethernet	18
Using Embedded Web Pages	21
Loading and Saving Configurations	23
Entering Standby Mode	23
Configuring Video Input Settings	24
Selecting an Input	25
Freezing or Blanking the Video Output Signal	25
Adjusting the Output Volume	25
Viewing Device Details	26
Upgrading the Firmware	27
Configuring Network Settings	28
Performing Device Soft Factory Reset	29
Configuring Video Output Settings	29
Configuring HDCP per Input/Output	30
Managing EDID	31
Adjusting the Audio Delay and Volume	33
Configuring Automatic Switching Settings	34
Defining CEC Functionality	35
Controlling VP-427X1 via the RS-232 Terminal Block Connectors	36
Managing Authentication	44
Viewing About Page	46
Upgrading Firmware	47
USB Firmware Upgrade (USB Format FAT32)	47
Technical Specifications	48
Default Communication Parameters	49
Default EDID	49
Protocol 3000	53
Understanding Protocol 3000	53
Protocol 3000 Commands	54
Result and Error Codes	62

Introduction

Welcome to Kramer Electronics! Since 1981, Kramer Electronics has been providing a world of unique, creative, and affordable solutions to the vast range of problems that confront the video, audio, presentation, and broadcasting professional on a daily basis. In recent years, we have redesigned and upgraded most of our line, making the best even better!

Getting Started

We recommend that you:

- Unpack the equipment carefully and save the original box and packaging materials for possible future shipment.
- Review the contents of this user manual.



Go to www.kramerav.com/downloads/VP-427X1 to check for up-to-date user manuals, application programs, and to check if firmware upgrades are available (where appropriate).

Achieving Best Performance

- Use only good quality connection cables (we recommend Kramer high-performance, high-resolution cables) to avoid interference, deterioration in signal quality due to poor matching, and elevated noise levels (often associated with low quality cables).
- Do not secure the cables in tight bundles or roll the slack into tight coils.
- Avoid interference from neighboring electrical appliances that may adversely influence signal quality.
- Position your Kramer **VP-427X1** away from moisture, excessive sunlight and dust.

Safety Instructions



Caution:

- This equipment is to be used only inside a building. It may only be connected to other equipment that is installed inside a building.
- For products with relay terminals and GPIO ports, please refer to the permitted rating for an external connection, located next to the terminal or in the User Manual.
- There are no operator serviceable parts inside the unit.



Warning:

- Use only the power cord that is supplied with the unit.
- To ensure continuous risk protection, replace fuses only according to the rating specified on the product label which is located on the bottom of the unit.

Recycling Kramer Products

The Waste Electrical and Electronic Equipment (WEEE) Directive 2002/96/EC aims to reduce the amount of WEEE sent for disposal to landfill or incineration by requiring it to be collected

and recycled. To comply with the WEEE Directive, Kramer Electronics has made arrangements with the European Advanced Recycling Network (EARN) and will cover any costs of treatment, recycling and recovery of waste Kramer Electronics branded equipment on arrival at the EARN facility. For details of Kramer's recycling arrangements in your particular country go to our recycling pages at www.kramerav.com/il/quality/environment.

Overview

Congratulations on purchasing your Kramer **VP-427X1 4K HDBT/HDMI Receiver/Scaler**.

VP-427X1 is a high-performance auto-switcher/scaler receiver with an HDBaseT input and a local HDMI™ input for 4K HDMI™ over extended-reach HDBaseT and can be powered via Ethernet (PoE, PD). It supports automatic and manual glitch-free switching between the 2 inputs, and up- or down-scaling to any resolution up to 4K@60Hz (4:4:4). The output scaling automatically matches the resolution of the HDMI display on the output, or it can be manually set by the user. **VP-427X1** enables extending video signals up to 180m over CAT copper cables at up to 4K@60Hz (4:2:0) 24bpp video resolution and provides even further reach for lower HD video resolutions.

VP-427X1 provides exceptional quality, advanced and user-friendly operation, and flexible connectivity and control.

Exceptional Quality

- Comprehensive Receiver/Scaler – Scales signals of all standard resolutions, to any resolution, up to 4K@60Hz (4:4:4) for routing to the HDMI output. Constant output sync prevents signal disruption when switching between inputs and when no video is detected.
- Audio De-embedding – Analog balanced stereo output for de-embedding the audio to speakers.
- Data Tunneling – Extend RS-232, IR, and Ethernet over the HDBaseT line.
- Built-in Automated Control – Includes relay outputs and easy connection to occupancy sensors and contact closure switches.
- CEC Support – Supports passing of CEC from input to output. Automatically sends CEC commands to shut down the output display after a timeout period when no input signal is found, and to power up the display when the input returns.
- Output resolutions –up to 4K@60Hz (4:4:4).
- HDMI Signal Extension – HDCP 1.4 / 2.2.
- HDMI Support – 4K60, CEC, xvYCC color (on input), as specified in HDMI 2.0.

Advanced and User-friendly Operation

- Multiple aspect ratio selections.
- Auto-switching and auto-scanning of inputs.
- Built-in video Proc-Amp – color, hue, sharpness, contrast, and brightness are set individually for each input.

- Efficient power-saving features.
- An OSD (On-Screen Display) – for making adjustments.
- Firmware Upgrade options– directly via memory stick or Ethernet-based, via a user-friendly software upgrade tool.
- Advanced EDID management per input.
- Easy, Cost-effective Maintenance – Local firmware upgrade via USB.
- Easy and Elegant Installation – Single cable connectivity for both HDBaseT signals and power. Compact MegaTOOLS™ fan-less enclosure for dropped-ceiling mounting, or side-by-side mounting of 2 units in a 1U rack space with the recommended rack adapter.

Flexible Connectivity and Control

- 2 HDBT and 1 HDMI inputs.
- 1 scaled HDMI video output.
- Embedded audio on the HDMI.
- One analog balanced stereo audio output.
- Built-in relay connections
- Powered via Ethernet (PoE, PD).
- Cost-Effective and Convenient Control Options – Ethernet and RS-232 serial ports, and local control via front panel input selection and OSD menu buttons.
- ProcAmp Control – Contrast, brightness, color, etc.
- Convenient Unit Control and Configuration Options – Local control via front panel source switching buttons and OSD menu. Distance control via RS-232 serial commands transmitted by a PC, touch screen system or other serial controller and relay switches.

Typical Applications

VP-427X1 is ideal for the following typical applications:

- Classrooms and meeting rooms with multiple connections that require automated switching and automated display control
- Projection systems in conference rooms, boardrooms, auditoriums, and churches.
- Any application where high quality conversion and switching of multiple and different video signals to graphical data signals is required for display or projection purposes.

Controlling your VP-427X1

Control your VP-427X1 directly via the front panel push buttons (with on-screen menus, or:

- By RS-232 serial commands transmitted by a touch screen system, PC, or other serial controller.
- Via the Ethernet using built-in user-friendly web pages.

Defining VP-427X1 4K HDBT/HDMI Receiver/Scaler

This section defines VP-427X1.

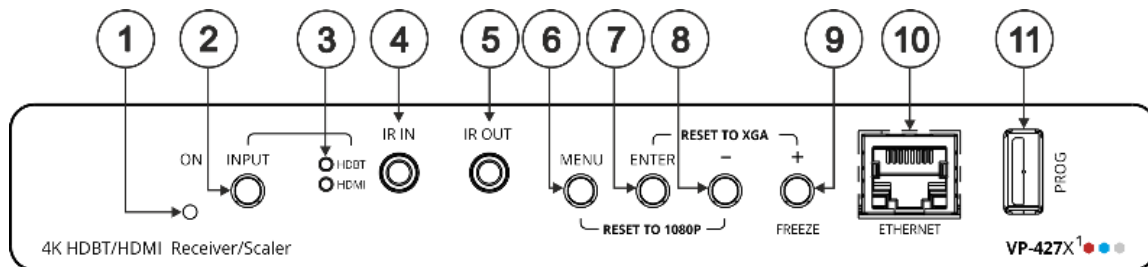



Figure 1: VP-427X1 4K HDBT/HDMI Receiver/Scaler Front Panel

#	Feature	Function	
①	ON LED	Lights green when device is powered.	
②	INPUT Select Button	Press to select the input (HDBT or HDMI).	
③	Input LEDs	HDBT	Lights green when the HDBT input is selected.
		HDMI	Lights green when the HDMI input is selected.
		If the selected source is not connected to an input, its LED flashes.	
④	3.5mm Mini Jack	Connect to an IR sensor. Use to control a remote device that is connected to the transmitter side. IR commands are passed via HDBT tunneling to the selected HDBT input (1 or 2).	
⑤	IR OUT 3.5mm Mini Jack	Connect to an external IR emitter to control a local device from the transmitter side.	
⑥	MENU Button	Press to enter/exit the on-screen display (OSD) menu. Press together with the – button to reset the output to 1080p resolution.	
⑦	ENTER Button	In OSD, press to choose the highlighted menu item. Press together with the FREEZE/+ button to reset the output to XGA resolution (1024x768).	
⑧	– Button	In OSD, press to move back through menus or decrement parameter values. Press together with the MENU button to reset the output to 1080p resolution.	
⑨	FREEZE/+ Button	In OSD, press to move forward through menus or increment parameter values. When not in OSD, press to freeze the display.	
⑩	ETHERNET RJ-45 Connector	Connect to a PC via a LAN to setup and monitor the VP-427X1, tunnel data via HDBT, as well as upgrade the firmware. (Configured via web pages). Can provide power to the unit.	
⑪	PROG USB Connector	Connect to a USB stick to perform firmware upgrades.	

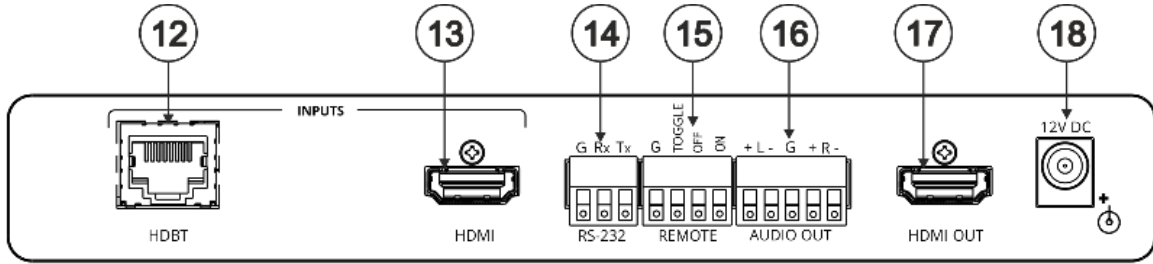

Figure 2: VP-427X1 4K HDBT/HDMI Receiver/Scaler Front Panel

#	Feature	Function
12	INPUTS	HDBT RJ-45 Connector
13		HDMI Connector
14	RS-232 CONTROL 3-pin Terminal Block Connector	Connect to a serial controller or PC to control VP-427X1 (default configuration), connect to a device (e.g., a display) to control it via VP-427X1, or use for RS-232 tunneling via HDBT. Configurable via the device web page.
15	REMOTE Contact-Closure 4-pin Terminal Block Connector	Connect to contact closure switches, an occupancy sensor and/or toggle switches (contact between the desired pin and GND pin), to turn the display on or off (see Connecting the Remote Control Switches on page 9).
16	AUDIO 5-pin Terminal Block Connector	Connect to a balanced stereo audio acceptor.
17	HDMI OUT Connector	Connect to an HDMI acceptor.
18	12V DC Connector	Connect to the supplied power adapter.

Mounting VP-427X1

This section provides instructions for mounting **VP-427X1**. Before installing, verify that the environment is within the recommended range:



- Operation temperature – 0° to 40°C (32 to 104°F).
- Storage temperature – -40° to +70°C (-40 to +158°F).
- Humidity – 10% to 90%, RHL non-condensing.



Caution:

- Mount **VP-427X1** before connecting any cables or power.



Warning:

- Ensure that the environment (e.g., maximum ambient temperature & air flow) is compatible for the device.
- Avoid uneven mechanical loading.
- Appropriate consideration of equipment nameplate ratings should be used for avoiding overloading of the circuits.
- Reliable earthing of rack-mounted equipment should be maintained.
- Maximum mounting height for the device is 2 meters.

Mount VP-427X1 in a rack:

- Use the recommended rack adapter
(see www.kramerav.com/product/VP-427X1).

Mount VP-427X1 on a surface using one of the following methods:

- Attach the rubber feet and place the unit on a flat surface.
- Fasten 2 brackets (included) on each side of the unit and attach them to a flat surface. For more information go to www.kramerav.com/downloads/VP-427X1.

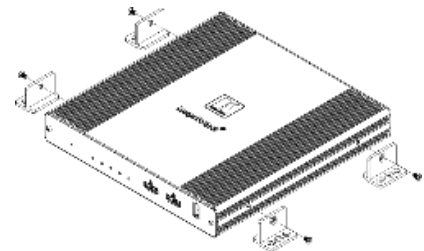

Connecting VP-427X1



Always switch off the power to each device before connecting it to your **VP-427X1**. After connecting your **VP-427X1**, connect its power and then switch on the power to each device.

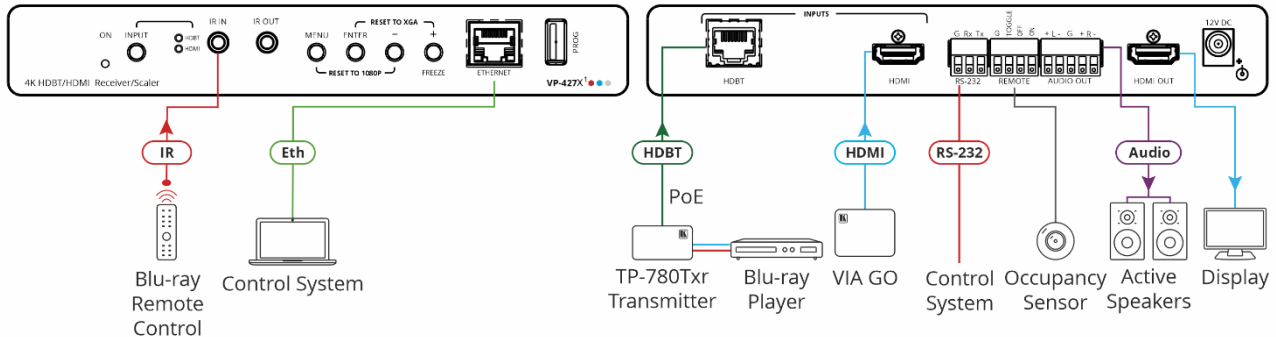

Figure 3: Connecting to the VP-427X1

To connect VP-427X1 as illustrated in the example in [Figure 3](#):

1. Connect an HDBT transmitter (for example, Kramer **TP-780Txr**) to the INPUT HDBT RJ-45 port (12) on the front panel. The transmitter is connected to a Blu-ray player.
2. Connect an HDMI source (for example, Kramer **VIA GO**) to the HDMI INPUT connector (13).
3. Connect the HDMI OUT connector (17) to an HDMI Acceptor (for example, a display).
4. Connect the REMOTE pins (15) to contact closure switches (for example, an occupancy sensor). (See [Connecting the Remote Control Switches](#) on page 9).
5. Connect the AUDIO OUT 5-pin terminal block connector (16) to a balanced stereo audio acceptor (for example, Kramer **Tavor 5-O** active speakers).
6. Connect an IR sensor to the IR IN 3.5mm mini jack (4). In this example, point the Blu-ray remote controller to the sensor to control the Blu-ray that is connected to **TP-780Txr** via HDBT.
7. Connect a control system (for example, a laptop) to the ETHERNET RJ-45 port (10).
8. Connect a control system to the RS-232 3-pin terminal block connector (15). (See [Connecting to VP-427X1 via RS-232](#) on page 8).
9. If there is no PoE input, connect the power adaptor to the **VP-427X1** and plug the adaptor to the mains electricity (not shown in [Figure 3](#)).

Connecting the Output to a Balanced/Unbalanced Stereo Audio Acceptor

The following are the pinouts for connecting the output to a balanced or unbalanced stereo audio acceptor:

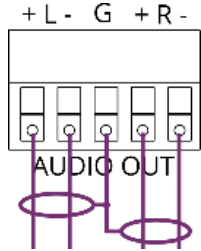

Figure 4: Connecting to a Balanced Stereo Audio Acceptor

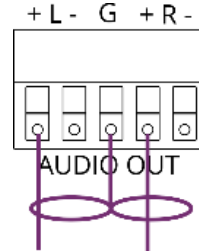

Figure 5: Connecting to an Unbalanced Stereo Audio Acceptor

Connecting to VP-427X1 via RS-232

You can connect to VP-427X1 via an RS-232 connection (15) using, for example, a PC.

VP-427X1 features an RS-232 3-pin terminal block connector allowing RS-232 control of VP-427X1.

Connect the RS-232 terminal block on the rear panel of VP-427X1 to a PC/controller, as follows:

From the RS-232 9-pin D-sub serial port connect:

- Pin 2 to the TX pin on the VP-427X1 RS-232 terminal block
- Pin 3 to the RX pin on the VP-427X1 RS-232 terminal block
- Pin 5 to the G pin on the VP-427X1 RS-232 terminal block

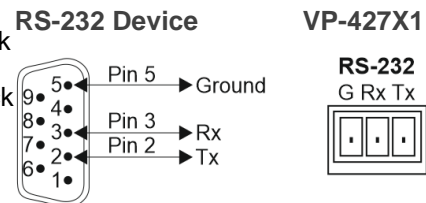

Wiring RJ-45 Connectors

This section defines the HDBT pinout, using a straight pin-to-pin cable with RJ-45 connectors.

i For HDBT cables, it is recommended that the cable ground shielding be connected/soldered to the connector shield.

EIA /TIA 568B	
PIN	Wire Color
1	Orange / White
2	Orange
3	Green / White
4	Blue
5	Blue / White
6	Green
7	Brown / White
8	Brown

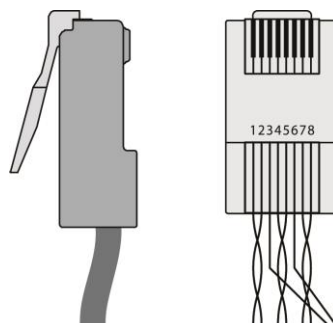

Operating and Controlling VP-427X1

Operate and control VP-427X1 by:

- [Using Front Panel Buttons](#) on page [9](#).
- [Connecting the Remote Control Switches](#) on page [9](#).
- [Using the OSD Menu](#) on page [10](#).
- [Operating via Ethernet](#) on page [18](#).

Using Front Panel Buttons

Use VP-427X1 front panel buttons enable performing the following actions:

- Pressing the **INPUT** (2) to and cycling through the inputs to select an input.
- Using the MENU, ENTER (when in the OSD menu), + and – buttons to control the device (see [Using the OSD Menu](#) on page [10](#)).
- Pressing **MENU** (6) and - (8) to reset the resolution to 1080p.
- Pressing **ENTER** (7) and + (9) to reset the resolution to XGA.
- Pressing **FREEZE** (9) to freeze the image.

Connecting the Remote Control Switches

Control the display status via remote control switches.

Pin Name	Function
TOGGLE	Toggle the display on / off (via CEC): A single button toggles between display on and display off. Alternatively, using the VP-427X1 OSD, configure turning the display on or off according to whether the switch is open or closed, for example, when using an occupancy sensor. (See Configuring TOGGLE Pin Behavior on page 17 and/or Defining the TOGGLE Pin Behavior on page 35).
OFF	Turn off the display (via CEC).
ON	Turn on the display (via CEC).

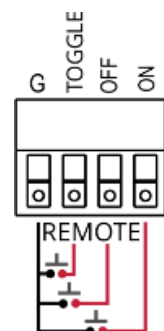

Using the OSD Menu

VP-427X1 enables controlling and defining the device parameters via the OSD, using the front panel MENU buttons.

To enter and use the OSD menu buttons:

1. Press MENU.
2. Press:
 - **ENTER** to accept changes and to change the menu settings.
 - **Arrow buttons** to move through the OSD menu, which is displayed on the video output.
 - **EXIT** to exit the menu.



The default OSD timeout is set to 10 seconds.

Use the OSD menu to perform the following operations:

- [Adjusting Image Parameters](#) on page [11](#).
- [Selecting an Input Signal](#) on page [11](#).
- [Setting Output Parameters](#) on page [12](#).
- [Setting Audio Parameters](#) on page [12](#).
- [Setting OSD Parameters](#) on page [13](#).
- [Managing EDID via OSD](#) on page [13](#).
- [Setting HDCP](#) on page [14](#).
- [Setting Sleep Mode](#) on page [15](#).
- [Setting Switching Mode](#) on page [15](#).
- [Defining FREEZE Button Operation Mode](#) on page [16](#).
- [Setting Ethernet Parameters](#) on page [16](#).
- [Defining CEC](#) on page [17](#).
- [Configuring TOGGLE Pin Behavior](#) on page [17](#).
- [Defining HDBT Range](#) on page [17](#).
- [Viewing Device Information](#) on page [18](#).
- [Performing a Reset](#) on page [18](#).

Adjusting Image Parameters

VP-427X1 enables adjusting the image parameters such as contrast, brightness and so on.

To adjust the image parameters:

1. On the front panel press **MENU**. The menu appears.
2. Click **Picture** and define the image parameters according to the information in the following table:

Menu Item	Function	
Contrast	Set the contrast.	
Brightness	Set the brightness.	
Finetune	Video	HUE – Set the color hue.
		SATURATION – Set the color saturation.
		SHARPNESS – Set the sharpness of the picture.
		NOISE REDUCTION – Select the noise reduction filter: Off (default), Low, Middle or High.
Color	Set the Red, Green and Blue shades.	

Image parameters are adjusted.

Selecting an Input Signal

Select the VP-427X1 input source via the OSD menu.

To set the input source:

1. On the front panel press **MENU**. The menu appears.
2. Click **Input** and select the **Source**: HDBT (default) or HDMI.

An input signal is selected.

Setting Output Parameters

VP-427X1 enables setting output parameters such as the size of the image and output resolution via the OSD MENU buttons.

To set the output parameters:

1. On the front panel press **MENU**. The menu appears.
2. Click **Output** and define the output parameters according to the information in the following table:

Menu Item	Function			
Size	Set the size of the image: Best Fit (default), Full, Over Scan, Follow In, Under 1, Under 2, Letter Box, Pan Scan.			
Resolution	Select the output resolution (default, Native):			
	1024x768 @60Hz	1920x1080P @30Hz	720x480P @60Hz	1440x900 @60Hz
	800x600 @60Hz	1920x1080P @25Hz	2560x1600 @60Hz RB	1400x1050 @60Hz
	640x480 @60Hz	1920x1080P @24Hz	1280x720 @60Hz	1360x768 @60Hz
	3840x2160P @60Hz	1920x1080P @50Hz	1920x1080 @60Hz	1280x1024 @60Hz
	3840x2160P @50Hz	1280x720P @50Hz	2560x1600 @60Hz RB	1280x800 @60Hz
	3840x2160P @30Hz	720x576P @50Hz	1920x1200 @60Hz RB	1280x768 @60Hz
	3840x2160P @25Hz	1920x1080P @60Hz	1680x1050 @60Hz	
	3840x2160P @24Hz	1280x720P @60Hz	1600x1200 @60Hz	

Image size and output resolution are defined.

Setting Audio Parameters

VP-427X1 enables defining the audio delay time and output volume.

To set the audio:

1. On the front panel press **MENU**. The menu appears.
2. Click **Audio** and define the following:
 - Set the audio delay time (lip sync) to off, 40ms (default), 110ms or 150ms.
 - Set the AUDIO OUT output volume (default is 80 = 0dB).

Audio parameters are defined.

Setting OSD Parameters

VP-427X1 enables adjusting OSD parameters for your convenience via the OSD MENU buttons.

To set the OSD parameters:

1. On the front panel press **MENU**. The menu appears.
2. Click **OSD** and define the OSD parameters according to the information in the following table:

Menu Item	Function
H-Position	Set the horizontal position of the OSD.
V-Position	Set the vertical position of the OSD.
Timer	Set the timeout period to Off or up to 60 seconds (default 10).
Transparency	Set the OSD background between 100 (transparent) and 0 (opaque).
Display	Select the information displayed on-screen during operation: Info (default) – the information appears for 10 seconds. On – the information appears constantly. Off – the information does not appear.

OSD parameters are set.

Managing EDID via OSD

VP-427X1 enables managing the EDID via the OSD MENU buttons.

Uploading the EDID

To upload EDID:

1. On the front panel press **MENU**. The menu appears.
2. Click **EDID Manage** and select the parameters according to the information in the following table:

Menu Item	Function
EDID on HDBT	Select one of the following EDID sources and then press enter: <ul style="list-style-type: none"> • A built-in EDID file: Def. 1080P, Def.1080P (AUD), Def. 4K (3G), Def. 4K (3G - AUD). • The HDMI Output. • An external file (see Uploading EDID from an External File on page 14).
EDID on HDMI	Select one of the EDID sources and then press enter: <ul style="list-style-type: none"> • A built-in EDID file: Def. 1080P, Def.1080P (AUD), Def. 4K (3G), Def. 4K (3G - AUD), Def. 4K (6G), Def. 4K (6G - AUD) • The HDMI Output. • An external file (see Uploading EDID from an External File on page 14).

The selected EDID is sent to the input.

Uploading EDID from an External File

To select the EDID from an external file:

1. Save an EDID file via the EDID webpage (see [Managing EDID](#) on page 31).
2. On the front panel press **MENU**. The OSD menu appears.
3. Click **Advanced** and select **EDID Manage**.
4. Select an HDMI input and then select **File**.
The external EDID file (as stored via the EDID embedded page) is stored.

An external EDID file is sent to a selected input.

Setting HDCP

VP-427X1 enables setting the HDCP on the inputs and on the output via the front panel **MENU** buttons.

To set the HDCP on the inputs and output:

1. On the front panel press **MENU**. The menu appears.
2. Click **Advanced** and define the HDCP parameters according to the information in the following table:

Menu Item	Function
HDCP On Input	Set HDCP support on HDBT and HDMI inputs to ON (default) or OFF. Note that: <ol style="list-style-type: none"> 1. HDCP must be enabled (ON) to support HDCP encrypted sources. 2. Sources such as Mac computers encrypt their outputs when detecting that the sink supports HDCP. If the content does not require HDCP, you can prevent these sources from encrypting by disabling (OFF) HDCP on the input.
HDCP On Output	Select FOLLOW OUTPUT (default) or FOLLOW INPUT on the HDMI OUT. Select FOLLOW OUTPUT (recommended) for the scaler to match its HDCP output to the HDCP setting of the acceptor to which it is connected. Select FOLLOW INPUT to change its HDCP output setting according to the HDCP of the input (recommended when the output is connected to a splitter/switcher).

HDCP is set on the input/output.

Setting Sleep Mode

Auto Sync Off turns off the output after a period of not detecting a valid video signal on the input(s) until a valid input is again detected or any keypad button is pressed.

VP-427X1 enables configuring the Auto Sync Off delay time when a connected display enters sleep mode.

To set Auto Sync Off:

1. On the front panel press **MENU**. The menu appears.
2. Click **Advanced** and select **Auto Sync Off**.
3. Define Auto Sync Off according to the information in the following table:

Menu Item	Function
Off (default)	Leave outputs active always.
Fast	Disable outputs after ~ 10 seconds of no input detection.
Slow	Disable outputs after ~ 2 minutes of no input detection.
Immediate	Disable outputs immediately.

Sleep mode is defined.

Setting Switching Mode

VP-427X1 enables configuring for automatic switching of the input source upon signal loss or when a source is plugged in.

To set the switching mode:

1. On the front panel press **MENU**. The menu appears.
2. Click **Advanced** and select **Auto Switching**.
3. Select the switching mode according to the information in the following table:

Menu Item	Function
Off	For manual switching.
Auto Scan	Scans for a valid input when no signal is found on the selected input.
Last Connected	Automatically switches to the last connected input and reverts to the previously selected input after that input is lost.

Switching mode is defined.

Defining FREEZE Button Operation Mode

VP-427X1 enables defining the function of the FREEZE front panel button (8).

To define the FREEZE button operation mode:

1. On the front panel press **MENU**. The menu appears.
2. Click **Advanced** and select **Freeze**.
3. Set freeze mode according to the information in the following table:

Menu Item	Function
Freeze + Mute	Freeze the image and mute the audio output.
Only Mute	Mute the audio output.
Only Freeze	Freeze the image.

When pressed, FREEZE button functions as defined.

Setting Ethernet Parameters

VP-427X1 enables defining the Ethernet parameters via the MENU front panel buttons.

To set the Ethernet parameters:

1. On the front panel press **MENU**. The menu appears.
2. Click **Advanced** and define the Ethernet parameters according to the information in the following table:

Menu Item	Function
IP Mode	Select Static IP (default) or DHCP.
Static IP Address	Enter to change the IP address.
Subnet Mask	Enter to change the subnet mask.
Default Gateway	Enter to change the default gateway.
TCP Port	Enter TCP port # (5000, by default).
UDP Port	Enter UDP port # (50000, by default).
IP	View the current IP address.
MAC ADDRESS	View the MAC address.

Network parameters are defined.

Defining CEC

VP-427X1 can be configured to automatically send CEC on/off commands to the connected display (default) or to pass CEC commands from the connected source to the connected display.

To set the CEC (Consumer Electronic Control) functionality:

1. On the front panel press **MENU**. The menu appears.
2. Click **Advanced** and select **Output CEC Bypass**.
3. Select:
 - **Off** – Automatically send CEC commands to shut down the output display after a timeout period when no input signal is found and to power up the display when the input returns.
 - **On** – Pass CEC commands from the source to the display.

CEC functionality is defined.

Configuring TOGGLE Pin Behavior

VP-427X1 enables defining the function of the REMOTE pin (13) on the rear panel.

To configure the TOGGLE pin (see [Connecting the Remote Control Switches](#) on page 9):

1. On the front panel press **MENU**. The menu appears.
2. Click **Advanced** and select **Toggle Pin**.
3. Select the TOGGLE pin configuration:
 - Edge = (toggle on/off).
 - Input Select.
 - GND=Off / Hi=On
 - GND=On / Hi=Off
 - Hi=Off

Defining HDBT Range

VP-427X1 enables defining the HDBT port range.

To define HDBT extra range:

1. On the front panel press **MENU**. The menu appears.
2. Click **Advanced** and select **HDBT Extra Range**.
3. Select:
 - **Off** – 1080p signal extends to 130m.
 - **On** – extra range, 1080p signal extends to 180m.

HDBT range is defined.

Viewing Device Information

Device information includes the selected source, the input and output resolutions, and the software version.

To view the information:

1. On the front panel press **MENU**. The menu appears.
2. Click **INFO** and view the input resolution, output resolution and software version.

Information is displayed.

Performing a Reset

VP-427X1 enables performing either a soft reset or a full reset via the front panel **MENU** buttons.

To reset the device:

1. On the front panel press **MENU**. The menu appears.
2. Click **Factory** and select either Reset (full reset) or a Soft Reset (reset device information excluding Ethernet parameters), then click **Yes**.
Wait for completion of factory reset (resolution is set to Native).

Device is reset.

Operating via Ethernet

You can connect to **VP-427X1** via Ethernet using either of the following methods:

- Directly to the PC using a crossover cable (see [Connecting Ethernet Port Directly to a PC](#) on page 18).
- Via a network hub, switch, or router, using a straight-through cable (see [Connecting Ethernet Port via a Network Hub](#) on page 20).

Note: If you want to connect via a router and your IT system is based on IPv6, speak to your IT department for specific installation instructions.

Connecting Ethernet Port Directly to a PC

You can connect the Ethernet port of **VP-427X1** directly to the Ethernet port on your PC using a crossover cable with RJ-45 connectors.



This type of connection is recommended for identifying **VP-427X1** with the factory configured default IP address.

After connecting **VP-427X1** to the Ethernet port, configure your PC as follows:

1. Click **Start > Control Panel > Network and Sharing Center**.
2. Click **Change Adapter Settings**.

- Highlight the network adapter you want to use to connect to the device and click **Change settings of this connection**.

The Local Area Connection Properties window for the selected network adapter appears as shown in [Figure 6](#).

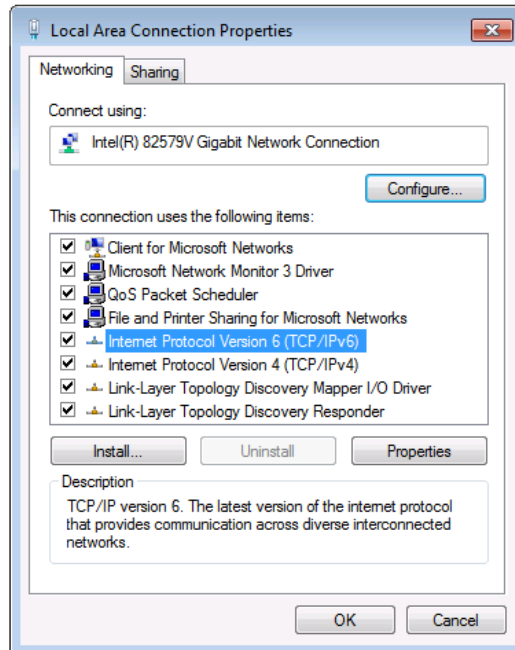

Figure 6: Local Area Connection Properties Window

- Highlight either **Internet Protocol Version 6 (TCP/IPv6)** or **Internet Protocol Version 4 (TCP/IPv4)** depending on the requirements of your IT system.
- Click **Properties**.

The Internet Protocol Properties window relevant to your IT system appears as shown in [Figure 7](#) or [Figure 8](#).

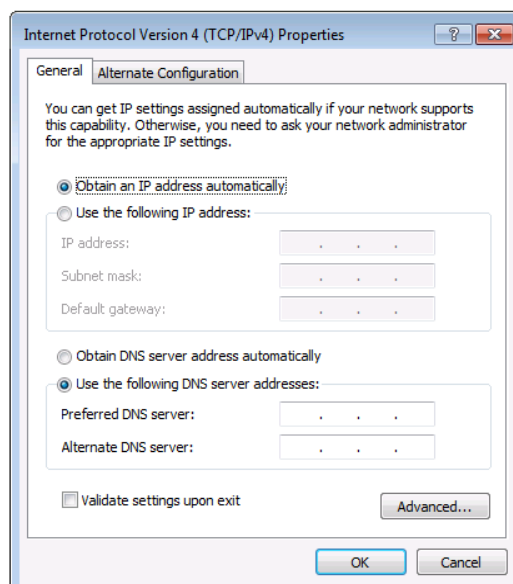

Figure 7: Internet Protocol Version 4 Properties Window

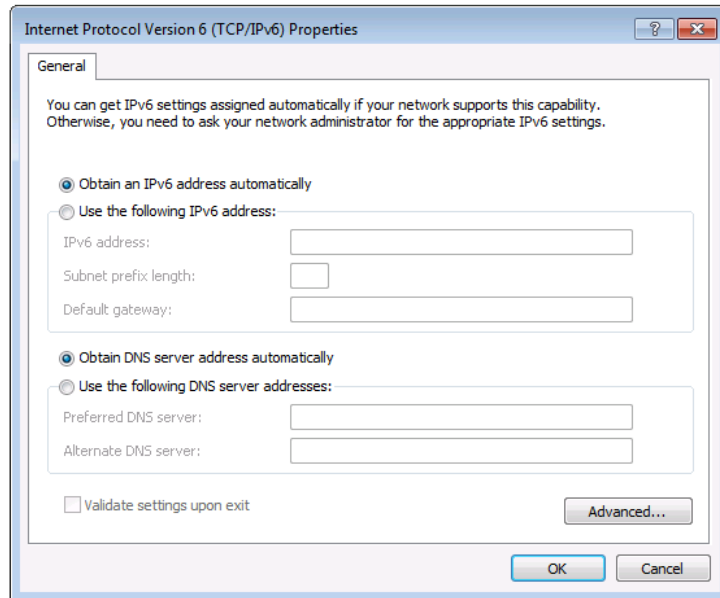

Figure 8: Internet Protocol Version 6 Properties Window

6. Select **Use the following IP Address** for static IP addressing and fill in the details as shown in [Figure 9](#).

For TCP/IPv4 you can use any IP address in the range 192.168.1.1 to 192.168.1.255 (excluding 192.168.1.39) that is provided by your IT department.

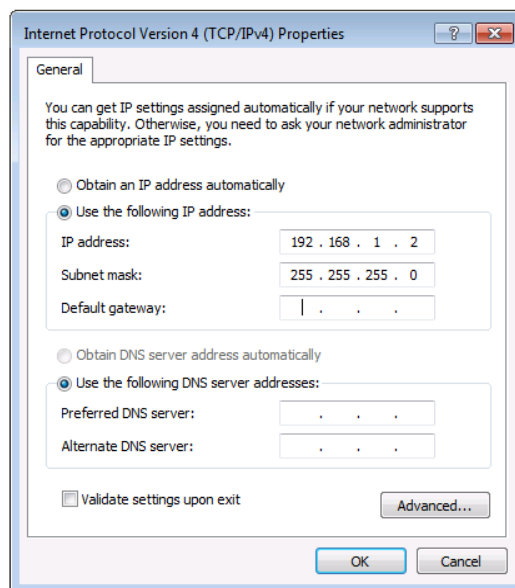

Figure 9: Internet Protocol Properties Window

7. Click **OK**.
8. Click **Close**.

Connecting Ethernet Port via a Network Hub or Switch

You can connect the Ethernet port of **VP-427X1** to the Ethernet port on a network hub or using a straight-through cable with RJ-45 connectors.

Configuring Ethernet Port

You can set the Ethernet parameters via the embedded Web pages.

Using Embedded Web Pages

VP-427X1 can be operated remotely using the embedded Web pages. The Web pages are accessed using a Web browser and an Ethernet connection.

Before attempting to connect:

- Perform the procedures in [Operating via Ethernet](#) on page [18](#).
- Ensure that your browser is supported.

The following operating systems and Web browsers are supported:

Operating Systems	Browser
Windows 7	IE
	Firefox
	Chrome
	Safari
Windows 10	IE
	Edge
	Firefox
	Chrome
Mac	Safari
iOS	Safari
Android	N/A



Some features might not be supported by some mobile device operating systems.

VP-427X1 enables performing the following:

- [Loading and Saving Configurations](#) on page [23](#).
- [Entering Standby Mode](#) on page [23](#).
- [Configuring Video Input Settings](#) on page [24](#).
- [Selecting an Input](#) on page [25](#).
- [Freezing or Blanking the Video Output Signal](#) on page [25](#).
- [Adjusting the Output Volume](#) on page [25](#).
- [Upgrading the Firmware](#) on page [27](#).
- [Configuring Network Settings](#) on page [28](#).
- [Performing Device Soft Factory Reset](#) on page [29](#).
- [Configuring Video Output Settings](#) on page [29](#).
- [Configuring HDCP per Input/Output](#) on page [30](#).
- [Managing EDID](#) on page [31](#).
- [Adjusting the Audio Delay and Volume](#) on page [33](#).

- [Configuring Automatic Switching Settings](#) on page [34](#).
- [Defining CEC Functionality](#) on page [35](#).
- [Controlling VP-427X1 via the RS-232 Terminal Block Connectors](#) on page [36](#).
- [Managing Authentication](#) on page [44](#).
- [Viewing About Page](#) on page [46](#).

To browse the VP-427X1 web pages:

1. Open your Internet browser.
2. Type the IP address of the device in the Address bar of your browser. For example, the default IP address:



The Controller application page appears.

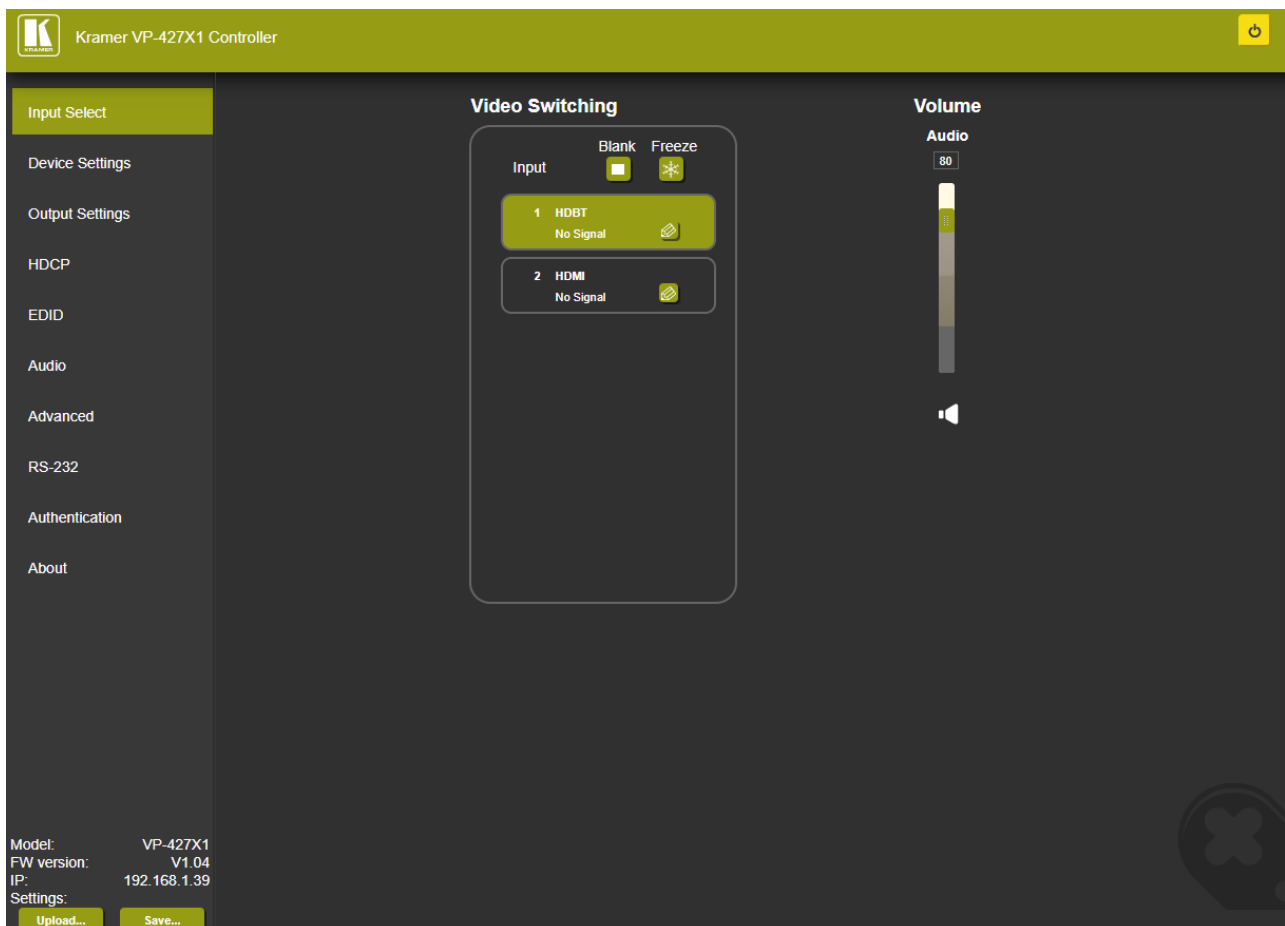

Figure 10: Controller Application Page with Navigation List on Left

3. Click the tabs on the left side of the screen to access the relevant web page.

Loading and Saving Configurations

VP-427X1 enables you to save a configuration to recall it in the future.

Saving a Configuration

To save the current configuration:

1. Configure the device as required.
2. In the Navigation pane, click **Save**.
The file is automatically saved in the Downloads folder (or another designated folder).

The current configuration is saved.

Loading a Configuration

To load a configuration:

1. In the navigation pane click **Upload**.
An Explorer window opens.
2. Select the required file and click **Open**.

The device is configured according to the saved preset.

Entering Standby Mode

VP-427X1 features a power saving standby mode that shuts down its outputs without having to power off the unit.

To toggle between standby mode and normal operation:

- Click the power icon on the right-hand side of the web pages header.
When in standby mode, the icon displays a gray background:



Figure 11: VP-427X1 Standby Mode

Configuring Video Input Settings

VP-427X1 enables you to individually configure settings for each of the video inputs.

To configure video input settings:

- 1. Click **Input Select** on the Navigation List.
The Input Select page appears ([Figure 10](#)).

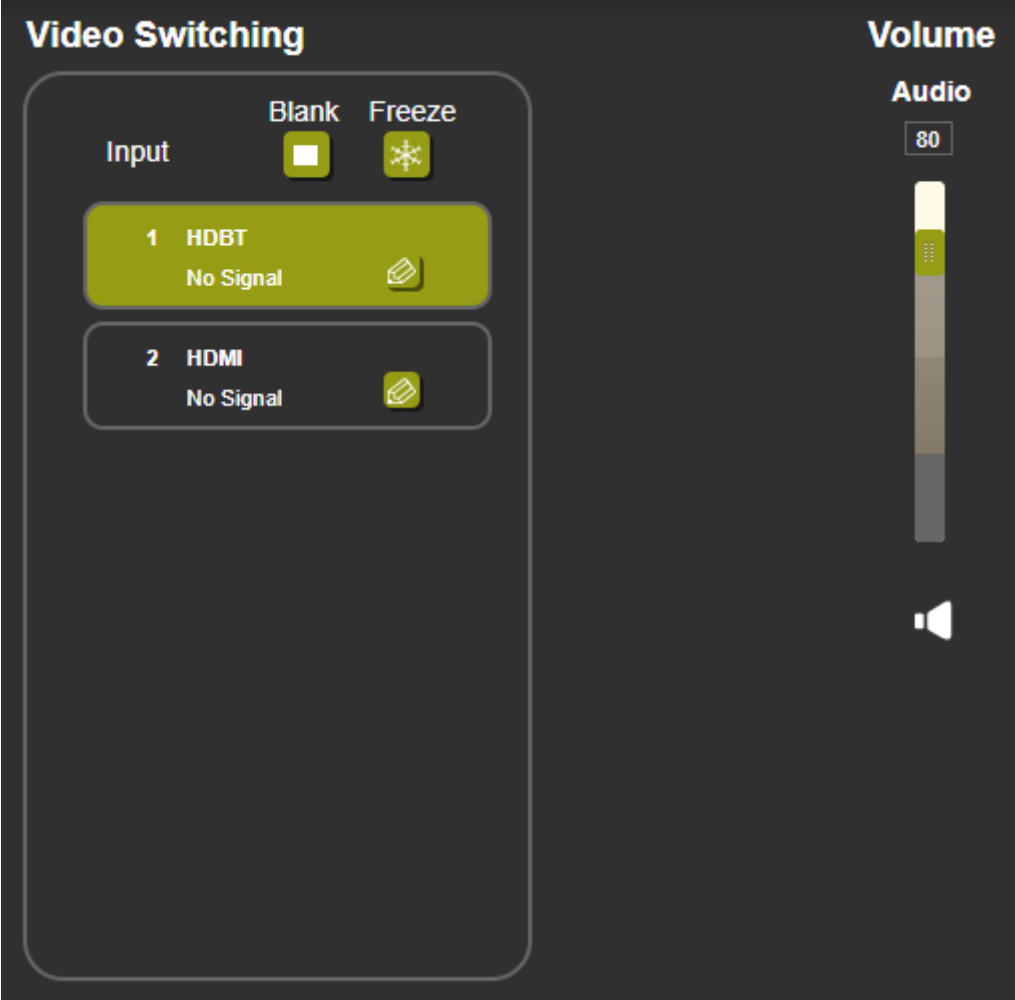

Figure 12: Web Pages – Input Select Page

- 2. In the Video Switching area, click the edit icon on the right side of the relevant video input.
The settings window appears for the selected input.

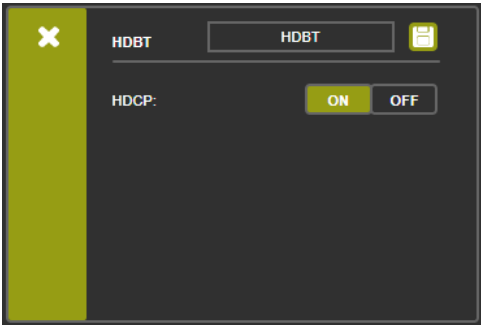

Figure 13: Setting Window for HDBT

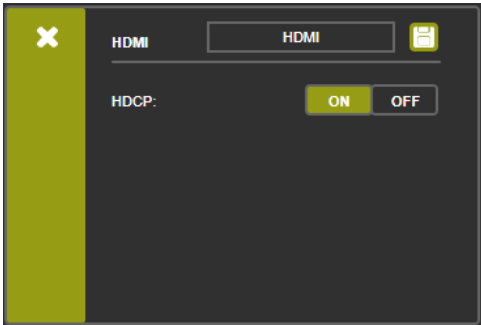

Figure 14: Setting Window for HDMI

3. If required, enter a new name, and click the save icon to change the name of the input that appears in the web pages.
4. Click **ON/OFF** to enable/disable the HDCP decryption on the selected input.



If HDCP is disabled on an input, an HDCP encrypted source will not pass through the unit.

Inputs are configured.

Selecting an Input



To select an input to be switched to the output using the web pages:

1. Click **Input Select** on the Navigation List.
The Input Select page appears ([Figure 10](#)).
2. In the Video Switching area, click the required input button.
The input button turns green

The selected input is switched to the output.

Freezing or Blanking the Video Output Signal

To freeze or clear the video output, do one of the following:

1. Click **Input Select** on the Navigation List.
The Input Select page appears ([Figure 10](#)).
2. In the Video Switching area, click one of the following:
 -  – Freezes the currently displayed video frame.
 -  To define what happens when you press the Freeze button, see [Defining FREEZE Button Operation Mode](#) on page [16](#).
 -  – Blanks the video output from the display; the display goes blank.

Output video signal is frozen/blanked.

Adjusting the Output Volume



The analog audio output volume can also be adjusted from the Audio web page.

To adjust the output volume:

1. Click **Input Select** on the Navigation List.
The Input Select page appears ([Figure 10](#)).
2. Use the slider controls in the Volume area of the web page to change the volume or enter the value in the text box above the slider.
3. Click  to mute the output.

Audio output volume is adjusted.

Viewing Device Details

1. Click **Device Settings** on the Navigation List.
The Device Settings page appears.

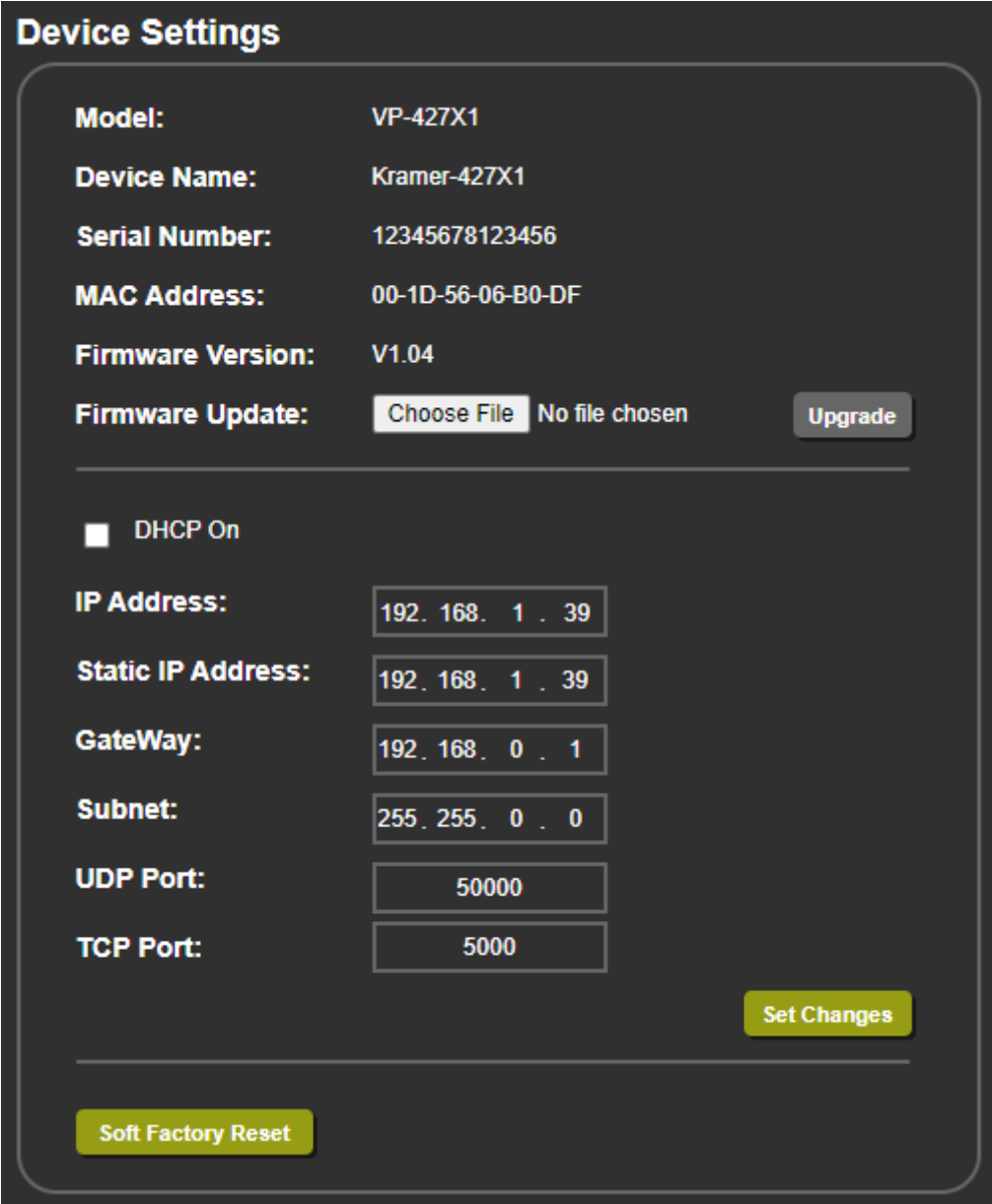

Figure 15: The Device Settings Page

2. Under Device Settings, view device details: Model, Device Name, Serial Number, MAC Address and Firmware Version.

Device details are viewed.

Upgrading the Firmware

To upgrade VP-427X1 firmware:

1. Click **Device Settings** on the Navigation List.
The Device Settings page appears (see [Figure 15](#)).
2. Under Firmware Update, click **Choose File**.
A file browser appears.
3. Open the required upgrade file.
The file name appears on the web page.
4. Click **Upgrade**.
a confirmation window appears.
5. Click **OK**. The new firmware is uploaded:

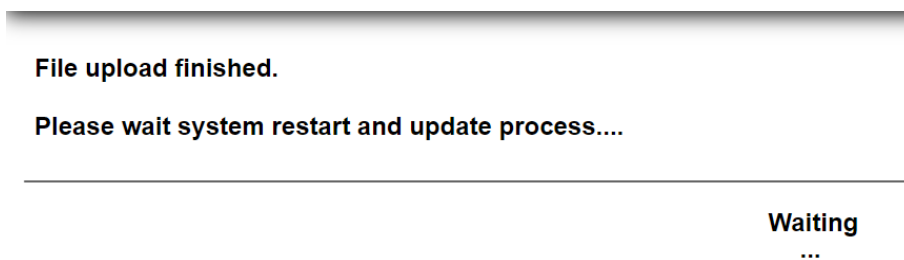

Figure 16: Device Settings Page –New Firmware Uploaded

6. Once the file is uploaded follow the instructions on the web page:
The new firmware is uploaded:

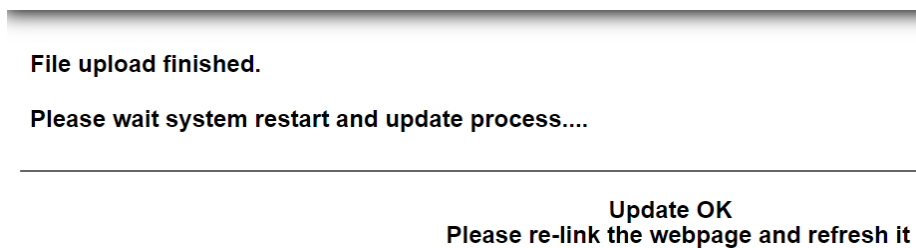

Figure 17: Device Settings Page – New Firmware File Uploading Complete

7. Re-enter the IP address and refresh the web page.
8. Make sure that the new version appears on the lower left side of the web page.

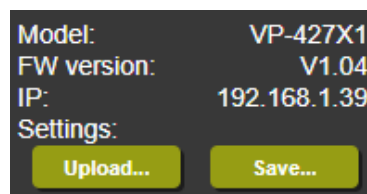

Figure 18: Current Firmware Information Display

Firmware upgrade is complete.

Configuring Network Settings

VP-427X1 enables you to use DHCP mode or to turn DHCP mode off and change Network settings.

To configure Network settings:

1. Click **Device Settings** on the Navigation List.
The Device Settings page appears (see [Figure 15](#)).
2. Change Network settings as required:
 - a. In static mode (DHCP On is unchecked), change static Network settings as required:
 - For example, change the IP address.

The screenshot shows a dark-themed web interface for network configuration. At the top left, there is a checkbox labeled 'DHCP On' which is currently unchecked. Below this, several fields are listed with their corresponding values in input boxes:

- IP Address:** 192.168.1.39
- Static IP Address:** 192.168.1.38
- GateWay:** 192.168.0.1
- Subnet:** 255.255.0.0
- UDP Port:** 50000
- TCP Port:** 5000

In the bottom right corner, there is a yellow button labeled 'Set Changes'.

Figure 19: Changing the IP Address

- Click **Set Changes**. A confirmation message appears.
- b. To select to work in DHCP mode instead of with static parameters, select the **DHCP On** check box and click **Set changes**. A confirmation message appears.
3. Click **OK** to confirm the change.
The current web page session is disconnected. To access the web pages, reload with the new setting.

Network settings are configured.

Performing Device Soft Factory Reset

VP-427X1 enables you to reset to factory default settings, with or without resetting the IP parameters.

To perform soft factory reset:

1. Click **Device Settings** on the Navigation List.
The Device Settings page appears (see [Figure 15](#)).
2. Click **Soft Factory Reset** to restart the unit.
IP address values and User/Password settings do not return to their factory default parameters.

The device resets.



For full factory reset, see [Performing a Reset](#) on page [18](#).

Configuring Video Output Settings

VP-427X1 enables you to configure settings for the video that is passed through the HDBT and HDMI outputs.

To configure video output settings:

1. Click **Output Settings** on the Navigation List.
The Output Settings page appears.

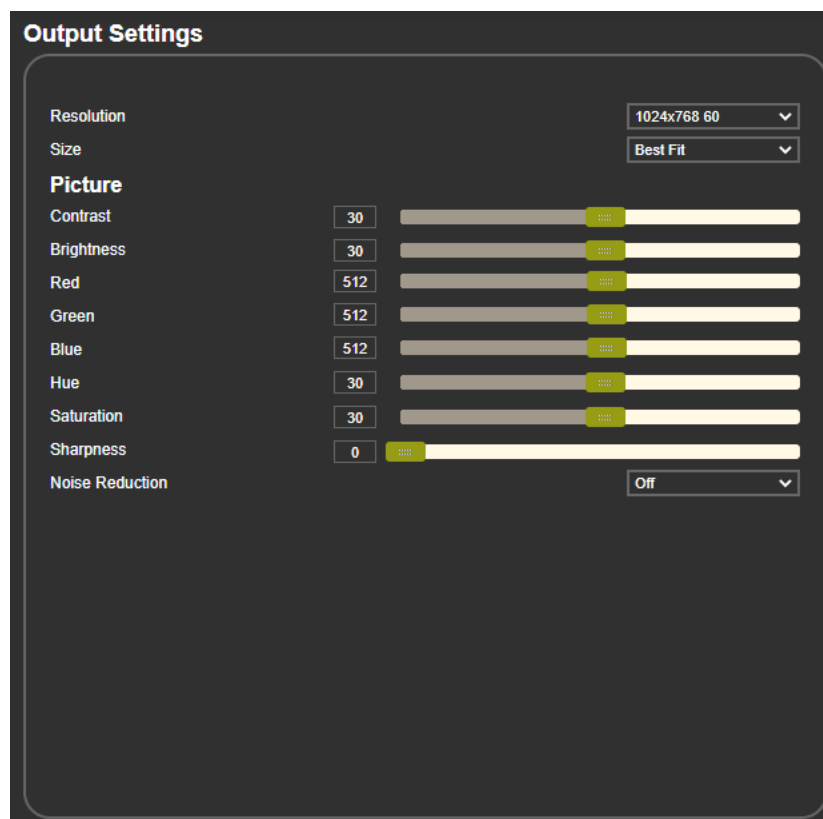

Figure 20: The Output Settings Page

2. Open the Resolution drop-down box and select the required output resolution or select one of the following:
 - Native – sets the output resolution to match the native resolution of the connected device.
3. Open the Size drop-down box and select the video size on the display: Over Scan, Full, Best Fit, Pan Scan, Letter Box, Under 2, Under 1 and Follow In.
4. In the Picture area, use the slider controls to adjust the display picture quality.
5. Open the Noise Reduction drop-down box and select the level of noise reduction or select Off.

Output settings are defined.

Configuring HDCP per Input/Output

VP-427X1 enables you to configure HDCP individually for each input/output.

To configure HDCP:

1. Click **HDCP** on the Navigation List.
The HDCP page appears.

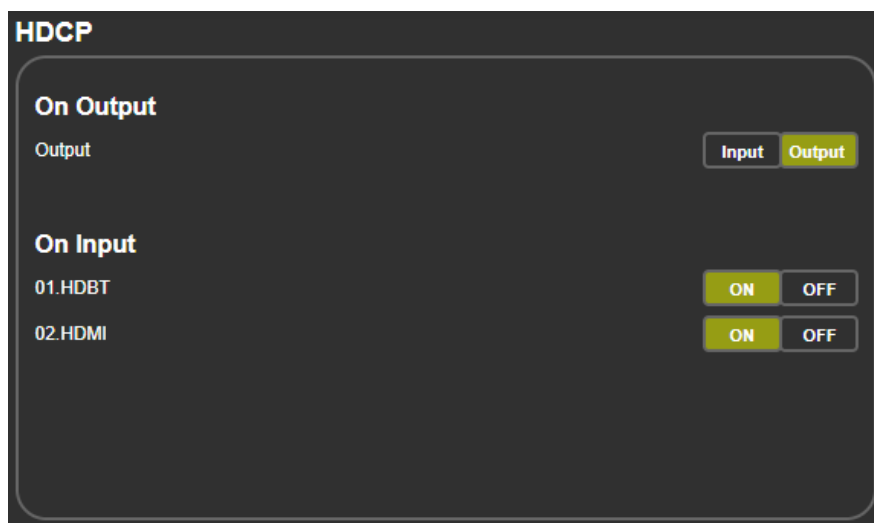

Figure 21: The HDCP Page

2. In the On Output area, click one of the following:
 - **Input** – signal is outputted with HDCP encryption when the input includes HDCP encryption.
 - **Output** – signal is always outputted with HDCP encryption when the output acceptor supports it (even if the input does not include encryption).
3. In the On Input area, click **ON** or **OFF** for each of the inputs to turn on or off the HDCP encryption for that input.

HDCP settings are defined.

Managing EDID

VP-427X1 enables you to individually configure and manage EDID settings for each of the inputs.

To Copy EDID:

1. Click **EDID** on the Navigation List.
The EDID page appears.

EDID

Read from:

Output:

HDMI Out

Default:

1080p

1080p(Aud)

4k2k3G

4k2k3G(Aud)

4k2k6G

4k2k6G(Aud)

Browse...

Copy to:

Inputs

HDBT

HDMI

Copy

NONE

to

NONE

Figure 22: The EDID Page

2. Under Read from, click the required EDID source or click **Browse** to use an EDID configuration File.

- Under Copy to, click the inputs to copy the selected EDID to. The Copy button is enabled.

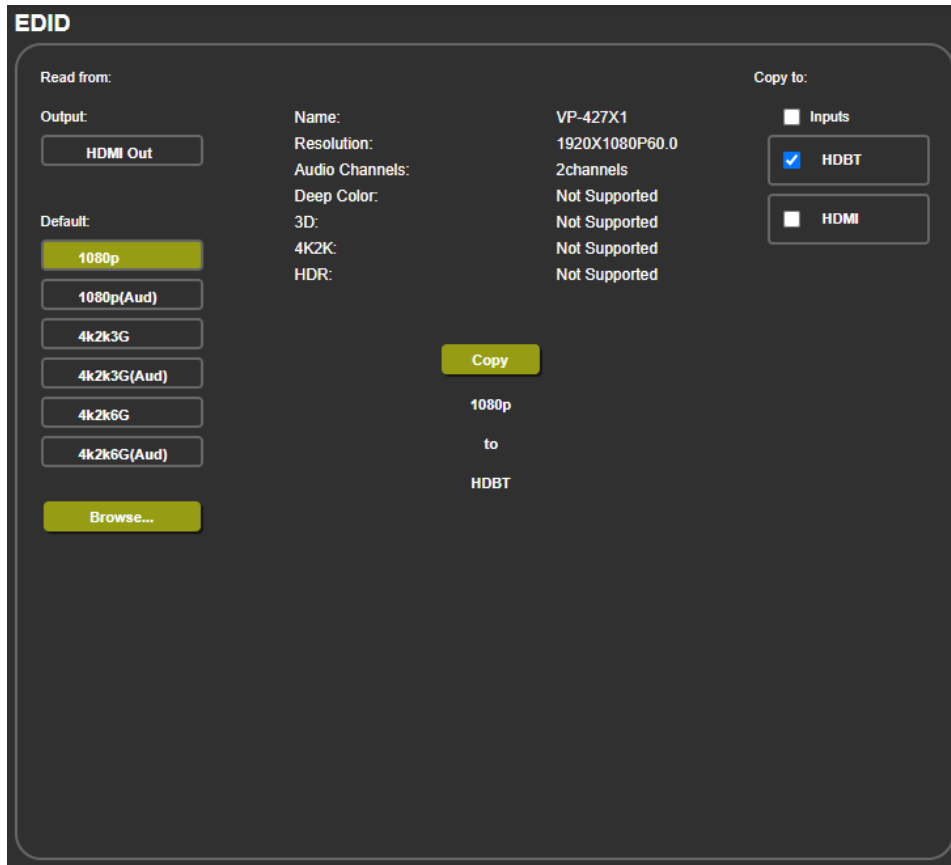

Figure 23: Selecting the EDID and Inputs

- Click **Copy**.

The selected EDID is copied to the selected inputs and the Copy EDID Results message appears.

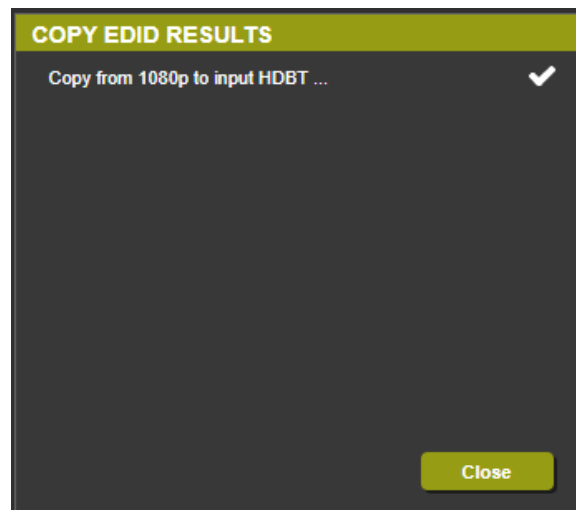

Figure 24: The EDID Page – The Copy EDID Results

- Click **Close**.

EDID is copied.

Adjusting the Audio Delay and Volume

VP-427X1 enables you to define the audio delay value (for lip-sync adjustment) and to set the analog audio volume.

To adjust the audio settings:

1. Click **Audio** on the Navigation List.
The Audio page appears.

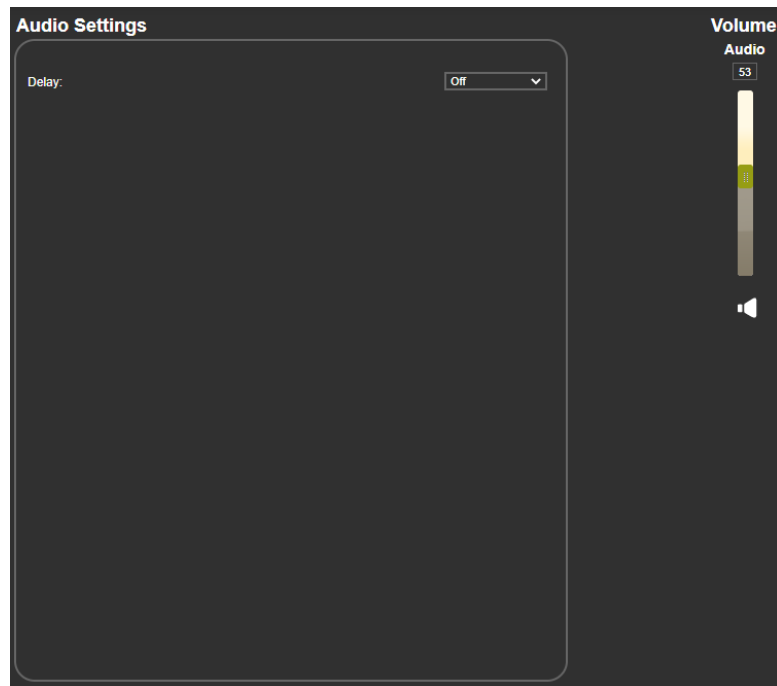

Figure 25: The Audio Settings Page

2. For Delay, select a time value in milliseconds.
3. Use the slider controls or enter a number from 0 to 100 in the field to adjust the volume of the analog audio output.

Audio settings are defined.

Configuring Automatic Switching Settings

To configure automatic switching settings:

1. Click **Advanced** on the Navigation List.
The Advanced page appears.

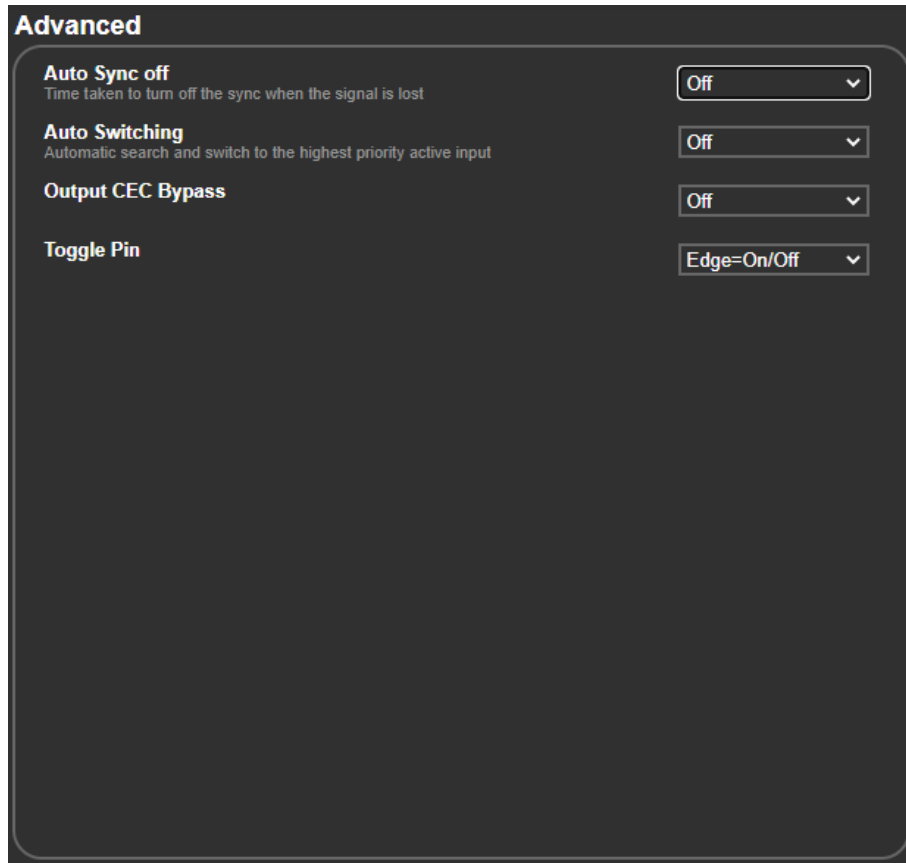

Figure 26: The Advanced Page

2. Define Auto Sync Off:
 - Off – disable the Auto Sync Off feature.
 - Fast – shuts down after about 10 seconds.
 - Slow – shuts down after about 2 minutes.
 - Immediate – shuts down immediately.
3. Define Auto Switching:
 - Off – Disable auto switching.
 - Auto Scan – set auto-scanning.
 - Last connected – when detecting that a source is connected to an input (which previously had no signal), automatically switch to that input.

Auto Switching is defined.

Defining CEC Functionality

Define whether the unit automatically sends CEC on/off commands to the display (default) or whether it passes CEC commands from the source to the display (see [Defining CEC](#) on page [17](#)).

To define the CEC behavior:

1. Click **Advanced** on the Navigation List.
The Advanced page appears.
2. Define Output CEC Bypass from the drop-down box:
 - Off – Automatically send CEC commands to shut down the output display after a timeout period when no input signal is found and to power up the display when the input returns.
 - On – Pass CEC commands from the source to the display.

CEC functionality is defined.

Defining the TOGGLE Pin Behavior

VP-427X1 enables defining the function of the REMOTE pin [15](#) on the rear panel.

To configure the TOGGLE pin (see [Connecting the Remote Control Switches](#) on page [9](#)):

1. Click **Advanced** on the Navigation List.
The Advanced page appears.
2. Select the TOGGLE pin configuration from the drop-down box:
 - Edge = (toggle on/off).
 - Input Select.
 - GND=Off / Hi=On
 - GND=On / Hi=Off
 - Hi=Off
 - Hi=On
 - GND=Off
 - GND=On

TOGGLE pin button is defined.

Controlling VP-427X1 via the RS-232 Terminal Block Connectors

Configure the VP-427X1 RS-232 port to control the device, control an external device, or for tunneling of RS-232 commands via HDBT or via the Ethernet.

Use the RS-232 CONTROL port (12) to perform the following actions:

- [Controlling VP-427X1 via the RS-232 Port](#) on page [37](#).
- [Controlling an External Device Via the RS-232 Port](#) on page [38](#).
- [Controlling an RS-232 External Device Via Local Ethernet Tunneling](#) on page [40](#).
- [Controlling an RS-232 External Device Via HDBT Tunneling](#) on page [41](#).
- [Controlling VP-427X1 Via HDBT Tunneling](#) on page [42](#).
- [Controlling an External Device Via HDBT Ethernet Tunneling](#) on page [43](#).

Controlling VP-427X1 via the RS-232 Port

Connect the RS-232 port to a system controller to control the VP-427X1.

To control VP-427X1 via RS-232:

1. Connect a controlling system to the RS-232 port
(see [Connecting to VP-427X1 via RS-232](#) on page 8).

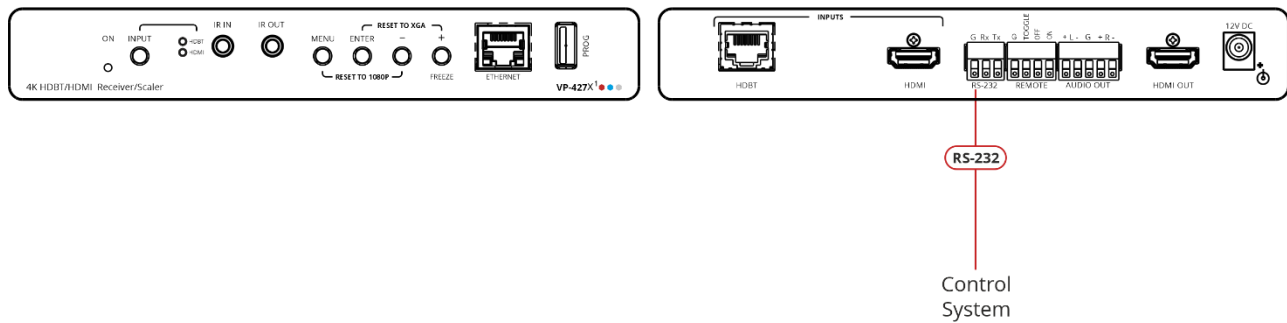

Figure 27: Local Scaler Control

2. Click **RS-232** on the Navigation List. The RS-232 page appears.
3. Set “Use RS-232 Port for control of” drop-down box to **Scaler (local)**.

The screenshot shows the RS-232 configuration page. At the top, there is a dropdown menu labeled "Use RS-232 Port for control of" with "Scaler(local)" selected. Below this is the "RS-232 control of External Device" section, which includes "RS-232 Configuration" with the following settings: Baud Rate: 9600, Data Bits: 8, Parity: None, Stop Bits: 1, and Port: 5100. There is a "Port Set" button next to the Port field. Below the configuration is the "External Device commands configuration" section, which is a table with columns for Command, Description, Trigger, Delay(sec), Hex, and Enable. The table has one row with "5V On" in the Trigger column, a delay of 30 seconds, and two unchecked checkboxes for Hex and Enable. An "Add" button is located at the end of the table.

Command	Description	Trigger	Delay(sec)	Hex	Enable
		5V On	30	<input type="checkbox"/>	<input type="checkbox"/>

Figure 28: RS-232 Page – Controlling the VP-427X1

RS-232 port is used to control the VP-427X1.

Controlling an External Device Via the RS-232 Port

Control any external device (for example, the connected display) via RS-232 commands triggered by VP-427X1.

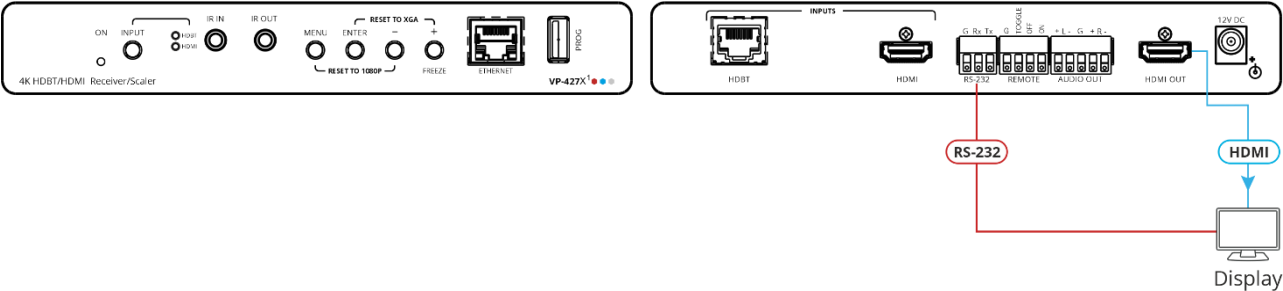

Figure 29: External Control

To control an external device via RS-232 port:

- 1. Click **RS-232** on the Navigation List. The RS-232 page appears.
- 2. Set “Use RS-232 Port for control of” drop-down box to **External Control**.

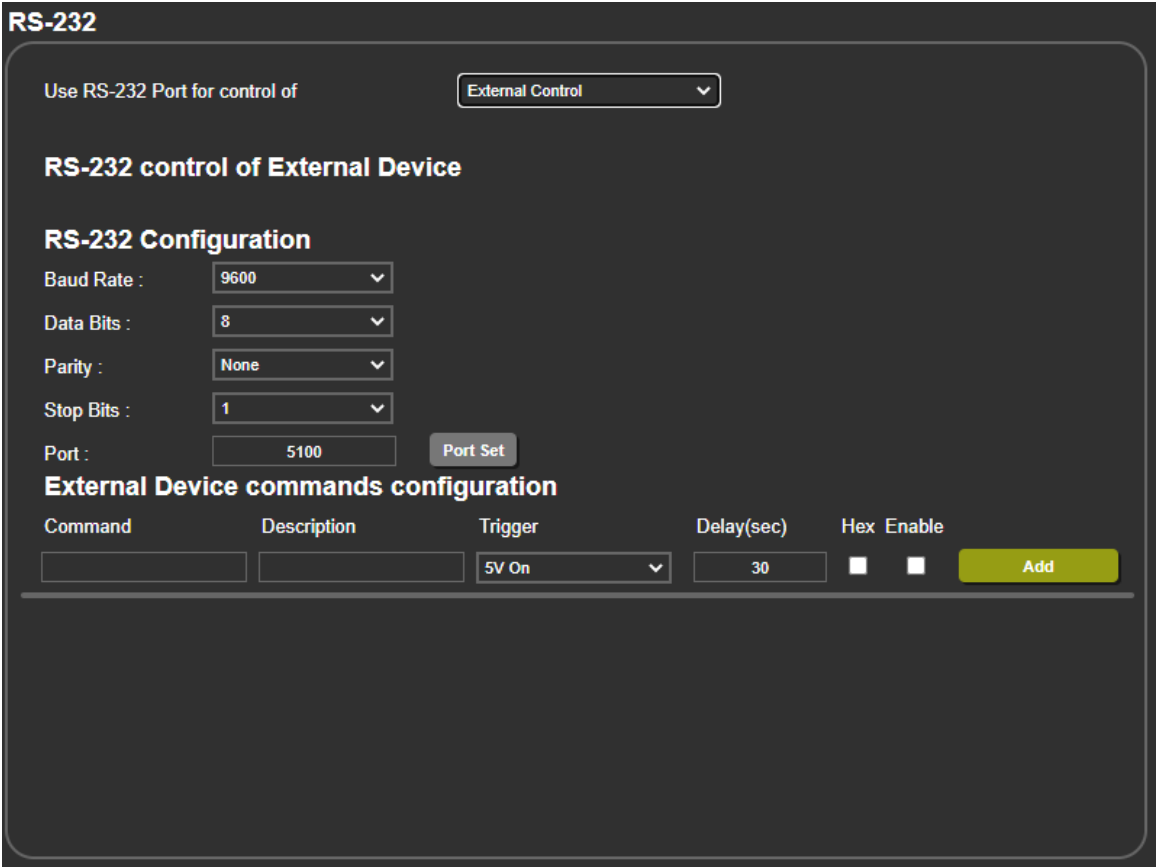

Figure 30: RS-232 Page – Controlling an External Device

- Set RS-232 Configuration parameters to enable communication with the display that is connected to the acceptor (or any other device with an RS-232 port).

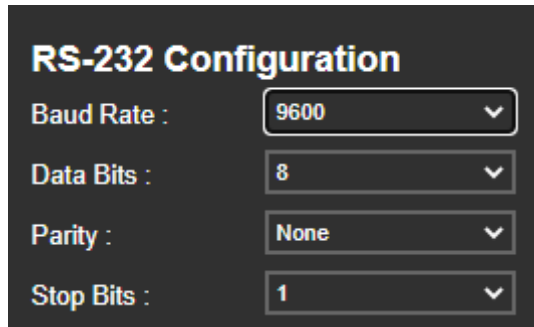

Figure 31: RS-232 Device Configuration Parameters

- Configure the external device commands as follows:
 - Enter a device command (for example, turn POWER OFF).
 - Enter the command description (for example, Turn Display Off).
 - Select a trigger from the drop-down box to carry out the command (**5V On, 5V Off, Sync/Clock, No Sync/No Clock**).
 - Enter a delay time, if required.
 - Check Hex for Hex command format, if required.
 - Check **Enable** to enable the command.

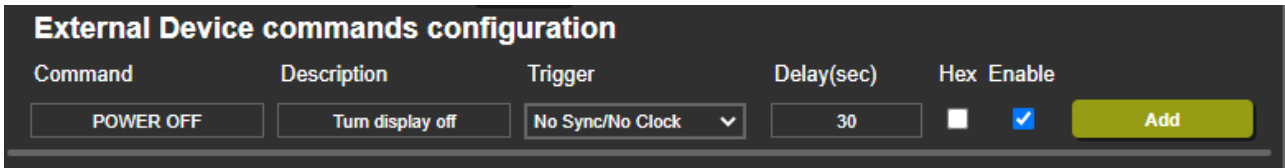

Figure 32: RS-232 Page – Creating a Command

- Click **Add**.

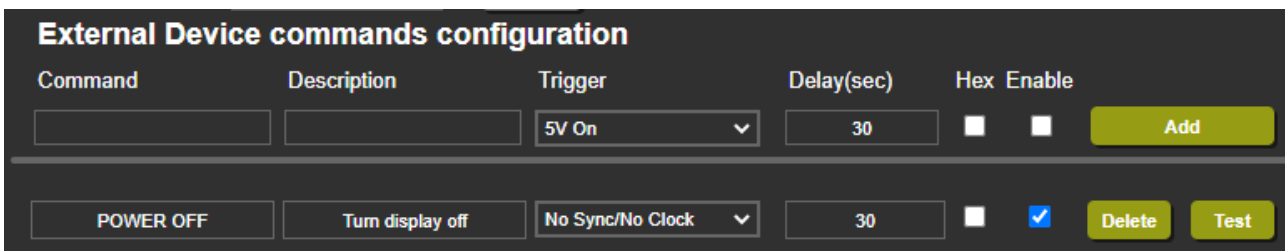

Figure 33: RS-232 Page – Command Added

- You can:
 - Click **Delete** to delete the command.
 - Click **Test** to test the command.
 - Change any of the command configurations.
 - Enable or disable the command.

Commands are sent to the display via **VP-427X1** RS-232 port.

Controlling an RS-232 External Device Via Local Ethernet Tunneling

Control any external device (for example, the connected display) using RS-232 commands tunneled via VP-427X1's Ethernet port.

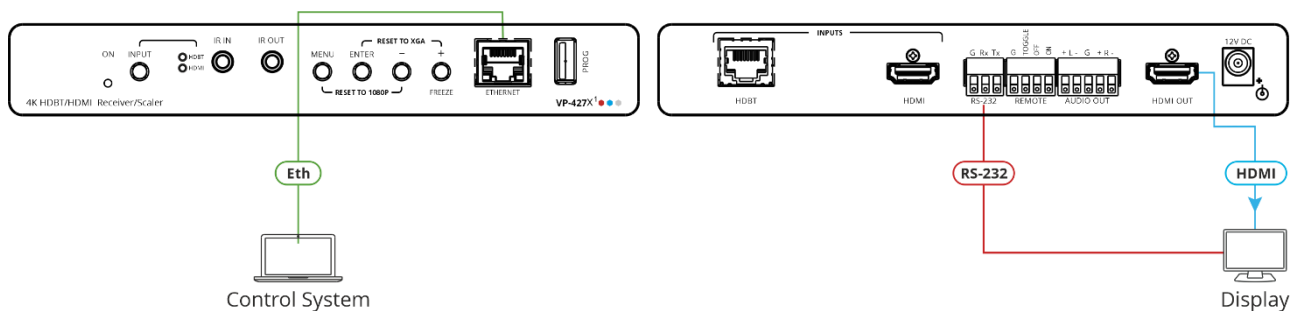

Figure 34: Local Ethernet Tunneling

RS-232 commands can be tunneled from the VP-427X1 Ethernet port to the RS-232 port that is connected to the external device.

To control an external device via local Ethernet Tunneling:

1. Click **RS-232** on the Navigation List. The RS-232 page appears.
2. Set “Use RS-232 Port for control of” drop-down box to **Ethernet Tunneling (Local)**.

Command	Description	Trigger	Delay(sec)	Hex	Enable
		5V On	30	<input type="checkbox"/>	<input type="checkbox"/>

Figure 35: RS-232 Page – Controlling an External Device via Local Ethernet Tunneling

3. Set RS-232 Configuration parameters to enable communication with the display that is connected to the acceptor (or any other device with an RS-232 port), see [Figure 31](#).

- 4. Set the tunneling port number (5100, by-default) and click **Port Set**.
 - 5. Send the display RS-232 commands via Ethernet tunneling.
- Commands are sent to the display via Ethernet tunneling.

Controlling an RS-232 External Device Via HDBT Tunneling

Control any external device (for example, the connected display) using an RS-232 controller connected to the transmitter wired to the HDBT input. RS-232 commands are sent from the control system to the transmitter and tunneled via HDBT to the **VP-427X1** and fed to the RS-232 device connected to **VP-427X1**.

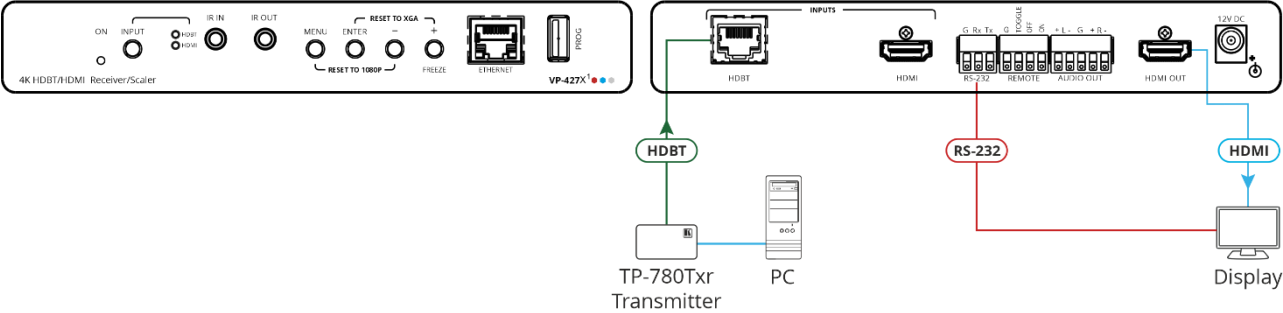

Figure 36: External Device Control via HDBT Tunneling

To control an external device via HDBT Tunneling to the RS-232 port:

- 1. Click **RS-232** on the Navigation List. The RS-232 page appears.
- 2. Set “Use RS-232 Port for control of” drop-down box to **Tunneling (HDBT)**.

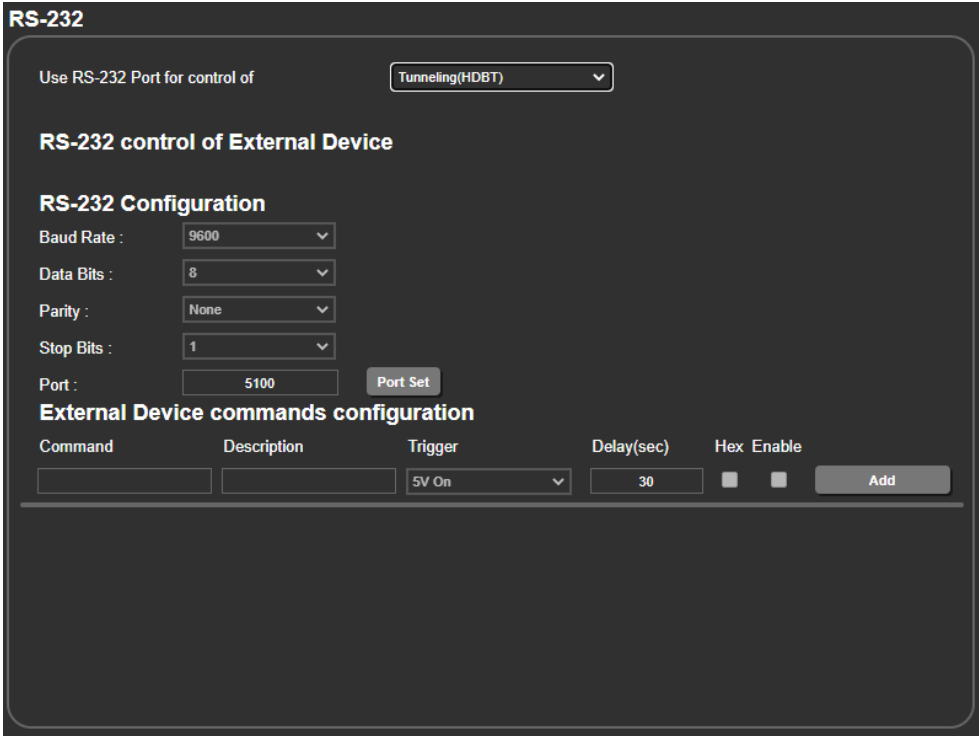

Figure 37: RS-232 Page – Controlling an External Device via HDBT Tunneling

- 3. Send the display RS-232 commands via HDBT tunneling.
- Commands are sent to the display via HDBT tunneling.

Controlling VP-427X1 Via HDBT Tunneling

Control VP-427X1 using an RS-232 control system connected to the transmitter on the HDBT input. RS-232 commands are sent from the control system connected to the transmitter and tunneled via HDBT to VP-427X1 to control it.



In this case, RS-232 terminal block connector is not operational.

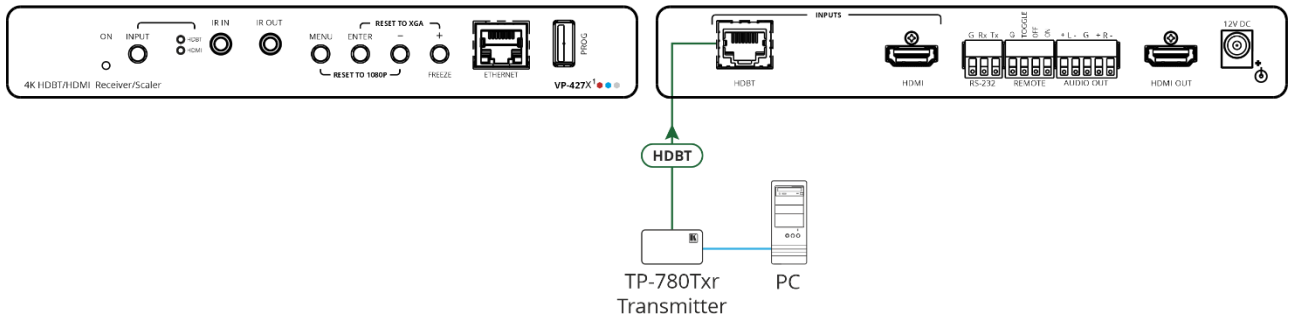

Figure 38: VP-427X1 Control via HDBT Tunneling

To control VP-427X1 via HDBT Tunneling to the RS-232 port:

1. Click **RS-232** on the Navigation List. The RS-232 page appears.
2. Set “Use RS-232 Port for control of” drop-down box to **Scaler (HDBT)**.



Figure 39: RS-232 Page – Controlling an External Device via HDBT Tunneling

3. Send the display RS-232 commands via HDBT tunneling.
Commands are sent to VP-427X1 via HDBT tunneling.

Controlling an External Device Via HDBT Ethernet Tunneling

Control any external device (for example, a connected display) using an Ethernet control system connected to the transmitter wired to the HDBT input. RS-232 commands are sent from the control system to the transmitter and tunneled via VP-427X1 HDBT to the RS-232 device connected to VP-427X1.

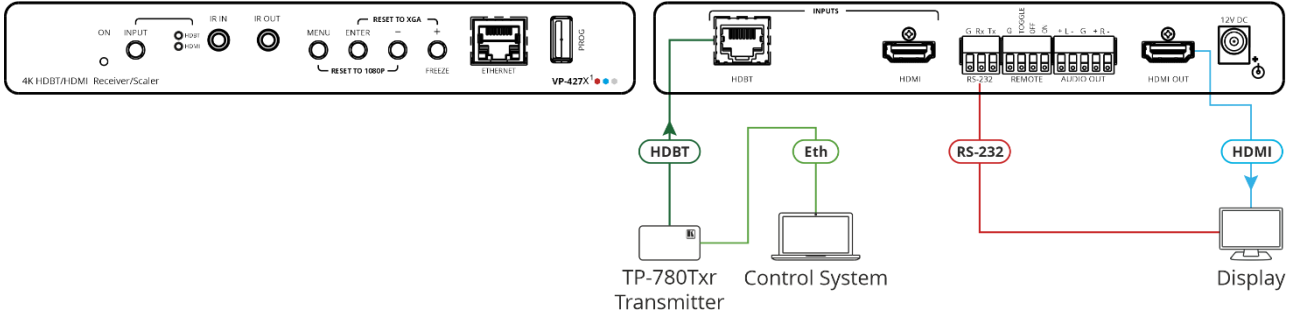

Figure 40: Ethernet Tunneling via HDBT

RS-232 commands can be tunneled from the VP-427X1 Ethernet port to the RS-232 port that is connected to the external device.

To control an external device via Ethernet Tunneling to the RS-232 port:

1. Click **RS-232** on the Navigation List. The RS-232 page appears.
2. Set “Use RS-232 Port for control of” drop-down box to **Ethernet Tunneling (HDBT)**.

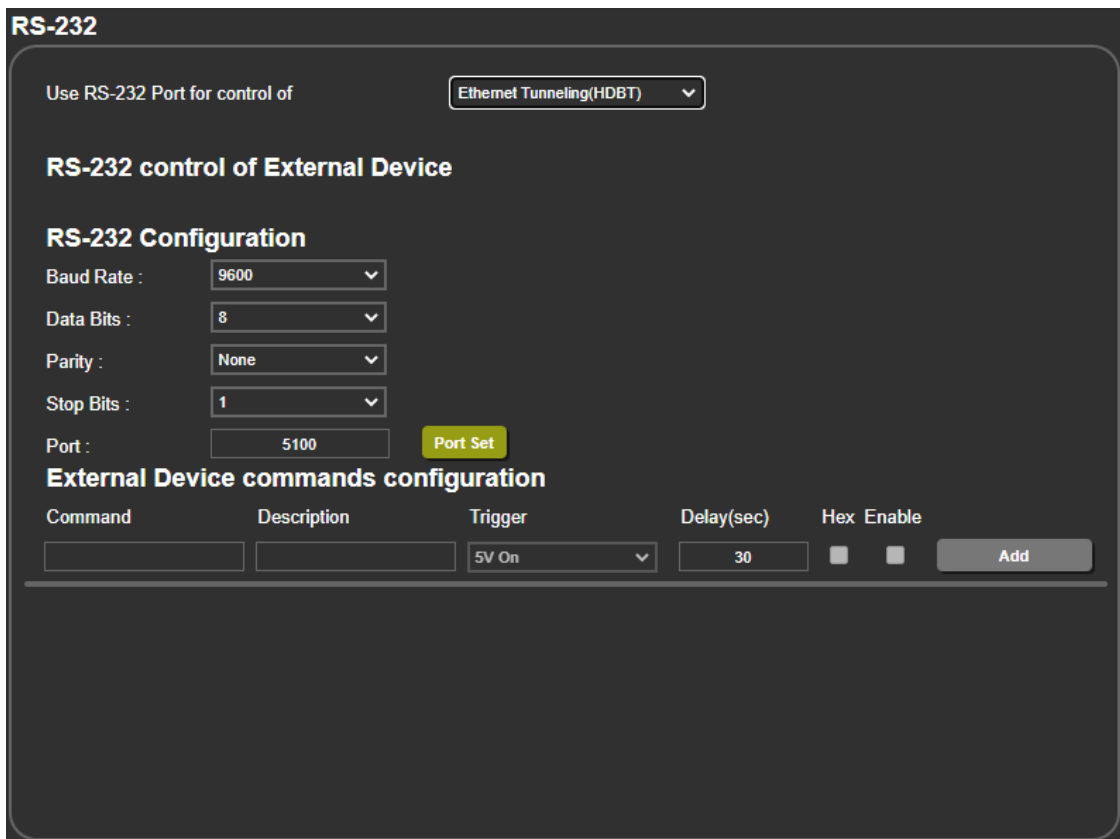

Figure 41: RS-232 Page – Controlling an External Device

3. Set RS-232 Configuration parameters to enable communication with the display that is connected to the acceptor (or any other device with an RS-232 port), see [Figure 31](#).

4. Set the tunneling port number (5100, by-default) and click **Port Set**.
5. Send the display RS-232 commands via HDBT Ethernet tunneling.
Commands are sent to the display via HDBT Ethernet tunneling.

Managing Authentication

By default, the web pages are not secured. This section describes how to change the password and disable/enable access permission.

You can perform the following functions:

Securing Web Pages

To secure the Web pages with a user name and password:

1. In the Navigation pane, click **Authentication**. The Authentication page appears.

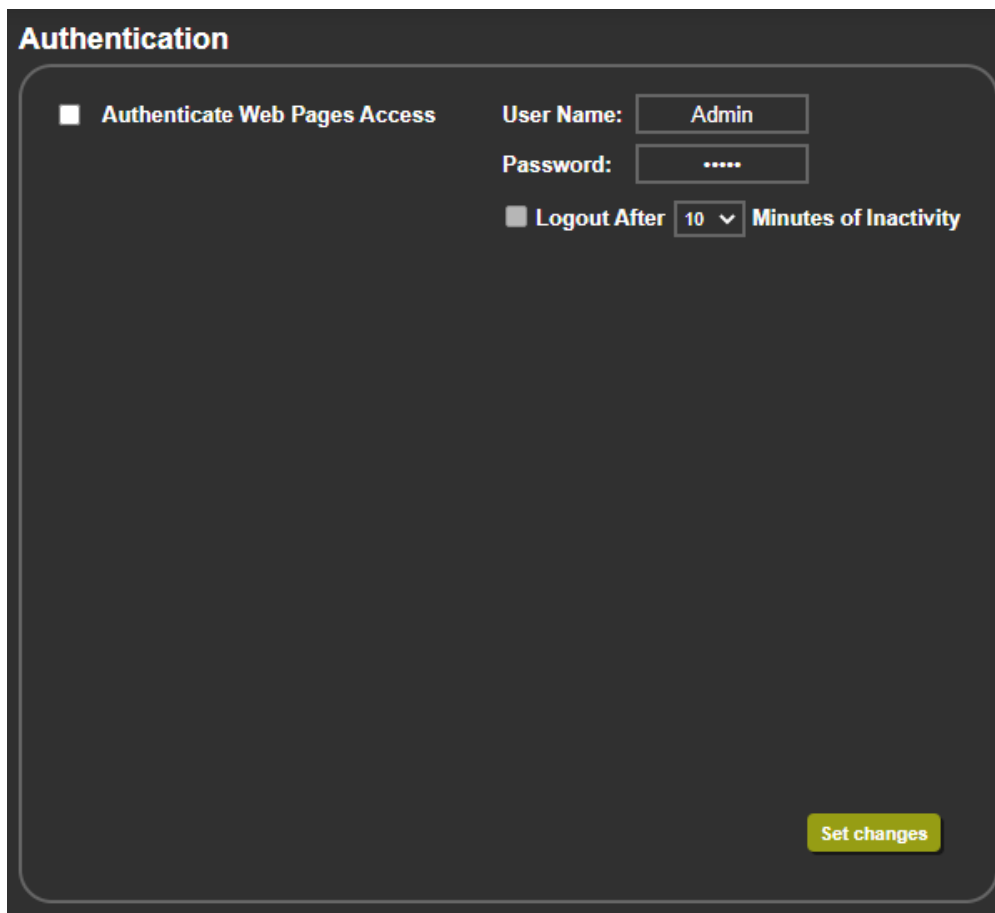

Figure 42: Authentication Page

2. Check **Authenticate Web Pages access** to indicate that you want the web pages to lock.
3. Fill in a **user name** (the default is Admin).
4. Fill in a **password** (the default is Admin).

5. If you want the unit to automatically logout after a set number of minutes of inactivity, check the box indicating **Logout After**, and set the number of minutes to wait before locking the webpages.
6. Click **Set changes**.

The web pages lock according to settings.

Accessing Web Pages with a Password

When the web pages are locked, you will be prompted for your user name and password.

To access secured web pages:

1. In the Navigation pane, click **Authentication**. The Authentication page appears. [\(Figure 42\)](#).
2. Enter the correct username and password.
3. Click the right arrow.

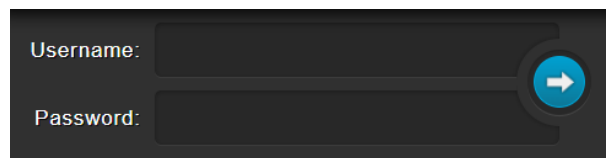

Figure 43: Prompt to unlock Web Pages

Web pages are secured.

Removing Password

To remove password protection from web pages:

1. In the Navigation pane, click **Authentication**. The Authentication page appears. [\(Figure 42\)](#).
2. Uncheck **Authenticate Web Pages access** to indicate that you do not want the webpages to lock.
3. Click **Set changes**. A confirmation message appears.

Web pages are not password protected.

Changing Password

To change the password:

1. In the Navigation pane, click **Authentication**. The Authentication page appears. [\(Figure 42\)](#).
2. Enter the new Password.
3. Click **Set changes**. A confirmation message appears.

Password has changed.

Viewing About Page

View the Web page version and Kramer Electronics Ltd details in the About page.



Figure 44: The About Page

Upgrading Firmware

Upgrade the firmware in any of the following ways:

- Connecting the device to your PC and using Kramer **K-UPLOAD** software.
- Via PROG USB port ⁽¹¹⁾ (see [USB Firmware Upgrade \(USB Format FAT32\)](#) on page 47).
- Via the embedded web pages (see [Upgrading the Firmware](#) on page 27).

The latest version of **K-UPLOAD** and installation instructions can be downloaded from our website at: www.kramerav.com/support/product_downloads.asp.

USB Firmware Upgrade (USB Format FAT32)

To update the firmware via PROG USB port:

1. Save VP_427X1 bin. file (for example, VP_427X1_all_V*.bin) in USB flash driver and plug into PROG USB port.
2. Press and hold ENTER+DOWN button for about 3 seconds until the two HDBT/HDMI INPUT LEDs are lit, and then release buttons.
the device enters USB mode and firmware upgrade starts.
Upon completion (after about 30 seconds), the device reboots.



If the device is in USB mode but can't read the firmware file or if the USB flash driver is not connected, it reboots automatically after 10 seconds and exits the USB mode.



If the power drops during firmware upgrade, it automatically starts upgrading once the power is back.

If the power drops in the early stages of firmware upgrade, you need to start firmware upgrade again.

Technical Specifications

Inputs	HDBaseT	On an RJ-45 connector
	HDMI	On a female HDMI connector
Outputs	HDMI	On a female HDMI connector
	Balanced Analog Stereo Audio	On a 5-pin terminal block connector
Ports	IR	On a 3.5mm mini jack
	RS-232	On a 3-pin terminal
	Ethernet	On an RJ-45 female connector
Video	Max. Range	180m (590ft) at 1080p@60Hz 100m (328ft) at 4K@60Hz (4:2:0)
	Max. Resolution	HDMI: 4K @60Hz (4:4:4) HDBT: 4K @60Hz (4:2:0)
	Latency	Up to 2 frames
	Content Protection	HDCP 2.2/1.4
	Switching Time Between Inputs	<2.5 seconds (constant output sync)
Audio	Output Impedance	500Ω
	S/N Ratio	>95dB (A-Weighted)
	THD+Noise	<0.003% @1kHz at 1Vpp
	Crosstalk	<-94dB @1kHz
	Output coupling	DC
	Maximum Output Level	14dBu
Extended Ethernet	Max Transmission Bandwidth	100BT
Extended RS-232	Baud Rate	4800 to 115200 baud
Control RS-232	Baud Rate	115200 baud
User Interface	Control	Input selection buttons, remote contact-closure switches. Kramer API via RS-232 serial commands transmitted by a PC, touch screen system or other serial controller, embedded web pages via LAN for configuration and control
	Indicators	Power, link, input selection LEDs
Power	Consumption	12V DC, 1500mA
	Source	PoE or 12V DC, 5A
Environmental Conditions	Operating Temperature	0° to +40°C (32° to 104°F)
	Storage Temperature	-40° to +70°C (-40° to 158°F)
	Humidity	10% to 90%, RHL non-condensing
Regulatory Compliance	Safety	CE, FCC
	Environmental	RoHs, WEEE
Enclosure	Size	MegaTOOLS®, deep
	Type	Aluminum
	Cooling	Convection Ventilation
General	Net Dimensions (W, D, H)	18.8cm x 14.5cm x 2.54cm (7.4" x 5.7" x 1")
	Shipping Dimensions (W, D, H)	35.1cm x 21.2cm x 7.2cm (13.8" x 8.4" x 2.8")
	Net Weight	0.9kg (2.0lbs) approx.
	Shipping Weight	1.1kg (2.4lbs) approx.
Accessories	Included	Power cord and adapter
Specifications are subject to change without notice at www.kramerav.com		

Default Communication Parameters

RS-232	
Baud Rate:	115,200
Data Bits:	8
Stop Bits:	1
Parity:	None
Command Format:	ASCII
Example (Route video HDBT INPUT to HDMI OUTPUT):	#ROUTE_1,1,1<CR>
Ethernet	
To reset the IP settings to the factory reset values go to: Menu->Setup -> Factory Reset-> press Enter to confirm	
IP Address:	192.168.1.39
Subnet mask:	255.255.0.0
Default gateway:	192.168.0.1
TCP Port #:	5000
UDP Port #:	50000
Default username:	Admin
Default password:	Admin
Factory Reset	
OSD	Go to: Menu > Factory > select either Reset (full reset) or a Soft Reset (reset device information excluding Ethernet parameters).
Front panel buttons	Press the Reset to XGA/1080p Button while plugging the power to reset the machine.
Embedded web pages	Device Settings > Soft Factory Reset.

Default EDID

Monitor

HDMI input

Monitor

Model name..... VP-427X1
 Manufacturer..... KMR
 Plug and Play ID..... KMR061D
 Serial number..... 49
 Manufacture date..... 2018, ISO week 6
 Filter driver..... None

 EDID revision..... 1.3
 Input signal type..... Digital
 Color bit depth..... Undefined
 Display type..... Monochrome/grayscale
 Screen size..... 310 x 170 mm (13.9 in)
 Power management..... Standby, Suspend
 Extension blocs..... 1 (CEA/CTA-EXT)

 DDC/CI..... n/a

Color characteristics

Default color space..... Non-sRGB
 Display gamma..... 2.40
 Red chromaticity..... Rx 0.611 - Ry 0.329
 Green chromaticity..... Gx 0.313 - Gy 0.559
 Blue chromaticity..... Bx 0.148 - By 0.131
 White point (default).... Wx 0.320 - Wy 0.336
 Additional descriptors... None

Timing characteristics

Horizontal scan range.... 15-136kHz
 Vertical scan range..... 23-61Hz
 Video bandwidth..... 600MHz
 CVT standard..... Not supported
 GTF standard..... Not supported
 Additional descriptors... None
 Preferred timing..... Yes
 Native/preferred timing.. 3840x2160p at 60Hz (16:9)

Modeline..... "3840x2160" 594.000 3840 4016 4104 4400 2160 2168 2178 2250 +hsync +vsync
 Detailed timing #1..... 1920x1080p at 60Hz (16:9)
 Modeline..... "1920x1080" 148.500 1920 2008 2052 2200 1080 1084 1089 1125 +hsync +vsync

Standard timings supported

640 x 480p at 60Hz - IBM VGA
 640 x 480p at 72Hz - VESA
 640 x 480p at 75Hz - VESA
 800 x 600p at 56Hz - VESA
 800 x 600p at 60Hz - VESA
 800 x 600p at 72Hz - VESA
 800 x 600p at 75Hz - VESA
 1024 x 768p at 60Hz - VESA
 1024 x 768p at 70Hz - VESA
 1024 x 768p at 75Hz - VESA
 1280 x 1024p at 75Hz - VESA
 1600 x 1200p at 60Hz - VESA STD
 1280 x 1024p at 60Hz - VESA STD
 1400 x 1050p at 60Hz - VESA STD
 1920 x 1080p at 60Hz - VESA STD
 640 x 480p at 85Hz - VESA STD
 800 x 600p at 85Hz - VESA STD
 1024 x 768p at 85Hz - VESA STD
 1280 x 1024p at 85Hz - VESA STD

EIA/CEA/CTA-861 Information

Revision number..... 3
 IT underscan..... Supported
 Basic audio..... Supported
 YCbCr 4:4:4..... Supported
 YCbCr 4:2:2..... Supported
 Native formats..... 0
 Detailed timing #1..... 1440x900p at 60Hz (16:10)
 Modeline..... "1440x900" 106.500 1440 1520 1672 1904 900 903 909 934 -hsync +vsync
 Detailed timing #2..... 1366x768p at 60Hz (16:9)
 Modeline..... "1366x768" 85.500 1366 1436 1579 1792 768 771 774 798 +hsync +vsync
 Detailed timing #3..... 1920x1200p at 60Hz (16:10)
 Modeline..... "1920x1200" 154.000 1920 1968 2000 2080 1200 1203 1209 1235 +hsync -vsync

CE video identifiers (VICs) - timing/formats supported

1920 x 1080p at 60Hz - HDTV (16:9, 1:1)
 1920 x 1080p at 50Hz - HDTV (16:9, 1:1)
 1280 x 720p at 60Hz - HDTV (16:9, 1:1)
 1280 x 720p at 50Hz - HDTV (16:9, 1:1)
 1920 x 1080i at 60Hz - HDTV (16:9, 1:1)
 1920 x 1080i at 50Hz - HDTV (16:9, 1:1)
 720 x 480p at 60Hz - EDTV (4:3, 8:9)
 720 x 576p at 50Hz - EDTV (4:3, 16:15)
 720 x 480i at 60Hz - Doublescan (4:3, 8:9)
 720 x 576i at 50Hz - Doublescan (4:3, 16:15)
 1920 x 1080p at 30Hz - HDTV (16:9, 1:1)
 1920 x 1080p at 25Hz - HDTV (16:9, 1:1)
 1920 x 1080p at 24Hz - HDTV (16:9, 1:1)
 1920 x 1080p at 24Hz - HDTV (16:9, 1:1)
 1920 x 1080p at 24Hz - HDTV (16:9, 1:1)
 1920 x 1080p at 24Hz - HDTV (16:9, 1:1)
 1920 x 1080p at 24Hz - HDTV (16:9, 1:1)
 1920 x 1080p at 24Hz - HDTV (16:9, 1:1)
 NB: NTSC refresh rate = (Hz*1000)/1001

CE audio data (formats supported)

LPCM 2-channel, 16/20/24 bit depths at 32/44/48 kHz

CE speaker allocation data

Channel configuration.... 2.0
 Front left/right..... Yes
 Front LFE..... No
 Front center..... No
 Rear left/right..... No
 Rear center..... No
 Front left/right center.. No
 Rear left/right center... No
 Rear LFE..... No

CE vendor specific data (VSDB)

IEEE registration number. 0x000C03
 CEC physical address.... 1.0.0.0
 Supports AI (ACP, ISRC).. No
 Supports 48bpp..... Yes
 Supports 36bpp..... Yes
 Supports 30bpp..... Yes
 Supports YCbCr 4:4:4..... Yes
 Supports dual-link DVI... No

Maximum TMDS clock..... 300MHz
 Audio/video latency (p).. n/a
 Audio/video latency (i).. n/a
 HDMI video capabilities.. Yes
 EDID screen size..... No additional info
 3D formats supported..... Not supported
 Data payload..... 030C001000783C20008001020304

CE vendor specific data (VSDB)
 IEEE registration number. 0xC45DD8
 CEC physical address..... 0.1.7.8
 Supports AI (ACP, ISRC).. Yes
 Supports 48bpp..... No
 Supports 36bpp..... No
 Supports 30bpp..... No
 Supports YCbCr 4:4:4..... No
 Supports dual-link DVI... No
 Maximum TMDS clock..... 35MHz

YCbCr 4:2:0 capability map data
 Data payload..... 0F000003

HDBT inputs

Monitor

Model name..... VP-427X1
 Manufacturer..... KMR
 Plug and Play ID..... KMR041D
 Serial number..... 49
 Manufacture date..... 2018, ISO week 6
 Filter driver..... None

 EDID revision..... 1.3
 Input signal type..... Digital
 Color bit depth..... Undefined
 Display type..... RGB color
 Screen size..... 310 x 170 mm (13.9 in)
 Power management..... Standby, Suspend
 Extension blocs..... 1 (CEA/CTA-EXT)

 DDC/CI..... n/a

Color characteristics

Default color space..... Non-sRGB
 Display gamma..... 2.40
 Red chromaticity..... Rx 0.611 - Ry 0.329
 Green chromaticity..... Gx 0.313 - Gy 0.559
 Blue chromaticity..... Bx 0.148 - By 0.131
 White point (default)... Wx 0.320 - Wy 0.336
 Additional descriptors... None

Timing characteristics

Horizontal scan range.... 15-136kHz
 Vertical scan range..... 23-61Hz
 Video bandwidth..... 300MHz
 CVT standard..... Not supported
 GTF standard..... Not supported
 Additional descriptors... None
 Preferred timing..... Yes
 Native/preferred timing.. 3840x2160p at 30Hz (16:9)
 Modeline..... "3840x2160" 297.000 3840 4016 4104 4400 2160 2168 2178 2250 +hsync +vsync
 Detailed timing #1..... 1920x1080p at 60Hz (16:9)
 Modeline..... "1920x1080" 148.500 1920 2008 2052 2200 1080 1084 1089 1125 +hsync +vsync

Standard timings supported

640 x 480p at 60Hz - IBM VGA
 640 x 480p at 72Hz - VESA
 640 x 480p at 75Hz - VESA
 800 x 600p at 56Hz - VESA
 800 x 600p at 60Hz - VESA
 800 x 600p at 72Hz - VESA
 800 x 600p at 75Hz - VESA
 1024 x 768p at 60Hz - VESA
 1024 x 768p at 70Hz - VESA
 1024 x 768p at 75Hz - VESA
 1280 x 1024p at 75Hz - VESA
 1600 x 1200p at 60Hz - VESA STD
 1280 x 1024p at 60Hz - VESA STD
 1400 x 1050p at 60Hz - VESA STD
 1920 x 1080p at 60Hz - VESA STD

640 x 480p at 85Hz - VESA STD
 800 x 600p at 85Hz - VESA STD
 1024 x 768p at 85Hz - VESA STD
 1280 x 1024p at 85Hz - VESA STD

EIA/CEA/CTA-861 Information

Revision number..... 3
 IT underscan..... Supported
 Basic audio..... Supported
 YCbCr 4:4:4..... Supported
 YCbCr 4:2:2..... Supported
 Native formats..... 0
 Detailed timing #1..... 1440x900p at 60Hz (16:10)
 Modeline..... "1440x900" 106.500 1440 1520 1672 1904 900 903 909 934 -hsync +vsync
 Detailed timing #2..... 1366x768p at 60Hz (16:9)
 Modeline..... "1366x768" 85.500 1366 1436 1579 1792 768 771 774 798 +hsync +vsync
 Detailed timing #3..... 1920x1200p at 60Hz (16:10)
 Modeline..... "1920x1200" 154.000 1920 1968 2000 2080 1200 1203 1209 1235 +hsync -vsync

CE video identifiers (VICs) - timing/formats supported

1920 x 1080p at 60Hz - HDTV (16:9, 1:1)
 1920 x 1080p at 50Hz - HDTV (16:9, 1:1)
 1280 x 720p at 60Hz - HDTV (16:9, 1:1)
 1280 x 720p at 50Hz - HDTV (16:9, 1:1)
 1920 x 1080i at 60Hz - HDTV (16:9, 1:1)
 1920 x 1080i at 50Hz - HDTV (16:9, 1:1)
 720 x 480p at 60Hz - EDTV (4:3, 8:9)
 720 x 576p at 50Hz - EDTV (4:3, 16:15)
 720 x 480i at 60Hz - Doublescan (4:3, 8:9)
 720 x 576i at 50Hz - Doublescan (4:3, 16:15)
 1920 x 1080p at 30Hz - HDTV (16:9, 1:1)
 1920 x 1080p at 25Hz - HDTV (16:9, 1:1)
 1920 x 1080p at 24Hz - HDTV (16:9, 1:1)
 1920 x 1080p at 24Hz - HDTV (16:9, 1:1)
 1920 x 1080p at 24Hz - HDTV (16:9, 1:1)
 1920 x 1080p at 24Hz - HDTV (16:9, 1:1)
 NB: NTSC refresh rate = (Hz*1000)/1001

CE audio data (formats supported)

LPCM 2-channel, 16/20/24 bit depths at 32/44/48 kHz

CE speaker allocation data

Channel configuration.... 2.0
 Front left/right..... Yes
 Front LFE..... No
 Front center..... No
 Rear left/right..... No
 Rear center..... No
 Front left/right center.. No
 Rear left/right center... No
 Rear LFE..... No

CE vendor specific data (VSDB)

IEEE registration number. 0x000C03
 CEC physical address.... 1.0.0.0
 Supports AI (ACP, ISRC).. No
 Supports 48bpp..... Yes
 Supports 36bpp..... Yes
 Supports 30bpp..... Yes
 Supports YCbCr 4:4:4..... Yes
 Supports dual-link DVI... No
 Maximum TMDS clock..... 300MHz
 Audio/video latency (p).. n/a
 Audio/video latency (i).. n/a
 HDMI video capabilities.. Yes
 EDID screen size..... No additional info
 3D formats supported.... Not supported
 Data payload..... 030C001000783C20008001020304

Protocol 3000

Kramer devices can be operated using Kramer Protocol 3000 commands sent via serial or Ethernet ports.

Understanding Protocol 3000

Protocol 3000 commands are a sequence of ASCII letters, structured according to the following.

- **Command format:**

Prefix	Command Name	Constant (Space)	Parameter(s)	Suffix
#	Command	-	Parameter	<CR>

- **Feedback format:**



Prefix	Device ID	Constant	Command Name	Parameter(s)	Suffix
~	nn	@	Command	Parameter	<CR><LF>

- **Command parameters** – Multiple parameters must be separated by a comma (,). In addition, multiple parameters can be grouped as a single parameter using brackets ([and]).
- **Command chain separator character** – Multiple commands can be chained in the same string. Each command is delimited by a pipe character (|).
- **Parameters attributes** – Parameters may contain multiple attributes. Attributes are indicated with pointy brackets (<...>) and must be separated by a period (.).

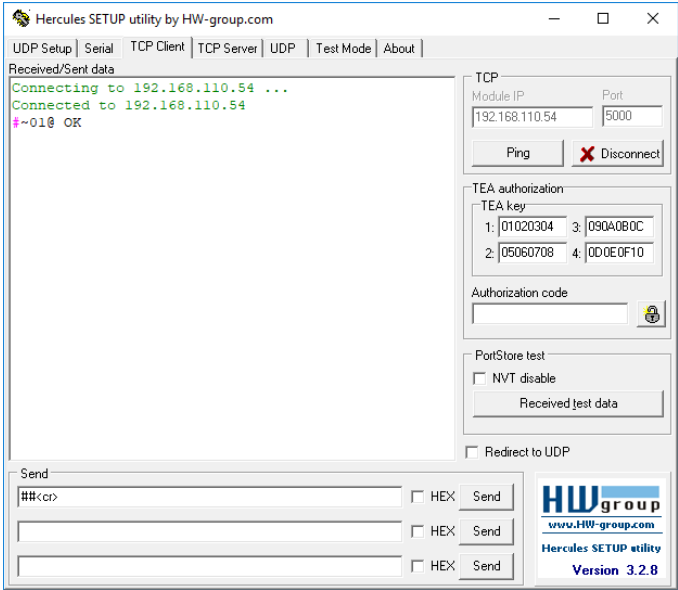
The command framing varies according to how you interface with **VP-427X1**. The following figure displays how the # command is framed using terminal communication software (such as Hercules):



Protocol 3000 Commands

Function	Description	Syntax	Parameters/Attributes	Example
#	Protocol handshaking.  Validates the Protocol 3000 connection and gets the machine number. Step-in master products use this command to identify the availability of a device.	COMMAND #<CR> FEEDBACK ~nn@_ok<CR><LF>		#<CR>
AUD-LVL	Set volume level.	COMMAND #AUD-LVL_ <u>io_mode</u> , <u>io_index</u> , <u>vol_level</u> <CR> FEEDBACK ~nn@AUD-LVL_ <u>io_mode</u> , <u>io_index</u> , <u>vol_level</u> <CR><LF>	<u>io_mode</u> – 1 – Output <u>io_index</u> – 0 <u>vol_level</u> – Volume level 0 to 100; ++ (increase current value by 1); -- (decrease current value by 1)	Set audio output level to 50: #AUD-LVL_1,0,50<CR>
AUD-LVL?	Get volume level.	COMMAND #AUD-LVL?_ <u>io_mode</u> , <u>io_index</u> <CR> FEEDBACK ~nn@AUD-LVL_ <u>io_mode</u> , <u>io_index</u> , <u>vol_level</u> <CR><LF>	<u>io_mode</u> – 1 – Output <u>io_index</u> – 0 <u>vol_level</u> – Volume level 0 to 100; ++ (increase current value by 1); -- (decrease current value by 1)	Get audio output level #AUD-LVL?_1,0<CR>
AV-SW-MODE	Set input auto switch mode (per output).	COMMAND #AV-SW-MODE_ <u>layer_type</u> , <u>out_index</u> , <u>connection_mode</u> <CR> FEEDBACK ~nn@AV-SW-MODE_ <u>layer_type</u> , <u>out_index</u> , <u>connection_mode</u> <CR><LF>	<u>layer_type</u> – Number that indicates the signal type: 1 – Audio+Video <u>out_index</u> – 1 <u>connection_mode</u> – Connection mode 0 – manual 1 – priority switch 2 – last connected switch	Set input auto switch mode to manual: #AV-SW-MODE_1,1,0<CR>
AV-SW-MODE?	Get input auto switch mode (per output).	COMMAND #AV-SW-MODE?_ <u>layer_type</u> , <u>out_index</u> <CR> FEEDBACK ~nn@AV-SW-MODE_ <u>layer_type</u> , <u>out_index</u> , <u>connection_mode</u> <CR><LF>	<u>layer_type</u> – Number that indicates the signal type: 1 – Audio+Video <u>out_index</u> – 1 <u>connection_mode</u> – Connection mode 0 – manual 1 – priority switch 2 – last connected switch	Get the input audio switch mode: #AV-SW-MODE?_1,1<CR>
BUILD-DATE?	Get device build date.	COMMAND #BUILD-DATE?_ <u>date</u> <CR> FEEDBACK ~nn@BUILD-DATE_ <u>date</u> , <u>time</u> <CR><LF>	<u>date</u> – Format: YYYY/MM/DD where YYYY = Year MM = Month DD = Day <u>time</u> – Format: hh:mm:ss where hh = hours mm = minutes ss = seconds	Get the device build date: #BUILD-DATE?<CR>
CEC	Set display to ON/OFF	COMMAND #CEC_ <u>state</u> <CR> FEEDBACK ~nn@CEC_ <u>state</u> <CR><LF>	<u>state</u> – CEC state Off On	Set display to OFF via CEC: #CEC OFF<CR>
CEC-PASS	Set CEC device bypass.	COMMAND #CEC-PASS_ <u>state</u> <CR> FEEDBACK ~nn@CEC-PASS_ <u>state</u> <CR><LF>	<u>state</u> – CEC state 0 – Off 1 – On	Set bypass device state: #CEC-PASS_1<CR>
CEC-PASS?	Get CEC device bypass state.	COMMAND #CEC-PASS?_ <u>state</u> <CR> FEEDBACK ~nn@CEC-PASS_ <u>state</u> <CR><LF>	<u>state</u> – CEC state 0 – Off 1 – On	Get bypass device state: #CEC-PASS?_<CR>
CPEDID	Copy EDID data from the output to the input EEPROM.  Destination bitmap size depends on device properties (for 64 inputs it is a 64-bit word). Example: bitmap 0x0013 means inputs 1,2 and 5 are loaded with the new EDID. In certain products Safe_mode is an optional parameter. See the HELP command for its availability.	COMMAND #CPEDID_ <u>edid_io</u> , <u>src_id</u> , <u>edid_io</u> , <u>dest_bitmap</u> <CR> or #CPEDID_ <u>edid_io</u> , <u>src_id</u> , <u>edid_io</u> , <u>dest_bitmap</u> , <u>safe_mode</u> <CR> FEEDBACK ~nn@CPEDID_ <u>edid_io</u> , <u>src_id</u> , <u>edid_io</u> , <u>dest_bitmap</u> <CR><LF> ~nn@CPEDID_ <u>edid_io</u> , <u>src_id</u> , <u>edid_io</u> , <u>dest_bitmap</u> , <u>safe_mode</u> <CR><LF>	<u>edid_io</u> – EDID source type (usually output) 1 – Output <u>src_id</u> – Number of chosen source stage 1 – HDMI <u>edid_io</u> – EDID destination type (usually input) 0 – Input <u>dest_bitmap</u> – Bitmap representing destination IDs. 0x01 – HDBT 0x02 – HDMI 0 – indicates that EDID data is not copied to this destination. 1 – indicates that EDID data is copied to this destination. <u>safe_mode</u> – Safe mode 0 – device accepts the EDID as is without trying to adjust 1 – device tries to adjust the EDID (default value if no parameter is sent)	Copy the EDID data from the Output (EDID source) to the HDBT input: #CPEDID_1,1,0,0x01<CR>

Function	Description	Syntax	Parameters/Attributes	Example
DISPLAY?	Get output HPD status.	COMMAND #DISPLAY?_out_index<CR> FEEDBACK ~nn@DISPLAY_out_index,status<CR><LF>	out_index – 1 status – HPD status according to signal validation 0 – Signal or sink is not valid 1 – Signal or sink is valid 2 – Sink and EDID is valid	Get the output HPD status of the output: #DISPLAY?_1<CR>
ETH-PORT	Set Ethernet port protocol. ⓘ If the port number you enter is already in use, an error is returned. The port number must be within the following range: 0-(2^16-1).	COMMAND #ETH-PORT_port_type,port_id<CR> FEEDBACK ~nn@ETH-PORT_port_type,port_id<CR><LF>	port_type – TCP/UDP port_id – TCP/UDP port number (0 – 65535)	Set the Ethernet port protocol for TCP to port 12457: #ETH-PORT_0,12457<CR>
ETH-PORT?	Get Ethernet port protocol.	COMMAND #ETH-PORT?_port_type<CR> FEEDBACK ~nn@ETH-PORT_port_type,port_id<CR><LF>	port_type – TCP/UDP 0 – TCP 1 – UDP port_id – TCP / UDP port number (0 – 65535)	Get the Ethernet port protocol for UDP: #ETH-PORT?_1<CR>
FACTORY	Reset device to factory default configuration. ⓘ This command deletes all user data from the device. The deletion can take some time. Your device may require powering off and powering on for the changes to take effect.	COMMAND #FACTORY<CR> FEEDBACK ~nn@FACTORY_ok<CR><LF>		Reset the device to factory default configuration: #FACTORY<CR>
HDCP-MOD	Set HDCP mode. ⓘ Set HDCP working mode on the device input: HDCP supported - HDCP_ON [default]. HDCP not supported - HDCP OFF. HDCP support changes following detected sink - MIRROR OUTPUT. When you define 3 as the mode, the HDCP status is defined according to the connected output in the following priority: OUT 1, OUT 2. If the connected display on OUT 2 supports HDCP, but OUT 1 does not, then HDCP is defined as not supported. If OUT 1 is not connected, then HDCP is defined by OUT 2.	COMMAND #HDCP-MOD_io_stage,io_index,mode<CR> FEEDBACK ~nn@HDCP-MOD_io_stage,io_index,mode<CR><LF>	io_mode, 0 – Input 1 – Output io_index – For inputs: 1 – HDBT 2 – HDMI For input: 1 mode – HDCP mode: for inputs 0 – HDCP Off 1 – HDCP On For output 2 – Follow Input 3 – Follow output (HDCP defined according to the connected output)	Set the input HDCP-MODE of HDBT to Off: #HDCP-MOD_0,1,0<CR>
HDCP-MOD?	Get HDCP mode. ⓘ Set HDCP working mode on the device input: HDCP supported - HDCP_ON [default]. HDCP not supported - HDCP OFF. HDCP support changes following detected sink - MIRROR OUTPUT.	COMMAND #HDCP-MOD?_io_stage,io_index<CR> FEEDBACK ~nn@HDCP-MOD_iiio_stage,io_index,mode<CR><LF>	io_mode, 0 – Input 1 – Output io_index – For inputs: 1 – HDBT 2 – HDMI For input: 1 mode – HDCP mode: for inputs 0 – HDCP Off 1 – HDCP On For output 2 – Follow Input 3 – Follow output (HDCP defined according to the connected output)	Get the input HDCP-MODE of HDMI: #HDCP-MOD?_0,2<CR>
HELP	Get command list or help for specific command.	COMMAND #HELP<CR> #HELP_cmd_name<CR> FEEDBACK 1. Multi-line: ~nn@Device_cmd_name,_cmd_name...<CR><LF> To get help for command use: HELP (COMMAND_NAME)<CR><LF> ~nn@HELP_cmd_name:<CR><LF> description<CR><LF> USAGE: usage<CR><LF>	cmd_name – Name of a specific command	Get the command list: #HELP<CR> To get help for AV-SW-TIMEOUT: HELP_av-sw-timeout<CR>

Function	Description	Syntax	Parameters/Attributes	Example
IMAGE-PROP	Set the image size. ① Sets the image properties of the selected scaler.	COMMAND #IMAGE-PROP,scaler_id<CR> FEEDBACK ~nn@IMAGE-PROP,scaler_id,video_mode...<CR><LF>	scaler_id – Scaler number – 1 video_mode – Status 0 – Over scan 1 – Full 2 – Best fit 3 – Pan scan 4 – Letter box 5 – Under 2 6 – Under 1 7 – Follow in	Set the image size to Full: #IMAGE-PROP,1,1<CR>
IMAGE-PROP?	Get the image size. ① Gets the image properties of the selected scaler.	COMMAND #IMAGE-PROP?,scaler_id<CR> FEEDBACK ~nn@IMAGE-PROP,scaler_id,video_mode...<CR><LF>	scaler_id – Scaler number – 1 video_mode – Status 0 – Over scan 1 – Full 2 – Best fit 3 – Pan scan 4 – Letter box 5 – Under 2 6 – Under 1 7 – Follow in	Get the image size: #IMAGE-PROP?,1,1<CR>
MODEL?	Get device model. ① This command identifies equipment connected to VP-427X1 and notifies of identity changes to the connected equipment. The Matrix saves this data in memory to answer REMOTE-INFO requests.	COMMAND #MODEL?,<CR> FEEDBACK ~nn@MODEL,model_name<CR><LF>	model_name – String of up to 19 printable ASCII chars	Get the device model: #MODEL?,<CR>
MUTE	Set audio mute.	COMMAND #MUTE,out_index,mute_mode<CR> FEEDBACK ~nn@MUTE,out_index,mute_mode<CR><LF>	out_index – 1 mute_mode – On/Off 0 – Off 1 – On	Set output to mute: #MUTE,1,1<CR>
MUTE?	Get audio mute.	COMMAND #MUTE?,out_index<CR> FEEDBACK ~nn@MUTE,out_index,mute_mode<CR><LF>	out_index – 1 mute_mode – On/Off 0 – Off 1 – On	Get mute status of output: #MUTE?,1,1<CR>
NAME	Set machine (DNS) name. ① The machine name is not the same as the model name. The machine name is used to identify a specific machine or a network in use (with DNS feature on).	COMMAND #NAME,machine_name<CR> FEEDBACK ~nn@NAME,machine_name<CR><LF>	machine_name – String of up to 15 alpha-numeric chars (can include hyphen, not at the beginning or end)	Set the DNS name of the device to room-442: #NAME,room-442<CR>
NAME?	Get machine (DNS) name. ① The machine name is not the same as the model name. The machine name is used to identify a specific machine or a network in use (with DNS feature on).	COMMAND #NAME?,<CR> FEEDBACK ~nn@NAME,machine_name<CR><LF>	machine_name – String of up to 15 alpha-numeric chars (can include hyphen, not at the beginning or end)	Get the DNS name of the device: #NAME?,<CR>
NAME-RST	Reset machine (DNS) name to factory default. ① Factory default of machine (DNS) name is "KRAME" + 4 last digits of device serial number.	COMMAND #NAME-RST<CR> FEEDBACK ~nn@NAME-RST,ok<CR><LF>		Reset the machine name (S/N last digits are 0102): #NAME-RST,kramer_0102<CR>

Function	Description	Syntax	Parameters/Attributes	Example
NET-DHCP	<p>Set DHCP mode.</p> <p>i Only 1 is relevant for the mode value. To disable DHCP, the user must configure a static IP address for the device.</p> <p>Connecting Ethernet to devices with DHCP may take more time in some networks.</p> <p>To connect with a randomly assigned IP by DHCP, specify the device DNS name (if available) using the NAME command. You can also get an assigned IP by direct connection to USB or RS-232 protocol port, if available.</p> <p>For proper settings consult your network administrator.</p>	<p>COMMAND</p> <pre>#NET-DHCP_dhcp_state<CR></pre> <p>FEEDBACK</p> <pre>~nn@NET-DHCP_dhcp_state<CR><LF></pre>	<p>dhcp_state –</p> <p>0 – Static IP</p> <p>1 – DHCP</p>	<p>Enable DHCP mode:</p> <pre>#NET-DHCP_1<CR></pre>
NET-DHCP?	Get DHCP mode.	<p>COMMAND</p> <pre>#NET-DHCP?_<CR></pre> <p>FEEDBACK</p> <pre>~nn@NET-DHCP_dhcp_mode<CR><LF></pre>	<p>dhcp_state –</p> <p>0 – Static IP</p> <p>1 – DHCP</p>	<p>Get DHCP mode:</p> <pre>#NET-DHCP?_<CR></pre>
NET-GATE	<p>Set gateway IP.</p> <p>i A network gateway connects the device via another network and maybe over the Internet. Be careful of security issues. For proper settings consult your network administrator.</p>	<p>COMMAND</p> <pre>#NET-GATE_ip_address<CR></pre> <p>FEEDBACK</p> <pre>~nn@NET-GATE_ip_address<CR><LF></pre>	<p>ip_address – Format:</p> <p>xxx.xxx.xxx.xxx</p>	<p>Set the gateway IP address to 192.168.0.1:</p> <pre>#NET-GATE_192.168.0.001<CR></pre>
NET-GATE?	<p>Get gateway IP.</p> <p>i A network gateway connects the device via another network and maybe over the Internet. Be aware of security problems.</p>	<p>COMMAND</p> <pre>#NET-GATE?_<CR></pre> <p>FEEDBACK</p> <pre>~nn@NET-GATE_ip_address<CR><LF></pre>	<p>ip_address – Format:</p> <p>xxx.xxx.xxx.xxx</p>	<p>Get the gateway IP address:</p> <pre>#NET-GATE?_<CR></pre>
NET-IP	<p>Set IP address.</p> <p>i For proper settings consult your network administrator.</p>	<p>COMMAND</p> <pre>#NET-IP_ip_address<CR></pre> <p>FEEDBACK</p> <pre>~nn@NET-IP_ip_address<CR><LF></pre>	<p>ip_address – Format:</p> <p>xxx.xxx.xxx.xxx</p>	<p>Set the IP address to 192.168.1.39:</p> <pre>#NET-IP_192.168.001.039<CR></pre>
NET-IP?	Get IP address.	<p>COMMAND</p> <pre>#NET-IP?_<CR></pre> <p>FEEDBACK</p> <pre>~nn@NET-IP_ip_address<CR><LF></pre>	<p>ip_address – Format:</p> <p>xxx.xxx.xxx.xxx</p>	<p>Get the IP address:</p> <pre>#NET-IP?_<CR></pre>
NET-MAC?	<p>Get MAC address.</p> <p>i For backward compatibility, the id parameter can be omitted. In this case, the Network ID, by default, is 0, which is the Ethernet control port.</p>	<p>COMMAND</p> <pre>#NET-MAC?_id<CR></pre> <p>FEEDBACK</p> <pre>~nn@NET-MAC_id,mac_address<CR><LF></pre>	<p>id – Network ID—the device network interface (if there are more than one). Counting is 0 based, meaning the control port is '0', additional ports are 1,2,3....</p> <p>mac_address – Unique MAC address. Format: XX-XX-XX-XX-XX-XX where X is hex digit</p>	<pre>#NET-MAC?_id<CR></pre>
NET-MASK	<p>Set subnet mask.</p> <p>i For proper settings consult your network administrator.</p>	<p>COMMAND</p> <pre>#NET-MASK_net_mask<CR></pre> <p>FEEDBACK</p> <pre>~nn@NET-MASK_net_mask<CR><LF></pre>	<p>net_mask – Format:</p> <p>xxx.xxx.xxx.xxx</p>	<p>Set the subnet mask to 255.255.0.0:</p> <pre>#NET-MASK_255.255.000.000<CR></pre>
NET-MASK?	Get subnet mask.	<p>COMMAND</p> <pre>#NET-MASK?_<CR></pre> <p>FEEDBACK</p> <pre>~nn@NET-MASK_net_mask<CR><LF></pre>	<p>net_mask – Format:</p> <p>xxx.xxx.xxx.xxx</p>	<p>Get the subnet mask:</p> <pre>#NET-MASK?_<CR></pre>
PROT-VER?	Get device protocol version.	<p>COMMAND</p> <pre>#PROT-VER?_<CR></pre> <p>FEEDBACK</p> <pre>~nn@PROT-VER_3000:version<CR><LF></pre>	<p>version – XX.XX where X is a decimal digit</p>	<p>Get the device protocol version:</p> <pre>#PROT-VER?_<CR></pre>
RESET	<p>Reset device.</p> <p>i To avoid locking the port due to a USB bug in Windows, disconnect USB connections immediately after running this command. If the port was locked, disconnect and reconnect the cable to reopen the port.</p>	<p>COMMAND</p> <pre>#RESET<CR></pre> <p>FEEDBACK</p> <pre>~nn@RESET_ok<CR><LF></pre>		<p>Reset the device:</p> <pre>#RESET<CR></pre>

Function	Description	Syntax	Parameters/Attributes	Example
ROUTE	Set layer routing. ⓘ This command replaces all other routing commands.	COMMAND #ROUTE_<layer_type>,<out_index>,<in_index><CR> FEEDBACK ~nn@ROUTE_<layer_type>,<out_index>,<in_index><CR><LF>	layer_type Layer Enumeration 1 – Video+Audio out_index 1 in_index – Source id 1 – HDBT 2 – HDMI	Route video HDMI to output: #ROUTE_1,1,2<CR>
ROUTE?	Get layer routing. ⓘ This command replaces all other routing commands.	COMMAND #ROUTE?_<layer_type>,<out_index><CR> FEEDBACK ~nn@ROUTE_<layer_type>,<out_index>,<in_index><CR><LF>	layer_type Layer Enumeration 1 – Video+Audio out_index 1 in_index – Source id 1 – HDBT 2 – HDMI	Get the layer routing: #ROUTE?_1,1<CR>
SCLR-AS	Set auto-sync features. ⓘ Sets the auto sync features for the selected scaler.	COMMAND #SCLR-AS_<scaler_index>,<sync_speed><CR> FEEDBACK ~nn@SCLR-AS_<scaler_index>,<sync_speed><CR><LF>	scaler_index – 1 sync_speed – 0, 1 or 2 0 – off 1 – fast 2 – slow 3 – immediate	Set auto-sync off to immediate: #SCLR-AS_1,3<CR>
SCLR-AS?	Get auto-sync features. ⓘ Gets the auto sync features for the selected scaler.	COMMAND #SCLR-AS?_<scaler_index><CR> FEEDBACK ~nn@SCLR-AS_<scaler_index>,<sync_speed><CR><LF>	scaler_index – 1 sync_speed – 0, 1 or 2 0 – off 1 – fast 2 – slow 3 – immediate	Get auto-sync features: #SCLR-AS?_1<CR>
SCLR-AUDIO-DELAY	Set the scaler audio delay. ⓘ Sets the audio delay for the selected audio output.	COMMAND #SCLR-AUDIO-DELAY_<scaler_index>,<delay><CR> FEEDBACK ~nn@SCLR-AUDIO-DELAY_<scaler_index>,<delay><CR><LF>	scaler_index – 1 delay – 0 – Off 1 – 40ms 2 – 110ms 3 – 150ms	Set the scaler audio delay to 40ms: #SCLR-AUDIO-DELAY_1,1<CR>
SCLR-AUDIO-DELAY?	Get the scaler audio delay. ⓘ Gets the audio delay for the selected audio output.	COMMAND #SCLR-AUDIO-DELAY?_<scaler_index><CR> FEEDBACK ~nn@SCLR-AUDIO-DELAY_<scaler_index>,<delay><CR><LF>	scaler_index – 1 delay – 0 – Off 1 – 40ms 2 – 110ms 3 – 150ms	Get the scaler audio delay: #SCLR-AUDIO-DELAY?_1<CR>
SIGNAL?	Get input signal status.	COMMAND #SIGNAL?_<in_index><CR> FEEDBACK ~nn@SIGNAL_<in_index>,<status><CR><LF>	in_index – Number that indicates the specific input: 1 – HDBT 2 – HDMI status – Signal status according to signal validation: 0 – Off 1 – On	Get the input signal lock status of HDBT: #SIGNAL?_1<CR>
SN?	Get device serial number.	COMMAND #SN?_<CR> FEEDBACK ~nn@SN_<serial_num><CR><LF>	serial_num – 14 decimal digits, factory assigned	Get the device serial number: #SN?_<CR>
VERSION?	Get firmware version number.	COMMAND #VERSION?_<CR> FEEDBACK ~nn@VERSION_<firmware_version><CR><LF>	firmware_version – XX.XX.XXXX where the digit groups are: major.minor.build version	Get the device firmware version number: #VERSION?_<CR>
VFRZ	Set freeze on selected output.	COMMAND #VFRZ_<out_index>,<freeze_flag><CR> FEEDBACK ~nn@VFRZ_<out_index>,<freeze_flag><CR><LF>	out_index – 1 freeze_flag – On/Off 0 – Off 1 – On	Set freeze on selected output: #VFRZ_1,1<CR>
VFRZ?	Get output freeze status.	COMMAND #VFRZ?_<out_index><CR> FEEDBACK ~nn@VFRZ_<out_index>,<freeze_flag><CR><LF>	out_index – 1 freeze_flag – On/Off 0 – Off 1 – On	Get output freeze status: #VFRZ?_1<CR>

Function	Description	Syntax	Parameters/Attributes	Example
VID-RES	<p>Set output resolution.</p> <p>ⓘ "Set" command with is_native=ON sets native resolution on selected output (resolution index sent = 0). Device sends as answer actual VIC ID of native resolution.</p> <p>To use "custom resolutions" (entries 100-105 In View Modes), define them using the DEF-RES command.</p>	<p>COMMAND</p> <pre>#VID-RES,io_mode,io_index,is_native,resolution<CR></pre> <p>FEEDBACK</p> <pre>~nn@VID-RES,io_mode,io_index,is_native,resolution<CR><LF></pre>	<p>io_mode – Output</p> <p>1 – Output</p> <p>io_index – 1</p> <p>is_native – Native resolution flag</p> <p>0 – Off</p> <p>resolution – Resolution index</p> <p>200= Native</p> <p>201=640x480</p> <p>202= 800x600</p> <p>203=1024x768</p> <p>204=1280x768</p> <p>205=1360x768</p> <p>206=1280x720</p> <p>207=1280x800</p> <p>208=1280x1024</p> <p>209=1440x900</p> <p>210=1400x1050</p> <p>211=1680x1050</p> <p>212=1600x1200</p> <p>213=1920x1080</p> <p>214=1920x1200</p> <p>215=2560x1600</p> <p>216=2560x1440</p> <p>217=480p</p> <p>218=576p</p> <p>219=720p50</p> <p>220=720p60</p> <p>221=1080p24</p> <p>222=1080p25</p> <p>223=1080p30</p> <p>224=1080p50</p> <p>225=1080p60</p> <p>226=4K24</p> <p>227=4K25</p> <p>228=4K30</p> <p>229=4K50</p> <p>230=4K60</p>	<p>Set output resolution:</p> <pre>#VID-RES,1,1,0,1<CR></pre>
VID-RES?	<p>Get output resolution.</p> <p>ⓘ "Get" command with is_native=ON returns native resolution VIC, with is_native=OFF returns current resolution.</p> <p>To use "custom resolutions" (entries 100-105 In View Modes), define them using the DEF-RES command.</p>	<p>COMMAND</p> <pre>#VID-RES?,io_mode,io_index,is_native<CR></pre> <p>FEEDBACK</p> <pre>~nn@VID-RES?,io_mode,io_index,is_native,resolution<CR><LF></pre>	<p>io_mode – Input/Output</p> <p>0 – Input</p> <p>1 – Output</p> <p>io_index – Number that indicates the specific input or output port:</p> <p>1-N (N= the total number of input or output ports)</p> <p>is_native – Native resolution flag</p> <p>0 – Off</p> <p>1 – On</p> <p>resolution – Resolution index</p> <p>io_mode – Output</p> <p>1 – Output</p> <p>io_index – 1</p> <p>is_native – Native resolution flag</p> <p>0 – Off</p> <p>resolution – Resolution index</p> <p>200= Native</p> <p>201=640x480</p> <p>202= 800x600</p> <p>203=1024x768</p> <p>204=1280x768</p> <p>205=1360x768</p> <p>206=1280x720</p> <p>207=1280x800</p> <p>208=1280x1024</p> <p>209=1440x900</p> <p>210=1400x1050</p> <p>211=1680x1050</p> <p>212=1600x1200</p> <p>213=1920x1080</p> <p>214=1920x1200</p> <p>215=2560x1600</p> <p>216=2560x1440</p> <p>217=480p</p> <p>218=576p</p> <p>219=720p50</p> <p>220=720p60</p> <p>221=1080p24</p> <p>222=1080p25</p> <p>223=1080p30</p> <p>224=1080p50</p> <p>225=1080p60</p> <p>226=4K24</p> <p>227=4K25</p> <p>228=4K30</p> <p>229=4K50</p> <p>230=4K60</p>	<p>Set output resolution:</p> <pre>#VID-RES?,1,1,1,1<CR></pre>
VMUTE	<p>Set enable/disable video on output.</p>	<p>COMMAND</p> <pre>#VMUTE,out_index,flag<CR></pre> <p>FEEDBACK</p> <pre>~nn@VMUTE,out_index,flag<CR><LF></pre>	<p>out_index – 1</p> <p>flag – Video Mute</p> <p>0 – Video enabled</p> <p>1 – Video disabled</p>	<p>Disable the video output on OUT 2:</p> <pre>#VMUTE,1,0<CR></pre>
VMUTE?	<p>Get video on output status.</p>	<p>COMMAND</p> <pre>#VMUTE?,out_index<CR></pre> <p>FEEDBACK</p> <pre>~nn@VMUTE,out_index,flag<CR><LF></pre>	<p>out_index – 1</p> <p>flag – Video Mute</p> <p>0 – Video enabled</p> <p>1 – Video disabled</p>	<p>Get video on output status:</p> <pre>#VMUTE?,1<CR></pre>

Function	Description	Syntax	Parameters/Attributes	Example
X-AUD-LVL	Set audio level of a specific signal. ⓘ This is an Extended Protocol 3000 command.	COMMAND #X-AUD-LVL<direction_type>. <port_format>. <port_index>.<signal_type>. <index>, audio_level<CR> FEEDBACK ~nn@X-AUD-LVL<direction_type>. <port_format>.<port_index>. <signal_type>. <index>, audio_level<CR><LF>	The following attributes comprise the signal ID: ▪ <direction_type> – Direction of the port: ○ OUT – Output ▪ <port_format> – Type of signal on the port: ○ HDMI ▪ <port_index> – 1 ▪ <signal_type> – Signal ID attribute: ○ AUDIO ▪ <index> – 1 audio_level – Audio level (range between 0 to 100) depending of the ability of the product	Set the audio level of HDMI output to 10: #X-AUD-LVL<u>OUT.HDMI.1.AUDIO.1,10<CR>
X-AUD-LVL?	Get audio level of a specific signal. ⓘ This is an Extended Protocol 3000 command.	COMMAND #X-AUD-LVL?<direction_type>. <port_format>. <port_index>.<signal_type>. <index><CR> FEEDBACK ~nn@X-AUD-LVL<direction_type>. <port_format>.<port_index>. <signal_type>. <index>, audio_level<CR><LF>	The following attributes comprise the signal ID: ▪ <direction_type> – Direction of the port: ○ OUT – Output ▪ <port_format> – Type of signal on the port: ○ HDMI ▪ <port_index> – 1 ▪ <signal_type> – Signal ID attribute: ○ AUDIO ▪ <index> – 1 audio_level – Audio level (range between 0 to 100) depending of the ability of the product	Get the audio level of HDMI output: #X-AUD-LVL?<u>OUT.HDMI.1.AUDIO.1<CR>
X-AV-SW-MODE	Set auto-switch mode per output. ⓘ This is an Extended Protocol 3000 command.	COMMAND #X-AV-SW-MODE<direction_type>. <port_format>.<port_index>. <signal_type>. <index>, connection_mode<CR> FEEDBACK ~nn@X-AV-SW-MODE<direction_type>. <port_format>.<port_index>. <signal_type>.<index>, connection_mode<CR><LF>	The following attributes comprise the signal ID: ▪ <direction_type> – Direction of the port: ○ OUT – Output ▪ <port_format> – Type of signal on the port: ○ HDMI ▪ <port_index> – 1 ▪ <signal_type> – Signal ID attribute: ○ VIDEO ▪ <index> – 1 connection_mode – Connecton mode 0 – manual 1 – Auto Scan 2 – last connected	Set auto switch mode for the output to last connected: #X-AV-SW-MODE<u>OUT.HDMI.1.VIDEO.1,2<CR>
X-AV-SW-MODE?	Get auto-switch mode. ⓘ This is an Extended Protocol 3000 command.	COMMAND #X-AV-SW-MODE?<direction_type>. <port_format>.<port_index>. <signal_type>. <index><CR> FEEDBACK ~nn@X-AV-SW-MODE<direction_type>. <port_format>.<port_index>. <signal_type>.<index>, connection_mode<CR><LF>	The following attributes comprise the signal ID: ▪ <direction_type> – Direction of the port: ○ OUT – Output ▪ <port_format> – Type of signal on the port: ○ HDMI ▪ <port_index> – 1 ▪ <signal_type> – Signal ID attribute: ○ VIDEO ▪ <index> – 1 connection_mode – Connecton mode 0 – manual 1 – Auto Scan 2 – last connected	Get auto switch mode for the output: #X-AV-SW-MODE?<u>OUT.HDMI.1.VIDEO.1<CR>
X-MUTE	Set mute ON/OFF on a specific signal. ⓘ This command is designed to Mute a Signal. This means that it could be applicable on any type of signal. Could be audio, video and maybe IR, USB or data if this capability is supported by the product. This is an Extended Protocol 3000 command.	COMMAND #X-MUTE<direction_type>. <port_format>. <port_index>.<signal_type>. <index>, state<CR> FEEDBACK ~nn@X-MUTE<direction_type>. <port_format>.<port_index>.<signal_type>. <index>, state<CR><LF>	The following attributes comprise the signal ID: ▪ <direction_type> – Direction of the port: ○ OUT – Output ▪ <port_format> – Type of signal on the port: ○ HDMI ▪ <port_index> – 1 ▪ <signal_type> – Signal ID attribute: ○ VIDEO ○ AUDIO ▪ <index> – 1 state – OFF/ON (not case sensitive)	Mute the audio on the HDMI output: #X-MUTE<u>out.hdmi.1.audio.1,on<CR>

Function	Description	Syntax	Parameters/Attributes	Example
X-MUTE?	<p>Get mute ON/OFF state on a specific signal.</p> <p>i This command is designed to Mute a Signal. This means that it could be applicable on any type of signal. Could be audio, video and maybe IR, USB or data if this capability is supported by the product.</p> <p>This is an Extended Protocol 3000 command.</p>	<p>COMMAND</p> <pre>#X-MUTE?_<direction_type>.<port_format>.<port_index>.<signal_type>.<index><CR></pre> <p>FEEDBACK</p> <pre>~nn@X-MUTE_<direction_type>.<port_format>.<port_index>.<signal_type>.<index>,<state><CR><LF></pre>	<p>The following attributes comprise the signal ID:</p> <ul style="list-style-type: none"> ▪ <direction_type> – Direction of the port: <ul style="list-style-type: none"> ○ OUT – Output ▪ <port_format> – Type of signal on the port: <ul style="list-style-type: none"> ○ HDMI ▪ <port_index> – 1 ▪ <signal_type> – Signal ID attribute: <ul style="list-style-type: none"> ○ VIDEO ○ AUDIO ▪ <index> – 1 <p>state – OFF/ON (not case sensitive)</p>	<p>Get the video mute ON/OFF state on the HDMI output :</p> <pre>#X-MUTE?_out.hdmi.1.video.1<CR></pre>
X-ROUTE	<p>Send routing command to matrix.</p> <p>i It is recommended to use the command #SIGNALS-LIST to get the list of all signal IDs available in the system and which can be used in this command.</p> <p>This is an Extended Protocol 3000 command.</p>	<p>COMMAND</p> <pre>#X-ROUTE_<direction_type1>.<port_type1>.<port_index1>.<signal_type1>.<index1>,<direction_type2>.<port_type2>.<port_index2>.<signal_type2>.<index2><CR></pre> <p>FEEDBACK</p> <pre>~nn@X-ROUTE_<direction_type1>.<port_type1>.<port_index1>.<signal_type1>.<index1>,<direction_type2>.<port_type2>.<port_index2>.<signal_type2>.<index2><CR><LF></pre>	<p>The following attributes comprise the signal ID:</p> <ul style="list-style-type: none"> ▪ <direction_type> – Direction of the port: <ul style="list-style-type: none"> ○ IN – Input ○ OUT – Output ▪ <port_format> – Type of signal on the port: <ul style="list-style-type: none"> ○ HDMI ○ HDBT ▪ <port_index> – The port number as printed on the front or rear panel: <ul style="list-style-type: none"> ○ HDBT=1 ○ HDMI=1 ▪ <signal_type> – Signal ID attribute: <ul style="list-style-type: none"> ○ VIDEO ▪ <index> – 1 	<p>Route HDBT to the output:</p> <pre>#X-ROUTE_out.hdmi.1.video.1,in.hdbt.1.video.1<CR></pre>
X-ROUTE?	<p>Get routing status.</p> <p>i It is recommended to use the command #SIGNALS-LIST to get the list of all signal IDs available in the system and which can be used in this command.</p> <p>This is an Extended Protocol 3000 command.</p>	<p>COMMAND</p> <pre>#X-ROUTE?_<direction_type1>.<port_type1>.<port_index1>.<signal_type1>.<index1><CR></pre> <p>FEEDBACK</p> <pre>~nn@X-ROUTE_<direction_type1>.<port_type1>.<port_index1>.<signal_type1>.<index1>,<direction_type2>.<port_type2>.<port_index2>.<signal_type2>.<index2><CR><LF></pre>	<p>The following attributes comprise the signal ID:</p> <ul style="list-style-type: none"> ▪ <direction_type> – Direction of the port: <ul style="list-style-type: none"> ○ IN – Input ○ OUT – Output ▪ <port_format> – Type of signal on the port: <ul style="list-style-type: none"> ○ HDMI ○ HDBT ▪ <port_index> – The port number as printed on the front or rear panel: <ul style="list-style-type: none"> ○ HDBT=1 ○ HDMI=1 ▪ <signal_type> – Signal ID attribute: <ul style="list-style-type: none"> ○ VIDEO ▪ <index> – 1 	<p>Get the routing status:</p> <pre>#X-ROUTE?_out.hdmi.1.video.1<CR></pre>
X-SIGNAL?	<p>Get input signal status.</p> <p>i This is an Extended Protocol 3000 command.</p>	<p>COMMAND</p> <pre>#X-SIGNAL?_<direction_type>.<port_format>.<port_index>.<signal_type>.<index><CR></pre> <p>FEEDBACK</p> <pre>~nn@X-SIGNAL_<direction_type>.<port_format>.<port_index>.<signal_type>.<index>,<status><CR><LF></pre>	<p>The following attributes comprise the signal ID:</p> <ul style="list-style-type: none"> ▪ <direction_type> – Direction of the port: <ul style="list-style-type: none"> ○ IN – Input ▪ <port_format> – Type of signal on the port: <ul style="list-style-type: none"> ○ HDMI ○ HDBT ▪ <port_index> – The port number as printed on the front or rear panel: <ul style="list-style-type: none"> ○ HDBT=1 ○ HDMI=1 ▪ <signal_type> – Signal ID attribute: <ul style="list-style-type: none"> ○ VIDEO ▪ <index> – 1 <p>status – Input Signal Status</p> <p>0 – No signal</p> <p>1 – There is a signal</p>	<pre>#X-SIGNAL_in.hdmi.1.video.1<CR></pre> <pre>~01@X-SIGNAL_in.hdmi.1.video.1,1<CR><LF></pre>

Result and Error Codes

Syntax

In case of an error, the device responds with an error message. The error message syntax:

- **~NN@ERR XXX<CR><LF>** – when general error, no specific command
- **~NN@CMD ERR XXX<CR><LF>** – for specific command
- **NN** – machine number of device, default = 01
- **XXX** – error code

Error Codes

Error Name	Error Code	Description
P3K_NO_ERROR	0	No error
ERR_PROTOCOL_SYNTAX	1	Protocol syntax
ERR_COMMAND_NOT_AVAILABLE	2	Command not available
ERR_PARAMETER_OUT_OF_RANGE	3	Parameter out of range
ERR_UNAUTHORIZED_ACCESS	4	Unauthorized access
ERR_INTERNAL_FW_ERROR	5	Internal FW error
ERR_BUSY	6	Protocol busy
ERR_WRONG_CRC	7	Wrong CRC
ERR_TIMEDOUT	8	Timeout
ERR_RESERVED	9	(Reserved)
ERR_FW_NOT_ENOUGH_SPACE	10	Not enough space for data (firmware, FPGA...)
ERR_FS_NOT_ENOUGH_SPACE	11	Not enough space – file system
ERR_FS_FILE_NOT_EXISTS	12	File does not exist
ERR_FS_FILE_CANT_CREATED	13	File can't be created
ERR_FS_FILE_CANT_OPEN	14	File can't open
ERR_FEATURE_NOT_SUPPORTED	15	Feature is not supported
ERR_RESERVED_2	16	(Reserved)
ERR_RESERVED_3	17	(Reserved)
ERR_RESERVED_4	18	(Reserved)
ERR_RESERVED_5	19	(Reserved)
ERR_RESERVED_6	20	(Reserved)
ERR_PACKET_CRC	21	Packet CRC error
ERR_PACKET_MISSED	22	Packet number isn't expected (missing packet)
ERR_PACKET_SIZE	23	Packet size is wrong
ERR_RESERVED_7	24	(Reserved)
ERR_RESERVED_8	25	(Reserved)
ERR_RESERVED_9	26	(Reserved)
ERR_RESERVED_10	27	(Reserved)
ERR_RESERVED_11	28	(Reserved)
ERR_RESERVED_12	29	(Reserved)
ERR_EDID_CORRUPTED	30	EDID corrupted
ERR_NON_LISTED	31	Device specific errors
ERR_SAME_CRC	32	File has the same CRC – not changed
ERR_WRONG_MODE	33	Wrong operation mode
ERR_NOT_CONFIGURED	34	Device/chip was not initialized

The warranty obligations of Kramer Electronics Inc. ("Kramer Electronics") for this product are limited to the terms set forth below:

What is Covered

This limited warranty covers defects in materials and workmanship in this product.

What is Not Covered

This limited warranty does not cover any damage, deterioration or malfunction resulting from any alteration, modification, improper or unreasonable use or maintenance, misuse, abuse, accident, neglect, exposure to excess moisture, fire, improper packing and shipping (such claims must be presented to the carrier), lightning, power surges, or other acts of nature. This limited warranty does not cover any damage, deterioration or malfunction resulting from the installation or removal of this product from any installation, any unauthorized tampering with this product, any repairs attempted by anyone unauthorized by Kramer Electronics to make such repairs, or any other cause which does not relate directly to a defect in materials and/or workmanship of this product. This limited warranty does not cover cartons, equipment enclosures, cables or accessories used in conjunction with this product.

Without limiting any other exclusion herein, Kramer Electronics does not warrant that the product covered hereby, including, without limitation, the technology and/or integrated circuit(s) included in the product, will not become obsolete or that such items are or will remain compatible with any other product or technology with which the product may be used.

How Long this Coverage Lasts

The standard limited warranty for Kramer products is seven (7) years from the date of original purchase, with the following exceptions:

1. All Kramer VIA hardware products are covered by a standard three (3) year warranty for the VIA hardware and a standard three (3) year warranty for firmware and software updates; all Kramer VIA accessories, adapters, tags, and dongles are covered by a standard one (1) year warranty.
2. Kramer fiber optic cables, adapter-size fiber optic extenders, pluggable optical modules, active cables, cable retractors, ring mounted adapters, portable power chargers, Kramer speakers, and Kramer touch panels are covered by a standard one (1) year warranty. Kramer 7-inch touch panels purchased on or after April 1st, 2020 are covered by a standard two (2) year warranty.
3. All Kramer Calibre products, all Kramer Minicom digital signage products, all HighSecLabs products, all streaming, and all wireless products are covered by a standard three (3) year warranty.
4. All Sierra Video MultiViewers are covered by a standard five (5) year warranty.
5. Sierra switchers & control panels are covered by a standard seven (7) year warranty (excluding power supplies and fans that are covered for three (3) years).
6. K-Touch software is covered by a standard one (1) year warranty for software updates.
7. All Kramer passive cables are covered by a lifetime warranty.

Who is Covered

Only the original purchaser of this product is covered under this limited warranty. This limited warranty is not transferable to subsequent purchasers or owners of this product.

What Kramer Electronics Will Do

Kramer Electronics will, at its sole option, provide one of the following three remedies to whatever extent it shall deem necessary to satisfy a proper claim under this limited warranty:

1. Elect to repair or facilitate the repair of any defective parts within a reasonable period of time, free of any charge for the necessary parts and labor to complete the repair and restore this product to its proper operating condition. Kramer Electronics will also pay the shipping costs necessary to return this product once the repair is complete.
2. Replace this product with a direct replacement or with a similar product deemed by Kramer Electronics to perform substantially the same function as the original product. If a direct or similar replacement product is supplied, the original product's end warranty date remains unchanged and is transferred to the replacement product.
3. Issue a refund of the original purchase price less depreciation to be determined based on the age of the product at the time remedy is sought under this limited warranty.

What Kramer Electronics Will Not Do Under This Limited Warranty

If this product is returned to Kramer Electronics or the authorized dealer from which it was purchased or any other party authorized to repair Kramer Electronics products, this product must be insured during shipment, with the insurance and shipping charges prepaid by you. If this product is returned uninsured, you assume all risks of loss or damage during shipment. Kramer Electronics will not be responsible for any costs related to the removal or re-installation of this product from or into any installation. Kramer Electronics will not be responsible for any costs related to any setting up this product, any adjustment of user controls or any programming required for a specific installation of this product.

How to Obtain a Remedy Under This Limited Warranty

To obtain a remedy under this limited warranty, you must contact either the authorized Kramer Electronics reseller from whom you purchased this product or the Kramer Electronics office nearest you. For a list of authorized Kramer Electronics resellers and/or Kramer Electronics authorized service providers, visit our web site at www.kramerav.com or contact the Kramer Electronics office nearest you.

In order to pursue any remedy under this limited warranty, you must possess an original, dated receipt as proof of purchase from an authorized Kramer Electronics reseller. If this product is returned under this limited warranty, a return authorization number, obtained from Kramer Electronics, will be required (RMA number). You may also be directed to an authorized reseller or a person authorized by Kramer Electronics to repair the product.

If it is decided that this product should be returned directly to Kramer Electronics, this product should be properly packed, preferably in the original carton, for shipping. Cartons not bearing a return authorization number will be refused.

Limitation of Liability

THE MAXIMUM LIABILITY OF KRAMER ELECTRONICS UNDER THIS LIMITED WARRANTY SHALL NOT EXCEED THE ACTUAL PURCHASE PRICE PAID FOR THE PRODUCT. TO THE MAXIMUM EXTENT PERMITTED BY LAW, KRAMER ELECTRONICS IS NOT RESPONSIBLE FOR DIRECT, SPECIAL, INCIDENTAL OR CONSEQUENTIAL DAMAGES RESULTING FROM ANY BREACH OF WARRANTY OR CONDITION, OR UNDER ANY OTHER LEGAL THEORY. Some countries, districts or states do not allow the exclusion or limitation of relief, special, incidental, consequential or indirect damages, or the limitation of liability to specified amounts, so the above limitations or exclusions may not apply to you.

Exclusive Remedy

TO THE MAXIMUM EXTENT PERMITTED BY LAW, THIS LIMITED WARRANTY AND THE REMEDIES SET FORTH ABOVE ARE EXCLUSIVE AND IN LIEU OF ALL OTHER WARRANTIES, REMEDIES AND CONDITIONS, WHETHER ORAL OR WRITTEN, EXPRESS OR IMPLIED. TO THE MAXIMUM EXTENT PERMITTED BY LAW, KRAMER ELECTRONICS SPECIFICALLY DISCLAIMS ANY AND ALL IMPLIED WARRANTIES, INCLUDING, WITHOUT LIMITATION, WARRANTIES OF MERCHANTABILITY AND FITNESS FOR A PARTICULAR PURPOSE. IF KRAMER ELECTRONICS CANNOT LAWFULLY DISCLAIM OR EXCLUDE IMPLIED WARRANTIES UNDER APPLICABLE LAW, THEN ALL IMPLIED WARRANTIES COVERING THIS PRODUCT, INCLUDING WARRANTIES OF MERCHANTABILITY AND FITNESS FOR A PARTICULAR PURPOSE, SHALL APPLY TO THIS PRODUCT AS PROVIDED UNDER APPLICABLE LAW. IF ANY PRODUCT TO WHICH THIS LIMITED WARRANTY APPLIES IS A "CONSUMER PRODUCT" UNDER THE MAGNUSON-MOSS WARRANTY ACT (15 U.S.C.A. §2301, ET SEQ.) OR OTHER APPLICABLE LAW, THE FOREGOING DISCLAIMER OF IMPLIED WARRANTIES SHALL NOT APPLY TO YOU, AND ALL IMPLIED WARRANTIES ON THIS PRODUCT, INCLUDING WARRANTIES OF MERCHANTABILITY AND FITNESS FOR THE PARTICULAR PURPOSE, SHALL APPLY AS PROVIDED UNDER APPLICABLE LAW.

Other Conditions

This limited warranty gives you specific legal rights, and you may have other rights which vary from country to country or state to state.

This limited warranty is void if (i) the label bearing the serial number of this product has been removed or defaced, (ii) the product is not distributed by Kramer Electronics or (iii) this product is not purchased from an authorized Kramer Electronics reseller. If you are unsure whether a reseller is an authorized Kramer Electronics reseller, visit our web site at www.kramerav.com or contact a Kramer Electronics office from the list at the end of this document.

Your rights under this limited warranty are not diminished if you do not complete and return the product registration form or complete and submit the online product registration form. Kramer Electronics thanks you for purchasing a Kramer Electronics product. We hope it will give you years of satisfaction.



P/N:



2900-301501

Rev:



1



SAFETY WARNING

Disconnect the unit from the power supply before opening and servicing

For the latest information on our products and a list of Kramer distributors, visit our website where updates to this user manual may be found.

We welcome your questions, comments, and feedback.

The terms HDMI, HDMI High-Definition Multimedia Interface, and the HDMI Logo are trademarks or registered trademarks of HDMI Licensing Administrator, Inc. All brand names, product names, and trademarks are the property of their respective owners.