



KRAMER ELECTRONICS LTD.

USER MANUAL

MODEL:

FC-28

Ethernet Controller

P/N: 2900-300539 Rev 1



FC-28 Ethernet Controller Quick Start Guide

This guide helps you install and use your **FC-28** for the first time. For more detailed information, go to <http://www.kramerav.com/manual/FC-28> to download the latest manual or scan the QR code on the left.

Step 1: Check what's in the box

- ✓ **FC-28** Ethernet Controller
- ✓ 1 Power supply 5V DC
- ✓ 4 Rubber feet
- ✓ 1 IR cable (C-A35M/RE-10)
- ✓ 1 Quick Start Guide
- ✓ 1 Bracket kit

Step 2: Install the FC-28

To mount the **FC-28** in a rack, use an **RK-2TB** rack adapter. Alternatively, attach the rubber feet to the underside of the machine and place it on a table. You can use the TOOL bracket Installation kit (supplied) to mount the **FC-28** on a desktop, wall or similar area. Fasten a bracket on each side of the MegaTOOL using the two M3x8 screws (supplied). Use the flat-head screws (supplied) to fix the MegaTOOL to the mounting surface or enable it to slide in place.

Step 3: Connect the inputs and outputs

Always switch off the power to each device before connecting it to your **FC-28**.
For best results, always use Kramer high-performance cables to connect your AV equipment to the **FC-28**.

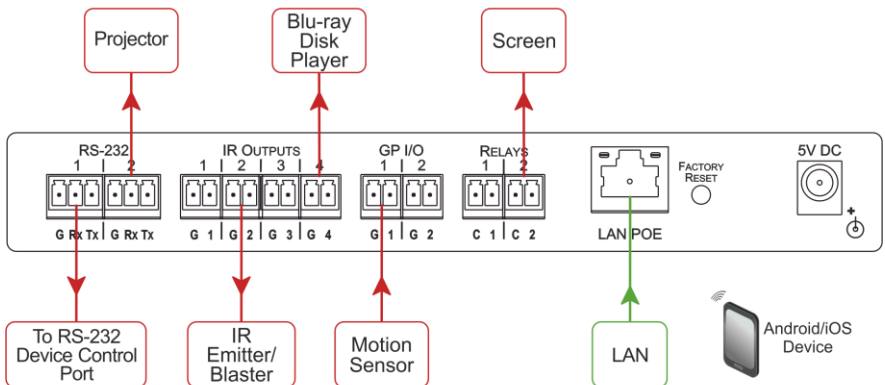

Step 4: Connect the power

If the device does not receive power via PoE, connect the power adapter to the **FC-28** and plug the power adapter it into the mains electricity.



Step 5: Configure and Operate the FC-28

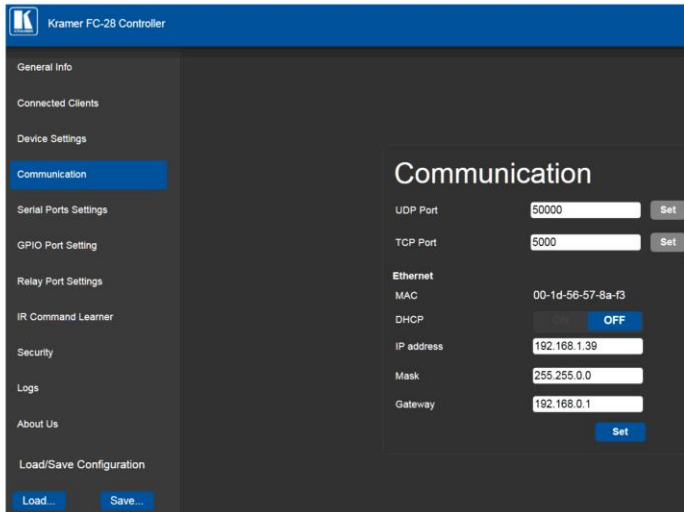

Note: The **FC-28** is dispatched from the factory with the DHCP enabled and a random IP address. This means that if the device is connected to a LAN, you must identify the IP address of the **FC-28** in order to connect to it. This can be done by using K-LAN Configurator which is available for download from our Web site at <http://www.kramerav.com>.

To browse the **FC-28** Web pages on taking the device out of the box, use the default host name "FC-28-xxxx", where "xxxx" are the last four digits of the serial number of the device.

Note: If you perform a factory reset, DHCP is disabled and the IP address of the device is set to 192.168.1.39

To reset the device to its factory default settings:

1. Turn off the power to the device.
2. Press and hold the Reset button on the front panel.
3. Turn on the power to the device while holding down the Reset button for a few seconds.
4. Release the button.

The device is reset to the factory default settings.

To configure and operate the FC-28:

1. Using the embedded Web pages, configure the Ethernet controller:
 - Set DHCP or assign a static IP address
 - Associate IP port(s) with serial port(s)
 - Configure the serial port parameters
2. Configure virtual port(s) on the K-Touch control device/PC.
3. Configure Ethernet connection(s) on the K-Touch control device/PC.
4. Switch port(s) on the Ethernet Controller.

Contents

1	Introduction	1
2	Getting Started	2
2.1	Achieving the Best Performance	2
2.2	Safety Instructions	2
2.3	Recycling Kramer Products	3
3	Overview	4
3.1	About the Power over Ethernet Feature	6
4	Defining the FC-28 Ethernet Controller	7
5	Initial Configuration and Use Overview	9
5.1	Configuring the FC-28 Ethernet Controller	9
5.2	Configuring a Virtual Port on the PC	11
5.3	Setting Up an Ethernet Connection on the PC	11
6	Connecting the FC-28	12
6.1	Connecting via Ethernet	13
7	Remote Operation via the Web Pages	18
7.1	Browsing the Web Pages	18
7.2	Connected Clients Page	20
7.3	Device Settings Page	21
7.4	Communication Page	23
7.5	Serial Port Settings Page	23
7.6	GPIO Port Settings Page	25
7.7	Relay Port Settings Page	31
7.8	IR Command Learner Page	32
7.9	Security Page	33
7.10	Logs Page	35
7.11	About Us Page	36
8	Configuring and Maintaining the FC-28	37
8.1	IR Learning	37
8.2	Resetting to the Factory Default Settings	38
8.3	Upgrading the Firmware	38
9	Technical Specifications	39
9.1	Data Handling Performance	40
9.2	Example Bandwidth Calculation	40
9.3	TCP/UDP Port Limitations	41
10	Default Communication Parameters	42
11	Kramer Protocol 3000	43
11.1	Kramer Protocol 3000 – Syntax	43
11.2	Kramer Protocol 3000 – Command List	46
11.3	Kramer Protocol 3000 – Detailed Commands	47
11.4	Parameters	72

Figures

Figure 1: FC-28 Controlling Devices Remotely Using K-Touch 3.0 over a LAN	5
Figure 2: FC-28 Ethernet Controller Front Panel	7
Figure 3: FC-28 Ethernet Controller Rear Panel	8
Figure 4: Connecting the FC-28 for Initial Configuration	9
Figure 5: Configuring a Remote Connection	11
Figure 6: Connecting the FC-28 Ethernet Controller	12
Figure 7: Local Area Connection Properties Window	14
Figure 8: Internet Protocol Version 4 Properties Window	15
Figure 9: Internet Protocol Version 6 Properties Window	15
Figure 10: Internet Protocol Properties Window	16
Figure 11: General Info Page	19
Figure 12: Connected Clients Page	20
Figure 13: Device Settings Page	21
Figure 14: Communication Page	23
Figure 15: Serial Port Settings Page	24
Figure 16: GPI/O Port Settings Page Digital IN	26
Figure 17: GPI/O Port Settings Page Digital OUT	28
Figure 18: Digital Out Selection Warning Popup	28
Figure 19: GPI/O Port Settings Page Analog IN	30
Figure 20: Relay Port Settings Page	31
Figure 21: IR Command Learner Page	32
Figure 22: Security Page	33
Figure 23: Security Confirmation Popup	33
Figure 24: Authentication Required Popup	34
Figure 25: Security Activated Page	34
Figure 26: Logs Page	35
Figure 27: About Us Page	36

1 Introduction

Welcome to Kramer Electronics! Since 1981, Kramer Electronics has been providing a world of unique, creative, and affordable solutions to the vast range of problems that confront video, audio, presentation, and broadcasting professionals on a daily basis. In recent years, we have redesigned and upgraded most of our line, making the best even better!

Our 1,000-plus different models now appear in 13 groups that are clearly defined by function: GROUP 1: Distribution Amplifiers; GROUP 2: Switchers and Routers; GROUP 3: Control Systems; GROUP 4: Format/Standards Converters; GROUP 5: Range Extenders and Repeaters; GROUP 6: Specialty AV Products; GROUP 7: Scan Converters and Scalers; GROUP 8: Cables and Connectors; GROUP 9: Room Connectivity; GROUP 10: Accessories and Rack Adapters; GROUP 11: Sierra Video Products; GROUP 12: Digital Signage; GROUP 13: Audio, and GROUP 14: Collaboration.

Congratulations on purchasing your Kramer **FC-28 Ethernet Controller** which is ideal for use with Ethernet/RS-232 interfaces.

2 Getting Started

We recommend that you:

- Unpack the equipment carefully and save the original box and packaging materials for possible future shipment
- Review the contents of this user manual
- Use Kramer high performance high resolution cables



Go to <http://www.kramerav.com/downloads/FC-28> to check for up-to-date user manuals, application programs, and to check if firmware upgrades are available (where appropriate).

2.1 Achieving the Best Performance

To achieve the best performance:

- Use only good quality connection cables (we recommend Kramer high-performance, high-resolution cables) to avoid interference, deterioration in signal quality due to poor matching, and elevated noise levels (often associated with low quality cables)
- Do not secure the cables in tight bundles or roll the slack into tight coils
- Avoid interference from neighboring electrical appliances that may adversely influence signal quality
- Position your Kramer **FC-28**, and away from moisture, excessive sunlight and dust



This equipment is to be used only inside a building. It may only be connected to other equipment that is installed inside a building.

2.2 Safety Instructions



Caution: There are no operator serviceable parts inside the unit

Warning: Use only the Kramer Electronics input power wall adapter that is provided with the unit.

Warning: Disconnect the power and unplug the unit from the wall before installing

2.3 Recycling Kramer Products

The Waste Electrical and Electronic Equipment (WEEE) Directive 2002/96/EC aims to reduce the amount of WEEE sent for disposal to landfill or incineration by requiring it to be collected and recycled. To comply with the WEEE Directive, Kramer Electronics has made arrangements with the European Advanced Recycling Network (EARN) and will cover any costs of treatment, recycling and recovery of waste Kramer Electronics branded equipment on arrival at the EARN facility. For details of Kramer's recycling arrangements in your particular country go to our recycling pages at <http://www.kramerelectronics.com/support/recycling/>.

3 Overview

The **FC-28** is bidirectional RS-232, IR control, GP I/O and relay control signal to Ethernet converter. It allows two RS-232, four IR, two GP I/O, and two relay-controllable devices to be controlled via an Ethernet or LAN connection.

These Ethernet to I/O controllers bridge the gap between Ethernet infrastructures and I/O communication devices by offering bidirectional Ethernet to any I/O interface conversion. All setup and maintenance of the devices is done from built-in Web pages which are accessible using any common Web browser.

The **FC-28** can receive [K-Touch](#) Ethernet-based per-I/O port commands and convert them into I/O interface signals on the requested I/O port. Responses are sent back to all Ethernet connected panels.

In particular, the **FC-28**:

- Offers network connectivity that lets you connect a Kramer (or other) device via its control I/O port to an Ethernet LAN
- Works in conjunction with **K-Touch 3** for remote control of devices over an Ethernet LAN via I/O interface connections, (see [Figure 1](#))
- Provides control of up to two RS-232 devices via Ethernet from a PC, tablet, smartphone, and so on
- Provides up to four IR ports for device control via IR blasters/emitters
- Provides input/output triggering for up to two devices via the GP I/O ports
- Provides control of up to two devices via built-in relays
- Provides control of a device from multiple Ethernet points (PCs or remote controllers), via a LAN or the Internet
- Has built-in IR learning capabilities
- Includes Windows®-based Virtual Port software for setting up virtual ports on a PC
- Supports static or dynamic (DHCP) IP addressing
- Can act as a PoE receiver

- Has a USB port for upgrading the firmware
- Supports remote firmware upgrades via a LAN
- Is housed in a compact, Kramer MegaTOOL™ enclosure which can be mounted side by side in a 19-inch rack using suitable rack adapters

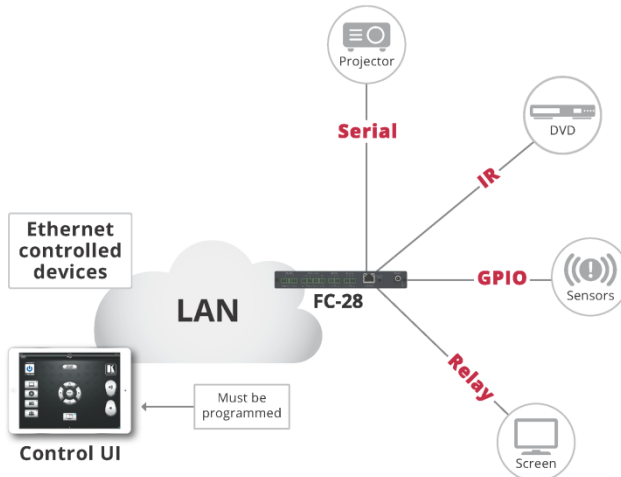

Figure 1: FC-28 Controlling Devices Remotely Using K-Touch 3.0 over a LAN

Using **K-Touch** you can design advanced room-control and automation systems that can be operated from iOS or Android touch devices. **K-Touch** can be used to perform device discovery over the network as the **FC-28** is set to be a DHCP client by default.

You can use the Kramer [LAN Configurator](#) software to discover devices that are attached to the network, including the **FC-28**.

The **FC-28** includes the Virtual Serial Port Manager (Kramer VSPM) for compatibility with applications based on COM-port communication. Virtual Serial Port Manager:

- Makes the **FC-28** compatible with all Windows®-based applications which require a physical COM port. This includes all versions of [K-Router](#) and

other Kramer control applications. It lets you operate all RS-232 controllable devices via an Ethernet LAN using their existing PC software

- Allows virtual serial ports to operate like physical COM ports, that is, logical COM ports that behave exactly like a standard hardware COM port. In reality, it transparently reroutes the data using the TCP/IP network to the **FC-28** interface via a virtual connection which you can emulate over the Ethernet or Internet
- Allows the creation of any number of serial ports on your PC which do not occupy any physical serial ports

3.1 About the Power over Ethernet Feature

Power over Ethernet passes electrical power along with data on Ethernet cabling. This allows a single cable to provide both data connection and electrical power to compatible devices.

4 Defining the FC-28 Ethernet Controller

Figure 2 defines the front panel of the **FC-28**.

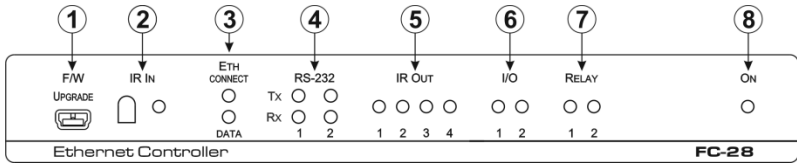

Figure 2: FC-28 Ethernet Controller Front Panel

#	Feature	Function
1	<i>FW UPGRADE</i> Mini USB Connector	Connect to a PC to perform a firmware upgrade
2	<i>IR IN</i> Sensor	Sensor for IR learning
3	<i>ETH</i> LEDs	<i>CONNECT</i> Lights orange when the Ethernet port is connected
	<i>DATA</i>	Flashes green when data is transferred over the Ethernet link
4	<i>RS-232</i> LEDs	<i>TX 1</i> Lights green when data is transmitted on serial port 1
		<i>RX 1</i> Lights red when data is received on serial port 1
		<i>TX 2</i> Lights green when data is transmitted on serial port 2
	<i>RX 2</i> Lights red when data is received on serial port 2	
5	<i>IR OUT 1 ~ 4</i> LEDs	The associated LED lights green when the relevant IR port transmits data. Note: When IR learning is in progress, the relevant IR Out LED lights and the FC-28 is unavailable for normal operation
6	<i>I/O 1 ~ 2</i> LEDs	Lights green when the port is triggered
7	<i>RELAY 1 ~ 2</i> LEDs	Lights green when the relay is closed
8	<i>ON</i> LED	Lights green when the unit is on

Figure 3 defines the rear panel of the FC-28.

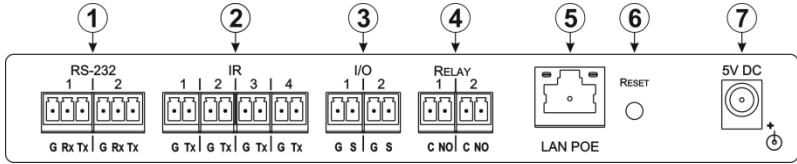

Figure 3: FC-28 Ethernet Controller Rear Panel

#	Feature	Function	
1	RS-232 Two 3-pin Terminal Blocks	1	Connect to the first RS-232 controlled device
		2	Connect to the second RS-232 controlled device
2	IR 1 ~ 4 Four 2-pin Terminal Blocks	Connect to IR blasters/emitters using cables up to 80m (260ft) long	
3	I/O Two 2-pin Terminal Blocks	1	Connect to sensors or devices to be controlled, (for example, a motion sensor). Port may be configured as a digital input, digital output, or analog input
		2	Connect to the second sensor or device to be controlled
4	RELAY Two 2-pin Terminal Blocks	1	Connect to the first device to be controlled by relay, (for example, a motorized projection screen)
		2	Connect to the second device to be controlled by relay
5	LAN POE RJ-45 Connector	Connect to a PC or other controller directly or via a LAN (see Section 6.1)	
6	RESET Button	Press and hold while power-cycling the device to reset to factory default parameters, (see Section 10)	
7	5V DC Connector	Connect to the 5V DC power supply, center pin positive. External power supply is not needed when the device is supplied power by a PoE provider	

5 Initial Configuration and Use Overview

This chapter provides an overview of the initial configuration and basic operation of the **FC-28** and comprises:

- Configuring the **FC-28** (see [Section 5.1](#))
- Configuring a virtual port on the PC (see [Section 5.2](#))
- Configuring an Ethernet connection on the PC (see [Section 5.3](#))

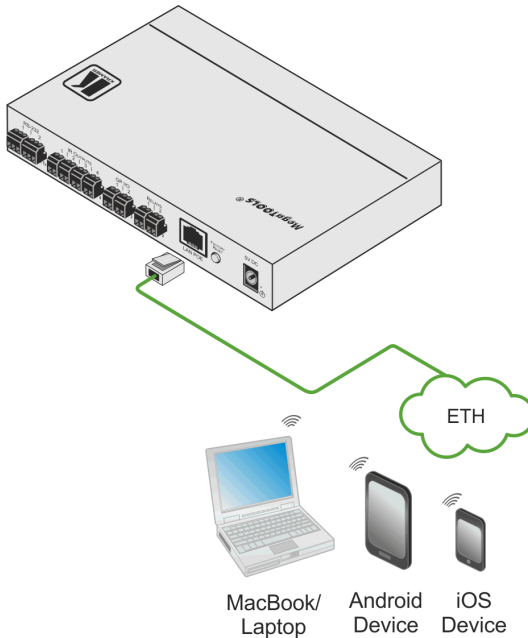

Figure 4: Connecting the FC-28 for Initial Configuration

5.1 Configuring the FC-28 Ethernet Controller

Note: The **FC-28** is dispatched from the factory with DHCP enabled and a random IP address. This means that in order to connect to the **FC-28** on first installation, you need to identify what IP address has been automatically assigned to the **FC-28**. This can be done by using [K-LAN Configurator](#) to discover the IP address of the **FC-28**. This is available for download from our website at <http://www.kramerav.com>.

To browse the **FC-28** Web pages on taking the device out of the box, use the default host name, (see [Section 10](#)).

To configure the FC-28:

1. Connect the Ethernet port on the rear panel of the **FC-28** to a PC, either directly or via a LAN, (see [Section 6.1](#)).
2. Using a Web browser and the relevant IP address, browse the General Info home page (see [Figure 11](#)).
3. Click on Device Settings to browse to the Device Settings page, (see [Figure 13](#)).
4. Enter the time and date manually, or enter the Time server address for automatic time and date synchronization.
5. Click Save Changes.
6. Click on Communication to browse to the Communication page, (see [Figure 14](#)).
7. Enter the IP address, mask and gateway for static IP addressing and Click Set. We recommend that you set a meaningful host name.
Note: If you have changed the IP from the default setting, you must reload the General Info home page again using the new IP address.
8. Click on Serial Ports Settings to browse to the Serial Port Settings page, (see [Figure 15](#)).
9. Associate the required serial ports with their corresponding TCP/UDP settings.
10. For each associated serial port, enter the serial port configuration parameters using the drop-down lists under Serial Configuration.
11. Click Save Changes.
12. If required, click on Security to browse to the Security page.

13. Click ON to activate security.

The user name and password credentials popup appears.

14. Enter the required user name and password.

5.2 Configuring a Virtual Port on the PC

If the control application cannot work with an Ethernet driver, download the Kramer **VSPM** from our Web site to set a virtual port for each local port on your **FC-28**.

The Kramer **VSPM** software lets you emulate virtual ports which normally would be present in the machine hardware. After setup, the virtual port lets you control Kramer machines via your PC.

5.3 Setting Up an Ethernet Connection on the PC

If the control application can directly connect to the Ethernet driver, select the host IP and port number according to your **FC-28** configuration, as illustrated in [Figure 5](#).

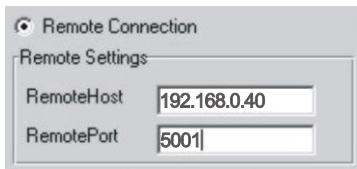

Figure 5: Configuring a Remote Connection

6 Connecting the FC-28



Always switch off the power to each device before connecting it to your **FC-28**. After connecting your **FC-28**, connect its power and then switch on the power to each device.

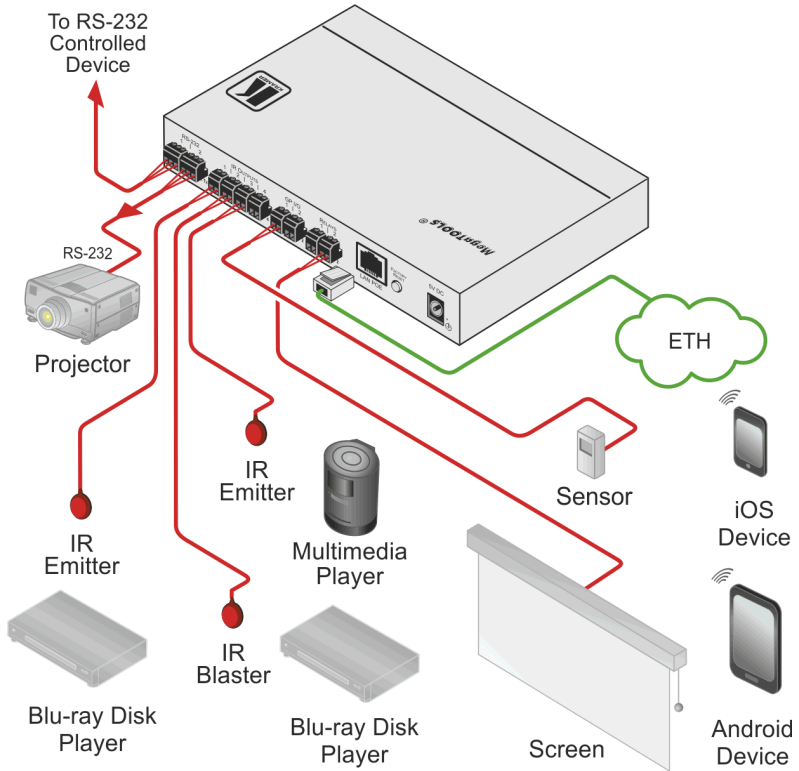

Figure 6: Connecting the FC-28 Ethernet Controller

To connect the FC-28 as illustrated in the example in [Figure 6](#):

1. Connect the device to a LAN or PC via the RJ-45 Ethernet connector.
2. Connect up to two serially controlled devices, (for example, the control port of a switcher and a projector) to the 3-pin, RS-232 terminal blocks.

3. Connect IR emitters to the IR Outputs, (for example, two IR emitters for Blu-ray disk player and multimedia player control, and an IR blaster for a second Blu-ray disk player).
4. Connect a Relays port to a device to be controlled, (for example, an electric screen).
5. Connect a GP I/O port to a input/output device, (for example, a sensor).
6. If the **FC-28** cannot be powered by a PoE power source, connect the device to the power adapter and connect the power adapter to the mains electricity (not shown in [Figure 6](#)).

6.1 Connecting via Ethernet

You can connect to the **FC-28** via Ethernet using either of the following methods:

- Directly to the PC using a crossover cable (see [Section 6.1.1](#))
- Via a network hub, switch, or router, using a straight-through cable (see [Section 6.1.2](#))

Note: If you want to connect via a router and your IT system is based on IPv6, speak to your IT department for specific installation instructions.

6.1.1 Connecting the Ethernet Port Directly to a PC

You can connect the Ethernet port of the **FC-28** directly to the Ethernet port on your PC using a crossover cable with RJ-45 connectors.



This type of connection is recommended for identifying the **FC-28** with the factory configured default IP address.

After connecting the **FC-28** to the Ethernet port, configure your PC as follows:

1. Click **Start > Control Panel > Network and Sharing Center**.
2. Click **Change Adapter Settings**.
3. Highlight the network adapter you want to use to connect to the device and click **Change settings of this connection**.

The Local Area Connection Properties window for the selected network adapter appears as shown in [Figure 7](#).

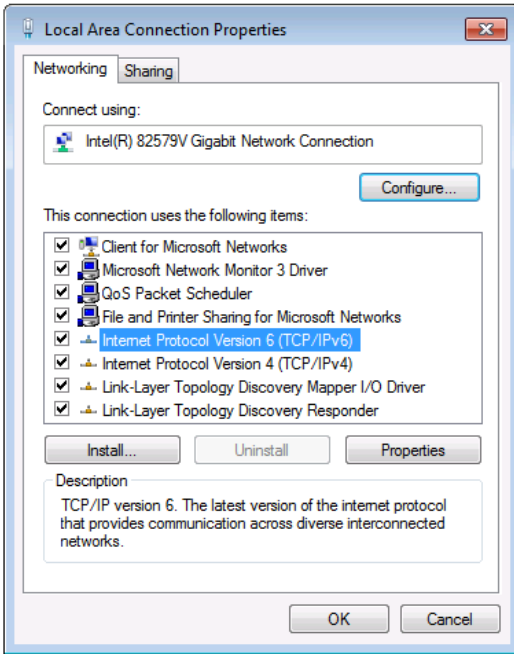

Figure 7: Local Area Connection Properties Window

4. Highlight **Internet Protocol Version 4 (TCP/IPv4)** and click **Properties**.
The Internet Protocol Properties window relevant to your IT system appears as shown in [Figure 8](#) or [Figure 9](#).

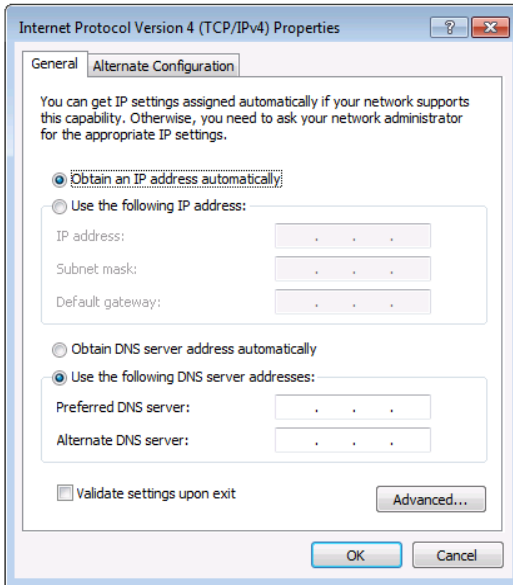

Figure 8: Internet Protocol Version 4 Properties Window

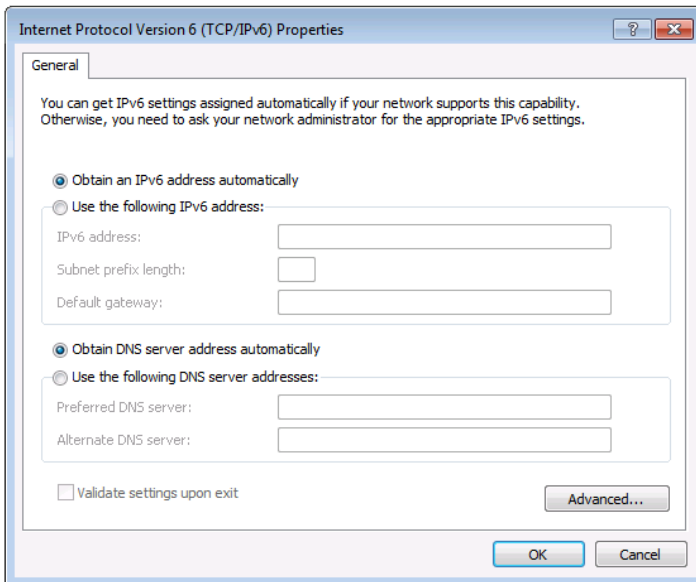

Figure 9: Internet Protocol Version 6 Properties Window

5. Select **Use the following IP Address** for static IP addressing and fill in the details as shown in [Figure 10](#).

For TCP/IPv4 you can use any IP address in the range 192.168.1.1 to 192.168.1.255 (excluding 192.168.1.39) that is provided by your IT department.

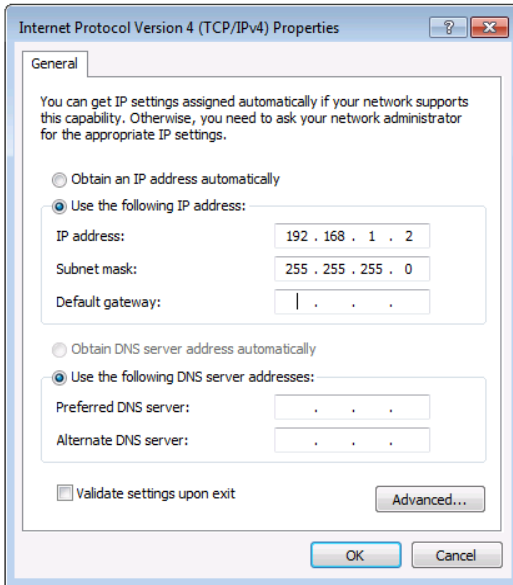

Figure 10: Internet Protocol Properties Window

6. Click **OK**.
7. Click **Close**.

6.1.2 Connecting the Ethernet Port via a Network Hub or Switch

You can connect the Ethernet port of the **FC-28** to the Ethernet port on a network hub or using a straight-through cable with RJ-45 connectors.

6.1.3 Connecting to the FC-28 via RS-232 or IR

To connect to the FC-28 via RS-232:

- Connect the RS-232, 3-pin, terminal block connectors on the rear panel of the **FC-28** using 3-wire cable (pin TX to pin 2, RX to pin 3, and G to pin 5) to the RS-232 9-pin D-sub port on the devices to be controlled

To connect to the FC-28 via IR either:

- Connect an IR blaster to one of the IR Outputs and place it within 4m to 8m (13 to 26ft) and in line-of-sight of the device to be controlled

—OR—

- Connect an IR emitter cable to one of the IR Outputs and stick the emitter to the IR sensor on the device to be controlled

Note: The IR emitter is sometimes supplied with a 3.5mm mini jack connector. To connect the emitter to the IR terminal block, cut off the plug and connect the black wire to the G pin and the white-striped wire to the TX pin on the terminal block.

6.1.4 Connecting the GP I/O Ports on the FC-28 to a Device

To connect the GP I/O port on the FC-28 to a device:

- Connect the G pin on the GP I/O port to the ground connection on the device
- Connect the S pin on the GP I/O port to the signal/positive connection on the device

6.1.5 Connecting the Relays on the FC-28 to a Device

To connect the relay port on the FC-28 to a device:

- Connect the C pin on the relay port to one side of the device to be switched
- Connect the NO pin on the relay port to the other side of the device to be switched

7 Remote Operation via the Web Pages

The embedded Web pages can be used to remotely operate the **FC-28** using a Web browser and an Ethernet connection.

Before attempting to connect:

- Perform the procedures in [Section 5.1](#) and in [Section 6.1](#)
- Ensure that your browser is supported (see [Section 9](#))

Note: The specific parameter values shown in screenshots are merely representative.

7.1 Browsing the Web Pages

To browse the Web pages:

1. Open your Internet browser. Type the IP address of the device (see [Section 5.1](#)) in the Address bar of your browser.



The Loading page appears followed shortly by the General Info page shown in [Figure 11](#).

The General Info page displays the following:

- Model name
- Firmware version
- Device serial number
- Web page version

At the bottom left hand side of all pages there are Load/Save Configuration buttons. These allow you to save the current configuration and load any pre-saved configurations.

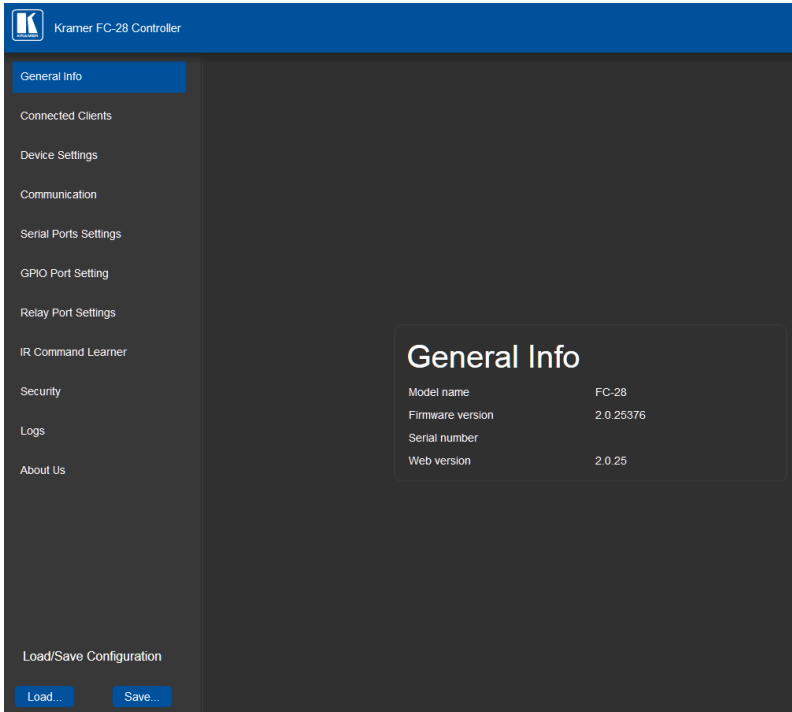

Figure 11: General Info Page

7.1.1 Loading and Saving Configurations

You can save a configuration for easy recall in the future.

Loading and saving configurations can be performed using the buttons at the bottom left-hand side of the screen irrespective of which page is displayed.

To load a configuration:

1. Click Load.
The Explorer window opens.
2. Browse to the required file.
3. Select the required file and click Open.
The device is configured according to the saved preset.

To save the current configuration:

1. Configure the device as required.
2. Click Save.
The Save File window opens.
3. Browse to the required location to which to save the file.
4. Enter the required name for the saved preset.
5. Click OK.
The current configuration is saved.

Note: When using Chrome, the file is automatically saved in the Downloads folder.

7.2 Connected Clients Page

The Connected Clients page allows you to view the following details of any client devices connected via Ethernet to the **FC-28**:

- IP address
- The port to which it is connected
- Method of connection
- Whether or not Send Replies is enabled for the port

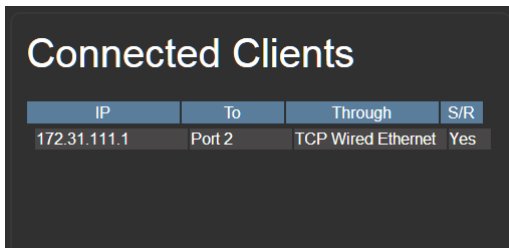

The screenshot shows a dark-themed interface with the title "Connected Clients" in white. Below the title is a table with four columns: "IP", "To", "Through", and "S/R". The table contains one row of data with the following values: "172.31.111.1", "Port 2", "TCP Wired Ethernet", and "Yes".

IP	To	Through	S/R
172.31.111.1	Port 2	TCP Wired Ethernet	Yes

Figure 12: Connected Clients Page

7.3 Device Settings Page

The Device Settings page allows you to view the model name and time server status. You can also edit the following fields:

- Device name
- Device time, date, and time zone
- Use a time server to set the time and date automatically (if the device is connected to the Internet), including the Time Zone and daylight savings time

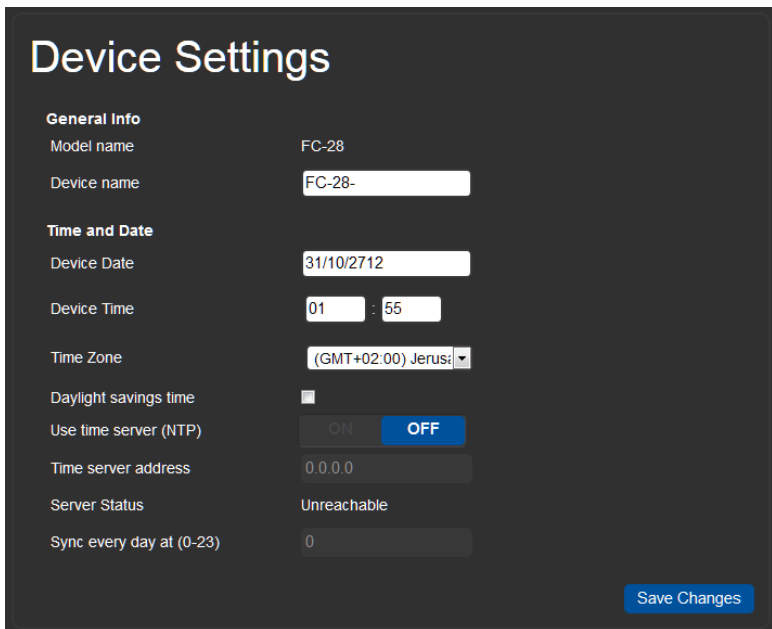

The screenshot shows the 'Device Settings' page with the following fields and values:

General Info	
Model name	FC-28
Device name	<input type="text" value="FC-28-"/>
Time and Date	
Device Date	<input type="text" value="31/10/2712"/>
Device Time	<input type="text" value="01"/> : <input type="text" value="55"/>
Time Zone	<input type="text" value="(GMT+02:00) Jerus:"/> ▾
Daylight savings time	<input type="checkbox"/>
Use time server (NTP)	<input type="button" value="ON"/> <input checked="" type="button" value="OFF"/>
Time server address	<input type="text" value="0.0.0.0"/>
Server Status	Unreachable
Sync every day at (0-23)	<input type="text" value="0"/>

Figure 13: Device Settings Page

General Info:

- Model Name—Name of the model, read only
- Device Name—Name used by DNS when addressing the device. Important for accessing the device for the first time using a Web browser, read/write

Time and Date:

- Device Date—Date used by the device for logging purposes. When using a time server, read only; when not using a time server, read/write
- Device Time—Time used by the device for logging purposes. When using a time server, read only; when not using a time server, read/write
- Use Time Server—When on, the device automatically synchronizes its internal clock with the time server (using NTP) and you must provide a valid time server IP address
- Sync Every Day at (0-23)—Hour of the day at which to synchronize the time and date with the time server

Note: If you utilize the logging function, (see [Section 7.10](#)) it is important that the device date and time are set and maintained correctly.

To enable NTP synchronization:

1. Browse to the Device Settings page by clicking Device Settings.
The Device Settings page is displayed as shown in [Figure 13](#).
2. Click the Use Time Server ON button.
3. Enter the IP address of the Time Server.
4. Enter the hour of the day at which the **FC-28** should synchronize with the Time Server.
5. Click Save Changes.

7.4 Communication Page

The communication page allows you to:

- Turn DHCP for the device on and off
- Edit the IP settings for static IP addressing

Note: The default IP address setting for the device is DHCP on.

Communication

UDP Port

TCP Port

Ethernet

MAC

DHCP

IP address

Mask

Gateway

Figure 14: Communication Page

After modifying the IP address, Mask, or Gateway, click Set to save the changes.

7.5 Serial Port Settings Page

The Serial Port Settings page allows you to:

- Set the following Ethernet parameters for each Ethernet port:
 - Select TCP or UDP
 - IP Port—TCP or UDP port number
 - TCP keep alive time

- Set the following serial parameters for each serial port:
 - Parity
 - Data bits
 - Baud rate
 - Stop bits
- Select whether or not to send replies on the port to the new client, (see also [Section 7.2](#))

Serial Port Settings

PORT SETTINGS

1
2

Ethernet settings - port #2

Protocol UDP **TCP**

IP Port 5003

Device Serial Mode RS-232

TCP Keep alive (sec) 45

Serial Configuration

Parity None

Data Bits 8

Baud rate 9600

Stops Bits 1

Send Replies to new client by default **ON** OFF

Reset Ethernet Settings **Save Changes**

Figure 15: Serial Port Settings Page

7.6 GPIO Port Settings Page

The GPIO Port Setting page allows you to configure the following for each GP I/O port:

- Trigger type—digital input, digital output, or analog input
- Enable and disable the pull-up resistor, (for digital input and output)
- Set the threshold trigger voltage range, (for digital input)
- Set the current status for the digital output signal to high or low, (for digital output)
- Set the maximum number of reported steps for the analog input
- Read—Press to read the state of the port
- State—Displays the digital state of the port, either 1 (high) or 0 (low)

Note: The default parameter settings change depending on which trigger type is selected.

7.6.1 Digital In Trigger Type

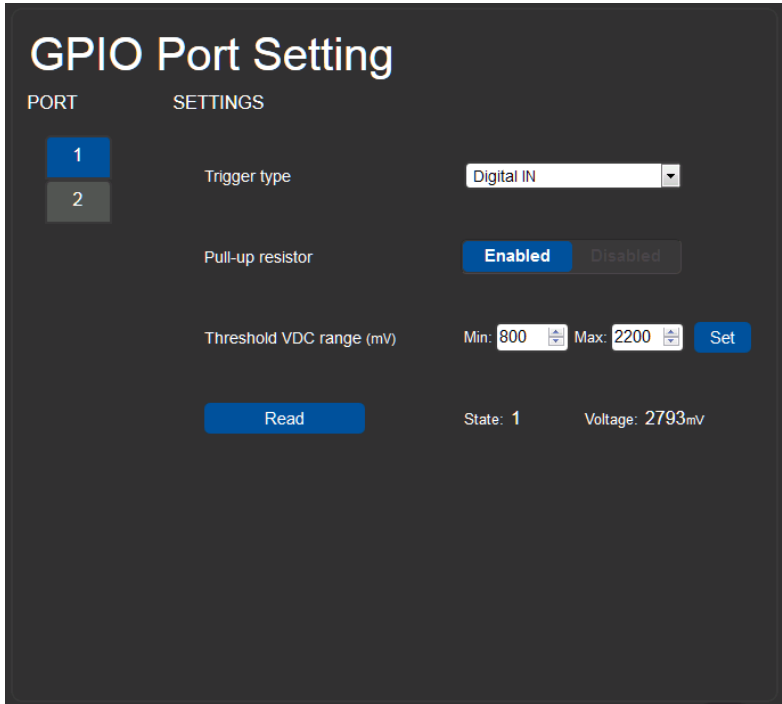

Figure 16: GPI/O Port Settings Page Digital IN

Set the trigger type to Digital In. With this selection, the port is triggered by an on/off external device, such as, a sensor.

Note: You must set the threshold voltage at which the port changes state.

When the pull-up is enabled, the port state is high and to be triggered it must be pulled low by the externally connected sensor. When disabled, the port state is low and to be triggered it must be pulled high by the externally connected sensor.

The pullup resistor can be disabled or enabled:

1. Disabled:

- Detects voltage levels and their high or low transition per defined threshold level
- Configurable threshold levels, (with hysteresis of $\geq 0.8V$ DC):
 - Low to high threshold; 2 to 30V DC (default is 2.2V)
 - High to low threshold; 28 to 0.5V DC (default is 0.8V)

2. Enabled:

- Detection of either a short circuit, (activating the high to low trigger, closed circuit) or no short circuit, (activating the low to high trigger, open circuit) using the internal pullup resistor
- Configurable threshold levels, (with hysteresis of $\geq 0.8V$ DC):
 - Low to high threshold; 2 to 4V DC (default is 2.2V)
 - High to low threshold; 3 to 0.5V DC (default is 0.8V)

7.6.2 Digital Out Trigger Type

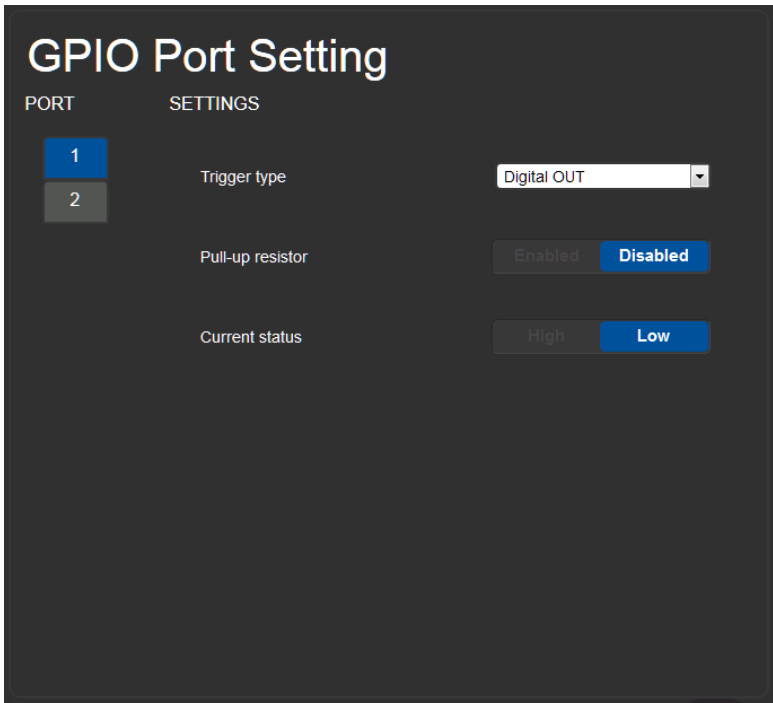

Figure 17: GPI/O Port Settings Page Digital OUT

Set the trigger type to Digital Out. With this selection, the external device, (for example, an electric blind) is controlled by the **FC-28**.

When selecting the Digital Out trigger type, the warning popup shown in Figure 18 is displayed.

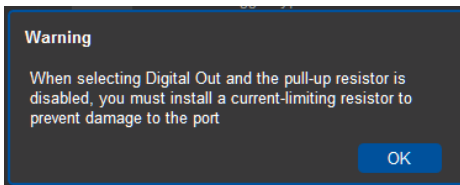

Figure 18: Digital Out Selection Warning Popup

You can select to have the pullup resistor enabled or disabled. When enabled, the port state is high. For the state to be low, you must click Low from the Current Status. When disabled, the port state is low and to set it high, you must click High from the Current Status.

The pullup resistor can be disabled or enabled:

1. Disabled:

- Rated for up to 30V DC external drive voltage
- Sinks up to 100mA continuous current

Note: In this state, you must connect an external resistor to limit the current

2. Enabled:

- Acts as a TTL positive logic output
- Low $\leq 0.5V$ DC
- High $\geq 3.3V$ DC
 - Drives up to 10mA current
 - Output impedance of 330Ω

7.6.3 Analog In Trigger Type

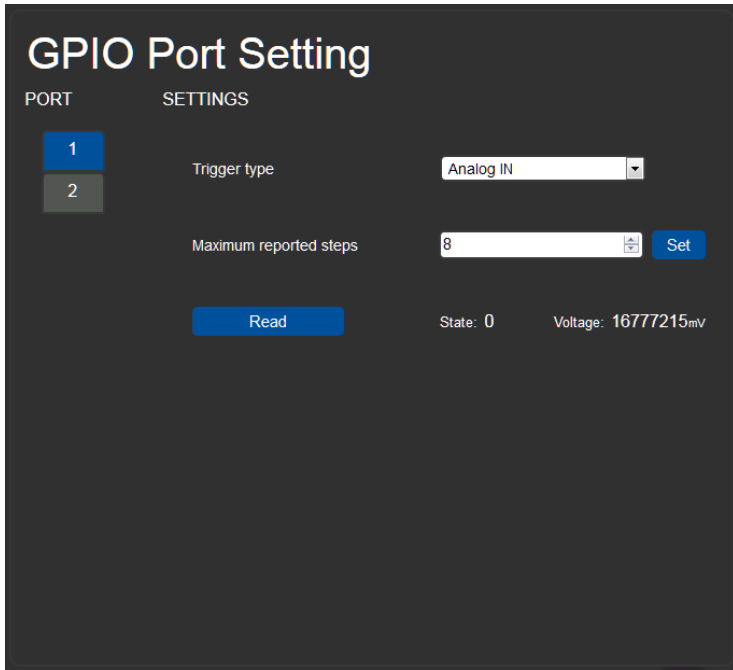

Figure 19: GPI/O Port Settings Page Analog IN

Set the trigger type to Analog In. With this selection, the port is triggered by an analog external device, such as, a volume control device.

You can select the number of steps the analog input signal will be divided into, starting with step 1 and with a maximum of 100. The voltage of each step is dependent on the number of steps selected:

Individual step voltage = 30V / number of steps

When Analog In is selected, the ports:

- Accept analog signals from an auxiliary device
- Are rated for 0 to 30V DC
- Have no pullup resistor

7.7 Relay Port Settings Page

The Relay Port Settings page allows you to turn the relays on and off.

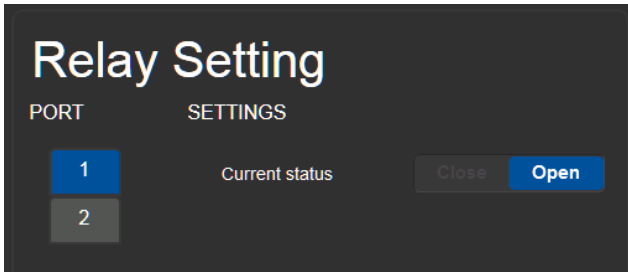

Figure 20: Relay Port Settings Page

The relay ports have the following characteristics:

- Rated at 30V DC and 1A
- Default state of normally open
- A non-latching relay function, that is, the contact is left open when unpowered or on power up state. This means that if a relay is closed and power is lost, the relay returns to its default state. To return it to its pre-power loss state, the setting must be changed using either the Web pages or a P3000 command

To close a relay, (for example, relay 2):

1. On the Relay Setting page, click Port button 2 to select the second relay. The current relay status is shown to the right of the button.
2. Click Close.
The relay closes, the button changes color, and the Relay 2 LED on the front panel lights green.

7.8 IR Command Learner Page

The IR Command Learner page allows you to teach the **FC-28** IR commands. These can be saved for later use. The IR learning commands are in Pronto format.

Note: While learning is in progress, the relevant IR Out LED on the front panel lights and the **FC-28** is not available for normal operation.

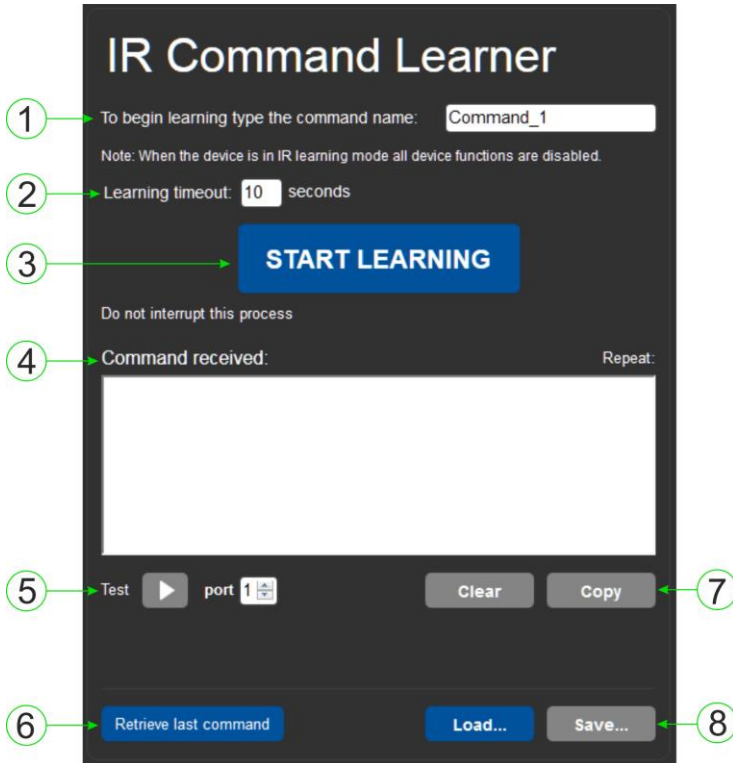

Figure 21: IR Command Learner Page

#	Feature	Function
1	Command Name Field	Enter the required name for the command
2	Learning Timeout	Set the time that will elapse before the learning mode is exited if no command is received
3	Start Learning Button	Press to start the learning process. Note: While learning is in progress, the relevant IR Out LED lights and the FC-28 is not available for normal operation

#	Feature	Function
4	Command Received Window	Displays the command string received during the process. This command can be copied/pasted to another application
5	Test Button and Port Selection Spinner	Select the port on which to test the learned command and press the Test button to start the test
6	Retrieve Last Command Button	Press to retrieve that last command learned
7	Clear/Copy Buttons	Press Clear to erase the current command that has been learned. Press Copy to copy the current command to the clipboard
8	Load/Save Buttons	Press Load to retrieve a previously saved command. Press Save to save the current command

7.9 Security Page

The Security page allows you to turn logon authentication on or off.

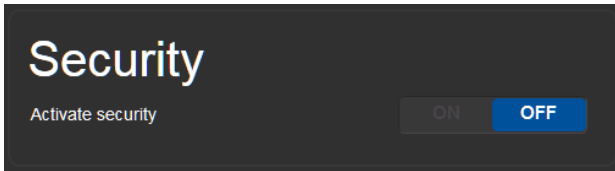

Figure 22: Security Page

When security is on, access to the Web pages is granted only on submission of a valid user and password. For default logon credentials see [Section 10](#).

To activate Web page security:

1. On the Security page, click ON.

The confirmation popup is displayed as shown in [Figure 23](#).

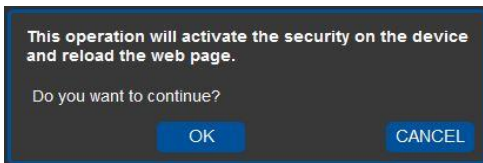

Figure 23: Security Confirmation Popup

2. Click OK.

The Authentication Required popup is displayed as shown in [Figure 24](#).

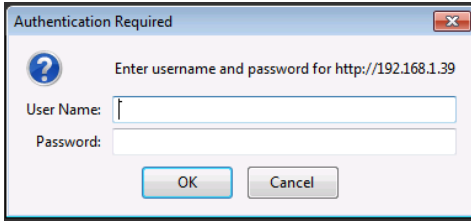

Figure 24: Authentication Required Popup

3. Enter the default username and password.
4. Click OK.
5. Wait until the Web pages have reloaded. Click the Security page button.
The page show in [Figure 25](#) is displayed.

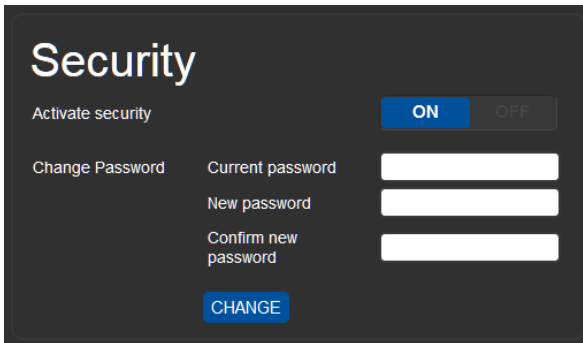

Figure 25: Security Activated Page

6. If required, click OFF to turn security off, or change the password and click Change.

7.10 Logs Page

The Logs page allows you to:

- View current logs
- Configure the logs
- Filter the logs

The log file is updated once per minute.

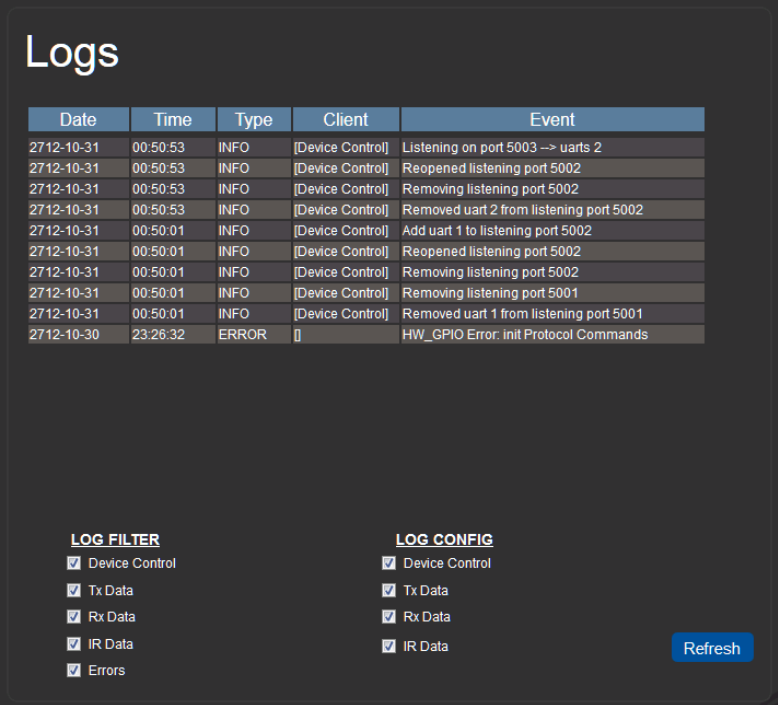

The screenshot shows the 'Logs' page with a table of log entries and two sections for filtering and configuration. The table has columns for Date, Time, Type, Client, and Event. Below the table are two sections: 'LOG FILTER' and 'LOG CONFIG', each with a list of check-boxes. A 'Refresh' button is located at the bottom right of the page.

Date	Time	Type	Client	Event
2712-10-31	00:50:53	INFO	[Device Control]	Listening on port 5003 --> uarts 2
2712-10-31	00:50:53	INFO	[Device Control]	Reopened listening port 5002
2712-10-31	00:50:53	INFO	[Device Control]	Removing listening port 5002
2712-10-31	00:50:53	INFO	[Device Control]	Removed uart 2 from listening port 5002
2712-10-31	00:50:01	INFO	[Device Control]	Add uart 1 to listening port 5002
2712-10-31	00:50:01	INFO	[Device Control]	Reopened listening port 5002
2712-10-31	00:50:01	INFO	[Device Control]	Removing listening port 5002
2712-10-31	00:50:01	INFO	[Device Control]	Removing listening port 5001
2712-10-31	00:50:01	INFO	[Device Control]	Removed uart 1 from listening port 5001
2712-10-30	23:26:32	ERROR	[]	HW_GPIO Error: init Protocol Commands

LOG FILTER

- Device Control
- Tx Data
- Rx Data
- IR Data
- Errors

LOG CONFIG

- Device Control
- Tx Data
- Rx Data
- IR Data

Refresh

Figure 26: Logs Page

The display may not update automatically. Click Refresh to update the display.

Use the Log Filter check-boxes to select which events to display from the log. Use the Log Config check-boxes to select which events are recorded.

7.11 About Us Page

The About Us page displays the Web page version and the Kramer company details.



Figure 27: About Us Page

8 Configuring and Maintaining the FC-28

8.1 IR Learning

Note: While learning is in progress, the relevant IR Out LED lights and the **FC-28** is not available for normal operation.

At the start and end of learning a message is sent to all attached clients.

To perform IR learning, the IR remote control must be approximately five to seven centimeters (2" and 2.7") from the **FC-28** front panel.

To teach the FC-28 an IR command:

1. Put the **FC-28** in IR Learning mode either by sending the P3000 command, (see [Section 11.2](#)) or by using the Web pages, (see [Section 7.8](#)).
The relevant IR Out LED lights, the device is not available for normal operation, and the **FC-28** sends an IR Learning start message to all connected clients.
2. Using the IR remote control, send the required command to the **FC-28**.
The **FC-28** processes the IR signal and generates the Pronto code. When using the Web page for IR learning, the **FC-28** also displays the learned command code on screen. (This command can be copied/pasted to other applications, for example, **K-Touch**, for use when creating a driver.) The **FC-28** then sends the IR Learning stop message to all connected clients to indicate return to normal operation.
3. Optional—Test the command if using the IR Learning Web page.
Test results are displayed on screen.
4. Save the learned command.

8.2 Resetting to the Factory Default Settings

To reset the device to its factory default settings:

1. Turn off the power to the device.
2. Press and hold the Reset button on the rear panel.
3. Turn on the power to the device while holding down the Reset button for a few seconds.
4. Release the button.

The device is reset to the factory default settings.

8.3 Upgrading the Firmware

For instructions on upgrading the firmware see the “*Kramer K-Upload User Manual*”.

9 Technical Specifications

OUTPUTS:	4 IR on four 2-pin terminal blocks
PORTS:	2 RS-232 serial on 3-pin terminal blocks 1 Ethernet on an RJ-45 connector 2 GPI/O ports on 2 2-pin terminal blocks 2 Relay ports on 2 2-pin terminal blocks 1 USB on a mini USB connector for technical service and programming
SUPPORTED SERIAL PORT BAUD RATES:	4800, 9600, 19200, 38400, 57600, 15200bps
RS-232 COMMUNICATION:	Transparent up to 115200bps
IR EMITTER CABLE RANGE:	80m (260ft)
SUPPORTED IR INPUT FREQUENCIES:	20kHz to 60kHz
SUPPORTED IR OUTPUT FREQUENCIES:	20kHz to 1.2MHz
MAXIMUM DATA HANDLING OF DEVICE:	Up to 150kbps (summed on all ports, see Section 9.1)
SUPPORTED WEB BROWSERS:	Windows 7 and higher: <ul style="list-style-type: none"> • Internet Explorer (32/64 bit) version 11 • Firefox version 30 • Chrome version 35 MAC: <ul style="list-style-type: none"> • Chrome version 35 • Firefox version 27 • Safari version 7 Android OS: <ul style="list-style-type: none"> • Chrome version 35 iOS: <ul style="list-style-type: none"> • Chrome version 35 • Safari version 7
POWER CONSUMPTION:	5V DC, 230mA
OPERATING TEMPERATURE:	0° to +40°C (32° to 104°F)
STORAGE TEMPERATURE:	-40° to +70°C (-40° to 158°F)
HUMIDITY:	10% to 90%, RHL non-condensing
COOLING:	Convection
ENCLOSURE TYPE:	Aluminium
RACK MOUNT:	With optional rack adapter
DIMENSIONS:	18.8cm x 12.0cm x 2.5cm (7.4" x 4.72" x 0.98") W, D, H
PRODUCT WEIGHT:	0.45kg (0.99lbs) approx.
SHIPPING WEIGHT:	0.95kg (2.09lbs) approx.
VIBRATION:	ISTA 1A in carton (International Safe Transit Association)
SAFETY REGULATORY COMPLIANCE:	CE
ENVIRONMENTAL REGULATORY COMPLIANCE:	Complies with appropriate requirements of RoHs and WEEE

INCLUDED ACCESSORIES:	Power adapter 5V DC 2A IR Cable C-A35M/IRE-10
OPTIONS:	19" Rack adapter RK-T2B IR Cables—C-A35M/2IRE-10, C-A35M/IRR-3, C-AS35M/AS35F-50, CA35M/IRE-10 Bulk cable for serial, GP I/O, or relay control—BC-1T-300M
Specifications are subject to change without notice at http://www.kramerelectronics.com	

9.1 Data Handling Performance

The **FC-28** is designed to support mainly AV-relevant RS-232 communication.

These devices have overall data bandwidth limits which should be high enough to support the required communication bandwidth in most AV installations.

In extremely demanding cases, we recommend that you take into account the bandwidth limitations.

The total sustained data bandwidth that each device can handle for all ports simultaneously is 150kbps.

9.2 Example Bandwidth Calculation

The **FC-28** has two serial ports. Each serial port can support up to:

- $150\text{kbps} / 2 = 75\text{kbps}$

If each protocol command is 100 bytes, (that is, 800 bits), you can safely send and receive a minimum of 96 commands per second on each serial port. This is shown using the following calculation:

$$(150\text{kbps} * 1024) / 800 \text{ bits} / 2 = 96$$

The same calculation applies to all devices. A similar calculation applies when fewer ports are used at the same time, where a higher bandwidth per port can be achieved.

In critical applications requiring a lossless data transfer, we recommend that communication on all the other ports is stopped when making a long file transfer (for example, when performing a firmware upgrade via one of the serial ports).

9.3 TCP/UDP Port Limitations

Each physical device that connects to the **FC-28** via Ethernet requires two TCP ports, (for example, ports 5001 and 5002). The total number of ports that the **FC-28** can support is 90 TCP and 70 UDP ports. You can therefore connect up to 45 devices to the **FC-28** using TCP. As UDP connections require only a single port per device, you can connect up to 70 devices using UDP.

10 Default Communication Parameters

RS-232 Protocol 3000	
Baud Rate:	115200
Data Bits:	8
Stop Bits:	1
Parity:	None

Note: The **FC-28** is dispatched from the factory with DHCP enabled and a random IP address. After performing a factory reset, the DHCP and the IP address are set to the values shown below.

Ethernet	
DHCP:	Off
IP Address:	192.168.1.39
Host Name:	FC-26-xxxx where xxxx are the last four digits of the serial number of the device
Subnet Mask:	255.255.0.0
Gateway:	192.168.0.1
Maximum Simultaneous Connections:	40
Device TCP Port:	5000
TCP Serial Port 1:	5001
TCP Serial Port 2:	5002
UDP Port:	50000

Default Logon Authentication

Web Page Access	
User name:	Admin
Password:	Admin

11 Kramer Protocol 3000

The **FC-28** can be operated using serial commands from a PC, remote controller or touch screen using the Kramer Protocol 3000.

This section describes:

- Kramer Protocol 3000 syntax (see [Section 11.1](#))
- Kramer Protocol 3000 commands (see [Section 11.2](#))

11.1 Kramer Protocol 3000 – Syntax

11.1.1 Host Message Format

Start	Address (optional)	Body	Delimiter
#	<i>Destination_id@</i>	Message	CR

11.1.1.1 Simple Command

Command string with only one command without addressing:

Start	Body	Delimiter
#	Command SP <i>Parameter_1,Parameter_2,...</i>	CR

11.1.1.2 Command String

Formal syntax with commands concatenation and addressing:

Start	Address	Body	Delimiter
#	<i>Destination_id@</i>	Command_1 <i>Parameter1_1,Parameter1_2,... </i> Command_2 <i>Parameter2_1,Parameter2_2,... </i> Command_3 <i>Parameter3_1,Parameter3_2,... ...</i>	CR

11.1.2 Device Message Format

Start	Address (optional)	Body	delimiter
~	<i>Sender_id@</i>	Message	CR LF

11.1.2.1 Device Long Response

Echoing command:

Start	Address (optional)	Body	Delimiter
~	<i>Sender_id@</i>	Command SP [<i>Param1 ,Param2 ...</i>] result	CR LF

CR = Carriage return (ASCII 13 = 0x0D)

LF = Line feed (ASCII 10 = 0x0A)

SP = Space (ASCII 32 = 0x20)

11.1.3 Command Terms

Command

A sequence of ASCII letters ('A'-'Z', 'a'-'z' and '-').

Command and parameters must be separated by at least one space.

Parameters

A sequence of alphanumeric ASCII characters ('0'-'9','A'-'Z','a'-'z' and some special characters for specific commands). Parameters are separated by commas.

Message string

Every command entered as part of a message string begins with a **message starting character** and ends with a **message closing character**.

Note: A string can contain more than one command. Commands are separated by a pipe ('|') character.

Message starting character

'#' – For host command/query

'~' – For device response

Device address (Optional, for K-NET)

K-NET Device ID followed by '@'

Query sign

'?' follows some commands to define a query request.

Message closing character

CR – For host messages; carriage return (ASCII 13)

CRLF – For device messages; carriage return (ASCII 13) + line-feed (ASCII 10)

Command chain separator character

When a message string contains more than one command, a pipe ('|') character separates each command.

Spaces between parameters or command terms are ignored.

11.1.4 Entering Commands

You can directly enter all commands using a terminal with ASCII communications software, such as HyperTerminal, Hercules, etc. Connect the terminal to the serial or Ethernet port on the Kramer device. To enter **CR** press the Enter key. (**LF** is also sent but is ignored by command parser).

For commands sent from some non-Kramer controllers like Crestron, some characters require special coding (such as, /X##). Refer to the controller manual.

11.1.5 Command Forms

Some commands have short name syntax in addition to long name syntax to allow faster typing. The response is always in long syntax.

11.1.6 Chaining Commands

Multiple commands can be chained in the same string. Each command is delimited by a pipe character (“|”). When chaining commands, enter the **message starting character** and the **message closing character** only once, at the beginning of the string and at the end.

Commands in the string do not execute until the closing character is entered.

A separate response is sent for every command in the chain.

11.1.7 Maximum String Length

64 characters

11.2 Kramer Protocol 3000 – Command List

Command	Description
#	Protocol handshaking
BUILD-DATE?	Read device build date
COM-ROUTE	Set/get tunneling port routing
COM-ROUTE-ADD	Add communication route tunnel connection
COM-ROUTE-REMOVE	Remove communication route tunnel connection
DIR	List files
ETH-PORT	Sets protocol port
ETH-TUNNEL	Get opened tunnel parameters
FACTORY	Restart the machine with the default
FS-FREE?	Print free file space
GET	Get file content
GPIO-CFG	Set/get HW GPIO configuration
GPIO-STATE	Set/get HW GPIO state
GPIO-STEP	Set/get HW GPIO step
GPIO-THR	Set/get HW GPIO threshold voltage
GPIO-VOLT?	Get HW GPIO voltage level
HELP	List of commands
IR-LEARN	Send IR learning command
IR-SND	Send IR command to port
IR-STOP	Stop IR command to port
LOGIN	Set/get protocol permission
LOGOUT	Demotes the terminal security level to minimum
LOG_LEVEL?	Gets current logging level
MACH-NUM	Set device ID
MODEL?	Read device model
NAME	Set/get device (DNS) name
NAME-RST	Reset device name to default
NET-DHCP	Set/get DHCP mode
NET-GATE	Set/get gateway IP
NET-IP	Set/get device IP address
NET-MAC?	Get the MAC address
NET-MASK	Set/get the device subnet mask
PASS	Set/get the password for login level
PROT-VER?	Get protocol version
RELAY-STATE	Set/get relay state
RESET	Reset device
SECUR	Set/get current security state
SN?	Get device serial number
TIME	Set/get the time
TIME-LOC	Set/get local time offset from UTC/GMT
TIME-SRV	Set/get time synchronization from server
UART	Set/get a port serial parameters
VERSION?	Get firmware version number

11.3 Kramer Protocol 3000 – Detailed Commands

This section lists the detailed commands applicable to the **FC-28**.

Command - #		Command Type - System-mandatory	
Command Name		Permission	Transparency
Set:	#	End User	Public
Get:	-	-	-
Description		Syntax	
Set:	Protocol handshaking	# <input type="checkbox"/> CR	
Get:	-	-	
Response			
~ <input type="checkbox"/> <input type="checkbox"/> @ <input type="checkbox"/> SF <input type="checkbox"/> OK <input type="checkbox"/> CR LF			
Parameters			
Response triggers			
Notes			
Use to validate the Protocol 3000 connection and get the machine number			

Command - BUILD-DATE?		Command Type - System-mandatory	
Command Name		Permission	Transparency
Set:	-	-	-
Get:	BUILD-DATE?	End User	Public
Description		Syntax	
Set:	Read device build date	#BUILD-DATE <input type="checkbox"/> CR	
Get:	-	-	
Response			
~ <input type="checkbox"/> <input type="checkbox"/> @BUILD-DATE <input type="checkbox"/> _date <input type="checkbox"/> _time <input type="checkbox"/> CR LF			
Parameters			
<i>date</i> - Format: YYYY/MM/DD where YYYY = Year, MM = Month, DD = Day			
<i>time</i> - Format: hh:mm:ss where hh = hours, mm = minutes, ss = seconds			
Response triggers			
Notes			

Command - COM-ROUTE		Command Type - Communication	
Command Name		Permission	Transparency
Set:	COM-ROUTE	Administrator	Internal
Get:	COM-ROUTE?	End User	Internal
Description		Syntax	
Set:	Set tunneling port routing	# COM-ROUTE _[SP] <i>COM_Num, portType, ETHPort, ETH_rep_en, TCP_keep_alive_timing</i> _[CR]	
Get:	Get tunneling port routing	# COM-ROUTE? _[SP] <i>COM_Num</i> _[CR]	
Response			
~ _[n] @ COM-ROUTE _[SP] <i>COM_Num, portType, ETHPort, ETH_rep_en, TCP_keep_alive_timing</i> _[CR LF]			
Parameters			
<i>COM_Num</i> - 1-2 <i>portType</i> - TCP/UDP <i>ETHPort</i> - TCP/UDP port number <i>ETH_rep_en</i> - 1 - COM port sends replies to new clients. 0 - COM port does not send replies to new clients <i>TCP_keep_alive_timing</i> - 0-360 seconds - every x seconds the device sends an empty string to TCP client ("0")			
Response Triggers			
Notes			
This command sets tunneling port routing. Every com port can send or receive data from the ETH port. All com ports can be configured to the same ETH port.			

Command - COM-ROUTE-ADD		Command Type - Communication	
Command Name		Permission	Transparency
Set:	COM-ROUTE-ADD	Administrator	Internal
Get:	-	-	-
Description		Syntax	
Set:	Add a communication route tunnel connection	# COM-ROUTE-ADD SP	
Get:	-	<i>ComNum,PortType,EthPort,EthRepEn,Timeout</i> CR	
Get:	-	-	
Response			
~ nn @ COM-ROUTE-ADD SP <i>ComNum,PortType,EthPort,EthRepEn,Timeout</i> CR LF			
Parameters			
<i>COM_Num</i> - 1-2			
<i>portType</i> - TCP/UDP			
<i>ETHPort</i> - TCP/UDP port number			
<i>ETH_rep_en</i> - 1 - COM port sends replies to new clients. 0 - COM port does not send replies to new clients			
<i>Timeout</i> - Keep alive timeout in seconds (1 to 360)			
Response Triggers			
Notes			

Command - COM-ROUTE-REMOVE		Command Type - Communication	
Command Name		Permission	Transparency
Set:	COM-ROUTE-REMOVE	Administrator	Internal
Get:	-	-	-
Description		Syntax	
Set:	Remove a communication route tunnel connection	# COM-ROUTE-ADD SP <i>ComNum</i> CR	
Get:	-	-	
Get:	-	-	
Response			
~ nn @ COM-ROUTE-REMOVE SP <i>ComNum</i> CR LF			
Parameters			
<i>COM_Num</i> – UART number 1 to 2			
Response Triggers			
Notes			

Command - DIR		Command Type - File System	
Command Name		Permission	Transparency
Set:	DIR	Administrator	Public
Get:	-	-	-
Description		Syntax	
Set:	List files in device	#DIR _{CR}	
Get:	-	-	
Response			
Multi Line:			
~nn@DIR _{CR LF}			
file_name _{TAB} file_size _{SP} bytes _{SP} ID: _{SP} file_id _{CR LF}			
_{TAB} free_size _{SP} bytes _{CR LF}			
Parameters			
file_name - name of file			
file_size - file size in bytes. A file can take more space on device memory			
file_id - internal ID for file in file system			
free_size - free space in bytes in device file system			
Response Triggers			
Notes			

Command - ETH-PORT		Command Type - Communication	
Command Name		Permission	Transparency
Set:	ETH-PORT	Administrator	Public
Get:	ETH-PORT?	End User	Public
Description		Syntax	
Set:	Set Ethernet port protocol	#ETH-PORT _{SP} portType, ETHPort _{CR}	
Get:	Get Ethernet port protocol	#ETH-PORT? _{SP} portType _{CR}	
Response			
~nn@ ETH-PORT _{SP} portType, ETHPort, portNum _{CR LF}			
Parameters			
portType - TCP/UDP			
ETHPort - TCP/UDP port number			
Response Triggers			
Notes			

Command - ETH-TUNNEL		Command Type - Communication	
Command Name		Permission	Transparency
Set:	-	-	-
Get:	ETH-TUNNEL?	Administrator	Internal
Description		Syntax	
Set:			
Get:	Get an open tunnel parameter	# ETH-TUNNEL? <input type="checkbox"/> <i>TunnelId</i> <input type="checkbox"/>	
Response			
~ <input type="checkbox"/> @ ETH-TUNNEL <input type="checkbox"/> <i>TunnelId,ComNum,PortType,EthPort,EthIp,RemotPort,EthRepEn,Wired</i> <input type="checkbox"/> <input type="checkbox"/>			
Parameters			
<i>TunnelId</i> – tunnel ID number			
<i>ComNum</i> – UART number			
<i>portType</i> – TCP/UDP			
<i>ETHPort</i> – TCP/UDP port number			
<i>EthIp</i> – client IP address			
<i>RemotPort</i> – remote port number			
<i>EthRepEn</i> – 1 = COM port sends replies to new clients. 0 = COM port does not send replies to new clients			
<i>Wired</i> – 1 = wired connection, 0 = not wired connection			
Response Triggers			
Notes			

Command - FACTORY		Command Type - System-mandatory	
Command Name		Permission	Transparency
Set:	FACTORY	End User	Public
Get:	-	-	-
Description		Syntax	
Set:	Reset device to factory defaults configuration	# FACTORY <input type="checkbox"/>	
Get:	-	-	
Response			
~ <input type="checkbox"/> @ BUILD-DATE <input type="checkbox"/> <i>date</i> <input type="checkbox"/> <i>time</i> <input type="checkbox"/> <input type="checkbox"/>			
Parameters			
Response triggers			
Notes			
This command deletes all user data from the device. The deletion can take some time			

Command - FS-FREE?		Command Type - File System	
Command Name		Permission	Transparency
Set:	-	-	-
Get:	FS-FREE?	Administrator	Public
Description		Syntax	
Set:	-	-	
Get:	Get file system free space	# FS-FREE? <input type="checkbox"/> <input type="checkbox"/>	
Response			
~ <input type="checkbox"/> @ FS_FREE <input type="checkbox"/> <i>free_size</i> <input type="checkbox"/>			
Parameters			
<i>free_size</i> - free size in device file system in bytes			
Response Triggers			
Notes			

Command - GET		Command Type - File System	
Command Name		Permission	Transparency
Set:	-	-	-
Get:	GET	Administrator	Public
Description		Syntax	
Set:	-	-	
Get:	Get file	# GET <input type="checkbox"/> <i>file_name</i> <input type="checkbox"/>	
Response			
Multi-line: ~ <input type="checkbox"/> @ GET <input type="checkbox"/> <i>file_name</i> , <i>file_size</i> <input type="checkbox"/> READY <input type="checkbox"/> <i>contents</i> ~ <input type="checkbox"/> @ GET <input type="checkbox"/> <i>file_name</i> <input type="checkbox"/> OK <input type="checkbox"/>			
Parameters			
<i>file_name</i> - name of file to get contents <i>contents</i> - byte stream of file contents <i>file_size</i> - size of file (device sends it in response to give user a chance to get ready)			
Response Triggers			
Notes			

Command – GPIO-CFG		Command Type – HW_GPIO	
Command Name		Permission	Transparency
Set:	GPIO-CFG	End User	Public
Get:	GPIO-CFG?	End User	Public
Description		Syntax	
Set:	Set HW GPIO configuration	#GPIO-CFG _{SP} HwGpioNumber,HwGpioType,HwGpioDir,Pullup _{CR}	
Get:	Get HW GPIO configuration	#GPIO-CFG _{SP} HwGpioNumber _{CR}	
Response			
- _{nn} @GPIO-CFG _{SP} HwGpioNum,HwGpioType,HwGpioDir _{CR LF}			
Parameters			
<i>HwGpioNum</i> – HW GPIO number (1-2)			
<i>HwGpioType</i> – HW GPIO type (0=Analog , 1=Digital)			
<i>HwGpioDir</i> – HW GPIO direction (0=Input , 1=Output)			
<i>Pullup</i> – enable/disable pull-up (0=Disable , 1=Enable)			
Response Triggers			
Notes			

Command – GPIO-STATE		Command Type – HW_GPIO	
Command Name		Permission	Transparency
Set:	GPIO-STATE	End User	Public
Get:	GPIO-STATE?	End User	Public
Description		Syntax	
Set:	Set HW GPIO state	#GPIO-STATE _{SP} HwGpioNumber,HwGpioState _{CR}	
Get:	Get HW GPIO state	#GPIO-STATE _{SP} HwGpioNumber _{CR}	
Response			
- _{nn} @ GPIO-STATE _{SP} HwGpioNum, HwGpioState _{CR LF}			
Parameters			
<i>HwGpioNum</i> – HW GPIO number (1-2)			
<i>HwGpioState</i> – HW GPIO state – See note below			
Response Triggers			
Notes			
<p>GPIO-STATE? can only be sent in digital out mode and the answer is 0=Low , 1=High. In all other modes an error message is sent</p> <p>The device uses this command to notify the user of any change regarding the step:</p> <p>In digital mode the answer is 0=Low , 1=High</p> <p>In analog mode the answer is 0 to 100</p>			

Command – GPIO-STEP		Command Type – HW_GPIO	
Command Name		Permission	Transparency
Set:	GPIO-STEP	End User	Public
Get:	GPIO-STEP?	End User	Public
Description		Syntax	
Set:	Set HW GPIO step	# GPIO-STEP _{SP} <i>HwGpioNumber, Step</i> _{CR}	
Get:	Get HW GPIO step	# GPIO-STEP _{SP} <i>HwGpioNumber</i> _{CR}	
Response			
~ <i>nn</i> @ GPIO-STEP _{SP} <i>HwGpioNumber, NumOfStep, CurrentStep</i> _{CR LF}			
Parameters			
<i>HwGpioNum</i> – HW GPIO number [1-2]			
<i>NumOfStep</i> – the configuration step – See note below			
<i>CurrentStep</i> – the actual step depending on the measured voltage			
Response Triggers			
Notes			
In digital mode the answer is 2			
In analog mode the answer is 1 to 100			
In other modes and error is returned			

Command – GPIO-THR		Command Type – HW_GPIO	
Command Name		Permission	Transparency
Set:	GPIO-THR	End User	Public
Get:	GPIO-THR?	End User	Public
Description		Syntax	
Set:	Set HW GPIO voltage levels	# GPIO-THR _{SP} <i>HwGpioNumber, LowLevel, HighLevel</i> _{CR}	
Get:	Get HW GPIO voltage levels	# GPIO-THR? _{SP} <i>HwGpioNumber</i> _{CR}	
Response			
~ <i>nn</i> @ GPIO-THR _{SP} <i>HwGpioNumber, LowLevel, HighLevel</i> _{CR LF}			
Parameters			
<i>HwGpioNum</i> – HW GPIO number 1-2			
<i>LowLevel</i> – voltage 500 to 28000 millivolts			
<i>HighLevel</i> – voltage 2000 to 30000 millivolts			
Response Triggers			
Notes			

Command – GPIO-VOLT		Command Type – HW_GPIO	
Command Name		Permission	Transparency
Set:	-	-	-
Get:	GPIO-VOLT?	End User	Public
Description		Syntax	
Set:			
Get:	Get HW GPIO voltage levels	GPIO-VOLT? <input type="checkbox"/> <i>HwGpioNumber</i> <input type="checkbox"/>	
Response			
~ <input type="checkbox"/> @GPIO-VOLT <input type="checkbox"/> <i>HwGpioNumber</i> , <i>Voltage</i> <input type="checkbox"/>			
Parameters			
<i>HwGpioNum</i> – HW GPIO number 1-2			
<i>Voltage</i> – voltage 0 to 30000 millivolts			
Response Triggers			
Notes			
This command is not available in digital out mode			

Command - HELP		Command Type - System-mandatory	
Command Name		Permission	Transparency
Set:	-	-	-
Get:	HELP	End User	Public
Description		Syntax	
Set:	-	-	
Get:	Get command list or help for specific command	2 options: 1. #HELP <input type="checkbox"/> 2. #HELP <input type="checkbox"/> <i>command_name</i> <input type="checkbox"/>	
Response			
1. Multi-line: ~ <input type="checkbox"/> @Device available protocol 3000 commands: <input type="checkbox"/> <i>command</i> , <input type="checkbox"/> <i>command...</i> <input type="checkbox"/> To get help for command use: HELP (COMMAND_NAME) <input type="checkbox"/>			
2. Multi-line: ~ <input type="checkbox"/> @HELP <input type="checkbox"/> <i>command:</i> <input type="checkbox"/> <i>description</i> <input type="checkbox"/> USAGE: <i>usage</i> <input type="checkbox"/>			
Parameters			
Response triggers			
Notes			

Command – IR-LEARN		Command Type - IR	
Command Name		Permission	Transparency
Set:	IR-LEARN	End User	Public
Get:	-	-	-
Description		Syntax	
Set:	Send IR learning command	# IR-LEARN _{SP} <i>CommandName,Timeout</i> _{CR}	
Get:	-	-	
Response			
~ _{nn} @ IR-LEARN _{SP} <i>CommandName,IR_Status</i> _{CR LF}			
Parameters			
<i>CommandName</i> – String: IR command name limited to 15 chars. Controlling device must send the correct name (whitespace or commas forbidden) <i>Timeout</i> - Timeout in seconds (1 to 60) <i>IR_Status</i> - (see Section 11.4.4)			
Response Triggers			
Notes			

Command – IR-SND		Command Type - IR	
Command Name		Permission	Transparency
Set:	IR-SND	End User	Public
Get:	-	-	-
Description		Syntax	
Set:	Send IR command to port	#IR-SND <input type="text"/> PortNum, Cmdid, CmdName, Repeat, TotalPackages, PackageNum, ProntoCmdDat <input type="text"/>	
Get:	-	-	
Response			
-hn@IR-SND <input type="text"/> PortNum, Cmdid, CmdName, Status <input type="text"/>			
Parameters			
<p><i>Port_Num</i> – [1..4] IR port transmitting the command. '*' broadcasts to all ports <i>Cmd_id</i> – serial number of command for flow control and response commands from device <i>CommandName</i> – a string, the alias of the IR command. The controlling device is responsible for sending the correct name <i>Repeat</i> – number of times the IR command is transmitted (limited to 50; repeats > 50 are truncated to 50) <i>Total_packages</i> – number of messages the original command was divided into, default = 1 <i>Package_num</i> – chunk serial number (only valid when Chnk_Num >1) <i>Pronto command</i> – Pronto format command (in HEX format, no leading zeros, no '0x' prefix) <i>Status</i> – 0=no error</p>			
Response Triggers			
Notes			

Command – IR-STOP		Command Type - IR	
Command Name		Permission	Transparency
Set:	IR-STOP	End User	Public
Get:	-	-	-
Description		Syntax	
Set:	Send IR stop command to port	#IR-STOP <input type="text"/> PortNum, Cmdid, CmdName <input type="text"/>	
Get:	-	-	
Response			
- <input type="text"/> @IR-STOP <input type="text"/> PortNum, Cmdid, CmdName, Status <input type="text"/>			
Parameters			
<i>Port_Num</i> – [1..4] IR port transmitting the command. '*' broadcasts to all ports <i>Cmd_id</i> – serial number of command for flow control and response commands from device <i>CommandName</i> – a string, the alias of the IR command. The controlling device is responsible for sending the correct name <i>Status</i> – 0=no error			
Response Triggers			
Notes			

Command - LOGIN		Command Type - Authentication	
Command Name		Permission	Transparency
Set:	LOGIN	Not Secure	Public
Get:	LOGIN?	Not Secure	Public
Description		Syntax	
Set:	Set protocol permission	# LOGIN _{SP} login_level,password _{CR}	
Get:	Get current protocol permission level	# LOGIN? _{CR}	
Response			
Set: ~nn@ LOGIN _{SP} login_level,password _{SP} OK _{CR LF}			
or			
~nn@ LOGIN _{SP} ERR _{SP} 004 _{CR LF} (if bad password entered)			
Get: ~nn@ LOGIN _{SP} login_level _{CR LF}			
Parameters			
<i>login_level</i> - level of permissions required (End User or Admin)			
<i>password</i> - predefined password (by PASS command). Default password is an empty string			
Response triggers			
Notes			
For devices that support security, LOGIN allows to the user to run commands with an End User or Administrator permission level			
In each device, some connections can be logged in to different levels and some do not work with security at all			
Connection may logout after timeout			
The permission system works only if security is enabled with the "SECUR" command			

Command - LOGOUT		Command Type - Authentication	
Command Name		Permission	Transparency
Set:	LOGOUT	Not Secure	Public
Get:	-	-	-
Description		Syntax	
Set:	Cancel current permission level	#LOGOUT _{CR}	
Get:	-	-	
Response			
~nn@LOGOUT _{SP} OK _{CR LF}			
Parameters			
Response triggers			
Notes			
Logs out from End User or Administrator permission levels to Not Secure			

Command - MACH-NUM		Command Type - System	
Command Name		Permission	Transparency
Set:	MACH-NUM	End User	Public
Get:	-	-	-
Description		Syntax	
Set:	Set machine number	#MACH-NUM _{SP} machine_number _{CR}	
Get:	-	-	
Response			
~nn@MACH-NUM _{SP} machine_numberOK _{CR LF}			
Parameters			
<i>machine_number</i> - new device machine number			
Response Triggers			
Notes			
Some devices do not set the new machine number until the device is restarted Some devices can change the machine number only from DIP-switches			

Command - MODEL?		Command Type - System-mandatory	
Command Name		Permission	Transparency
Set:	-	-	-
Get:	MODEL?	End User	Public
Description		Syntax	
Set:	-	-	
Get:	Get device model	# MODEL? <input type="checkbox"/> <input type="checkbox"/>	
Response			
~ <input type="checkbox"/> <input type="checkbox"/> @ MODEL <input type="checkbox"/> <i>model_name</i> <input type="checkbox"/> <input type="checkbox"/>			
Parameters			
<i>model_name</i> - String of up to 19 printable ASCII chars			
Response triggers			
Notes			

Command - NAME		Command Type - System (Ethernet)	
Command Name		Permission	Transparency
Set:	NAME	Administrator	Public
Get:	NAME?	End User	Public
Description		Syntax	
Set:	Set machine (DNS) name	# NAME <input type="checkbox"/> <i>machine_name</i> <input type="checkbox"/>	
Get:	Get machine (DNS) name	# NAME? <input type="checkbox"/>	
Response			
Set: ~ <input type="checkbox"/> <input type="checkbox"/> @ NAME <input type="checkbox"/> <i>machine_name</i> <input type="checkbox"/> <input type="checkbox"/> <input type="checkbox"/> <input type="checkbox"/> <input type="checkbox"/>			
Get: ~ <input type="checkbox"/> <input type="checkbox"/> @ NAME? <input type="checkbox"/> <i>machine_name</i> <input type="checkbox"/> <input type="checkbox"/>			
Parameters			
<i>machine_name</i> - String of up to 14 alpha-numeric chars (can include hyphen, not at the beginning or end)			
Response triggers			
Notes			
The machine name is not the same as the model name. The machine name is used to identify a specific machine or a network in use (with DNS feature on)			

Command - NAME-RST		Command Type - System (Ethernet)	
Command Name		Permission	Transparency
Set:	NAME-RST	Administrator	Public
Get:	-	-	-
Description		Syntax	
Set:	Reset machine (DNS) name to factory default	# NAME-RST <input type="checkbox"/>	
Get:	-	-	
Response			
~ <input type="checkbox"/> @ NAME-RST <input type="checkbox"/> <input type="checkbox"/> <input type="checkbox"/> <input type="checkbox"/>			
Parameters			
Response Triggers			
Notes			
Factory default of machine (DNS) name is "KRAMER_" + 4 last digits of device serial number			

Command - NET-DHCP		Command Type - Communication	
Command Name		Permission	Transparency
Set:	NET-DHCP	Administrator	Public
Get:	NET-DHCP?	End User	Public
Description		Syntax	
Set:	Set DHCP mode	# NET-DHCP <input type="checkbox"/> <i>mode</i> <input type="checkbox"/>	
Get:	Get DHCP mode	# NET-DHCP? <input type="checkbox"/>	
Response			
Set: ~ <input type="checkbox"/> @ NET-DHCP <input type="checkbox"/> <i>mode</i> <input type="checkbox"/> <input type="checkbox"/> <input type="checkbox"/> <input type="checkbox"/>			
Get: ~ <input type="checkbox"/> @ NET-DHCP <input type="checkbox"/> <i>mode</i> <input type="checkbox"/>			
Parameters			
<i>mode</i> - 0 - Do not use DHCP. Use the IP set by the factory or using the IP set command 1 - Try to use DHCP. If unavailable, use IP as above			
Response triggers			
Notes			
Connecting Ethernet to devices with DHCP may take more time in some networks To connect with a randomly assigned IP by DHCP, specify the device DNS name (if available) using the command "NAME". You can also get an assigned IP by direct connection to USB or RS-232 protocol port if available For proper settings consult your network administrator			

Command - NET-GATE		Command Type - Communication	
Command Name		Permission	Transparency
Set:	NET-GATE	Administrator	Public
Get:	NET-GATE?	End User	Public
Description		Syntax	
Set:	Set Gateway IP	#NET-GATE _[SP] ip_address _[CR]	
Get:	Get Gateway IP	#NET-GATE? _[CR]	
Response			
Set:	~nn@ NET-GATE _[SP] ip_address _[SP] OK _[CR LF]		
Get:	~nn@ NET-GATE _[SP] ip_address _[CR LF]		
Parameters			
<i>ip_address</i> - format: xxx.xxx.xxx.xxx			
Response triggers			
Notes			
A network gateway connects the device via another network and maybe over the Internet. Be careful of security problems. For proper settings consult your network administrator			

Command - NET-IP		Command Type - Communication	
Command Name		Permission	Transparency
Set:	NET-IP	Administrator	Public
Get:	NET-IP?	End User	Public
Description		Syntax	
Set:	Set device IP address	#NET-IP _[SP] ip_address _[CR]	
Get:	Get device IP address	#NET-IP? _[CR]	
Response			
Set:	~nn@ NET-IP _[SP] ip_address _[SP] OK _[CR LF]		
Get:	~nn@ NET-IP _[SP] ip_address _[CR LF]		
Parameters			
<i>ip_address</i> - format: xxx.xxx.xxx.xxx			
Response triggers			
Notes			
For proper settings consult your network administrator			

Command - NET-MAC?		Command Type - Communication	
Command Name		Permission	Transparency
Set:	-	-	-
Get:	NET-MAC?	End User	Public
Description		Syntax	
Set:			
Get:	Get MAC address	# NET-MAC? _{CR}	
Response			
~ _{nn} @ NET-MAC _{SP} mac_address _{CR LF}			
Parameters			
mac_address - Unique MAC address. Format: XX-XX-XX-XX-XX-XX where X is hex digit			
Response triggers			
Notes			

Command - NET-MASK		Command Type - Communication	
Command Name		Permission	Transparency
Set:	NET-MASK	Administrator	Public
Get:	NET-MASK?	End User	Public
Description		Syntax	
Set:	Set device subnet mask	# NET-MASK _{SP} net_mask _{CR}	
Get:	Get device subnet mask	# NET-MASK? _{CR}	
Response			
Set: ~ _{nn} @ NET-MASK _{SP} net_mask _{SP} OK _{CR LF}			
Get: ~ _{nn} @ NET-MASK _{SP} net_mask _{CR LF}			
Parameters			
net_mask - format: xxx.xxx.xxx.xxx			
Response triggers			
The subnet mask limits the Ethernet connection within the local network For proper settings consult your network administrator			
Notes			

Command - PASS		Command Type - Authentication	
Command Name		Permission	Transparency
Set:	PASS	Administrator	Public
Get:	PASS?	Administrator	Public
Description		Syntax	
Set:	Set password for login level	# PASS _{SP} login_level,password _{CR}	
Get:	Get password for login level	# PASS? _{SP} login_level _{CR}	
Response			
~ nn @ PASS _{SP} login_level,password _{SP} OK _{CR LF}			
Parameters			
<i>login_level</i> - level of login to set (End User or Administrator).			
<i>password</i> - password for the <i>login_level</i> . Up to 15 printable ASCII chars			
Response triggers			
Notes			
The default password is an empty string			

Command - PROT-VER?		Command Type - System-mandatory	
Command Name		Permission	Transparency
Set:	-	-	-
Get:	PROT-VER?	End User	Public
Description		Syntax	
Set:	-	-	
Get:	Get protocol version	# PROT-VER? _{CR}	
Response			
~ nn @ PROT-VER _{SP} 3000:version _{CR LF}			
Parameters			
<i>Version</i> - XX.XX where X is a decimal digit			
Response triggers			
Notes			

Command – RELAY-STATE		Command Type - IR	
Command Name		Permission	Transparency
Set:	RELAY-STATE	End User	Public
Get:	RELAY-STATE?	End User	Public
Description		Syntax	
Set:	Set relay state	# RELAY-STATE _{SP} RelayNumber,RelayState _{CR}	
Get:	Get relay state	# RELAY-STATE? _{SP} RelayNumber _{CR}	
Response			
- nn @ RELAY-STATE _{SP} RelayNum,RelayState _{CR LF}			
Parameters			
<i>RelayNumber</i> – relay number [1-2]			
<i>RelayState</i> – relay state 0=open , 1=close			
Response Triggers			
Notes			

Command - RESET		Command Type - System-mandatory	
Command Name		Permission	Transparency
Set:	RESET	Administrator	Public
Get:	-	-	-
Description		Syntax	
Set:	Reset device	# RESET _{CR}	
Get:	-	-	
Response			
- nn @ RESET _{SP} OK _{CR LF}			
Parameters			
Response triggers			
Notes			
To avoid locking the port due to a USB bug in Windows, disconnect USB connections immediately after running this command. If the port was locked, disconnect and reconnect the cable to reopen the port.			

Command - SECUR		Command Type - Authentication	
Command Name		Permission	Transparency
Set:	SECUR	Administrator	Public
Get:	SECUR?	Not Secure	Public
Description		Syntax	
Set:	Set security	# SECUR _[SP] security_mode _[CR]	
Get:	Get current security state	# SECUR? _[CR]	
Response			
Set:	~ _[nn] @ SECUR _[SP] security_mode _[SP] OK _[CR LF]		
Get:	~ _[nn] @ SECUR _[SP] security_mode _[CR LF]		
Parameters			
security_mode – 1/ON - enables security, 0/OFF - disables security			
Response triggers			
Notes			
The permission system works only if security is enabled with the "SECUR" command			

Command - SN?		Command Type - System-mandatory	
Command Name		Permission	Transparency
Set:	-	-	-
Get:	SN?	End User	Public
Description		Syntax	
Set:	-	-	
Get:	Get serial number	# SN? _[CR]	
Response			
~ _[nn] @ SN _[SP] serial_number _[CR LF]			
Parameters			
serial_number - 11 decimal digits, factory assigned			
Response triggers			
Notes			
For new products with 14 digit serial numbers, use only the last 11 digits			

Command - TIME		Command Type - System	
Command Name		Permission	Transparency
Set:	TIME	Administrator	Public
Get:	TIME?	End User	Public
Description		Syntax	
Set:	Set device time and date	# TIME _{SP} day_of_week,date,time _{CR}	
Get:	Get device time and date	# TIME? _{CR}	
Response			
~nn@ TIME _{SP} day_of_week,date,time _{SP} OK _{CR LF}			
Parameters			
day_of_week - one of {SUN,MON,TUE,WED,THU,FRI,SAT}			
date - Format: DD-MM-YYYY.			
time - Format: hh:mm:ss			
Response triggers			
Notes			
The year must be 4 digits			
The device does not validate the day of week from the date			
Time format - 24 hours			
Date format - Day, Month, Year			

Command - TIME-LOC		Command Type - System	
Command Name		Permission	Transparency
Set:	TIME-LOC	End User	Public
Get:	TIME-LOC?	End User	Public
Description		Syntax	
Set:	Set local time offset from UTC/GMT	# TIME-LOC _{SP} UTC_off,DayLight _{CR}	
Get:	Get local time offset from UTC/GMT	# TIME-LOC? _{CR}	
Response			
~nn@ TIME-LOC _{SP} UTC_off,DayLight _{CR LF}			
Parameters			
UTC_off - Offset of device time from UTC/GMT (without daylight time correction)			
DayLight - 0 - no daylight saving time, 1 - daylight saving time			
Response triggers			
Notes			
If the time server is configured, device time calculates by adding UTC_off to UTC time (that it got from the time server) + 1 hour if daylight savings time is in effect			
TIME command sets the device time without considering these settings			

Command - TIME-SRV		Command Type - System	
Command Name		Permission	Transparency
Set:	TIME-SRV	End User	Public
Get:	TIME-SRV?	End User	Public
Description		Syntax	
Set:	Set time synchronization from server	# TIME-SRV _[SP] <i>mode, srv_ip, sync_hour</i> _[CR]	
Get:	Get time synchronization settings	# TIME-SRV? _[CR]	
Response			
For Set: ~ nn @ TIME-SRV _[SP] <i>mode,srv_ip, sync_hour</i> _[CR LF]			
For Get: ~ nn @ TIME-SRV _[SP] <i>mode,srv_ip,server_status, sync_hour</i> _[CR LF]			
Parameters			
<i>Mode</i> - 0 - disabled, 1 - enabled <i>srv_ip</i> - time server IP address <i>sync_hour</i> - hour in day for time sync <i>server_status</i> - ON/OFF			
Response triggers			
Notes			
Device must have a valid gateway (NTGT command) and DNS server (NTDNS command)			

Command - UART		Command Type - Communication	
Command Name		Permission	Transparency
Set:	UART	Administrator	Public
Get:	UART?	End User	Public
Description		Syntax	
Set:	Set com port configuration	# UART _{SP} COM_Num , <i>baud_rate</i> , <i>data_bit</i> , <i>parity</i> , <i>stop_bit</i> _{CR}	
Get:	Get com port configuration	# UART? _{SP} COM_Num _{CR}	
Response			
Set:	~ nn @ UART _{SP} COM_Num , <i>baud_rate</i> , <i>data_bit</i> , <i>parity</i> , <i>stop_bit</i> _{CR LF}		
Get:	~ nn @ UART _{SP} COM_Num , <i>baud_rate</i> , <i>data_bit</i> , <i>parity</i> , <i>stop_bit</i> , <i>serial1_type</i> , <i>485_term</i> _{CR LF}		
Parameters			
<i>COM_Num</i> - 1-2			
<i>baud_rate</i> - 9600 - 115200			
<i>data_bit</i> - 7-8			
<i>parity</i> - See Section 11.4.1 Parity Types			
<i>stop_bit</i> - 1-2			
<i>serial1_type</i> - 232/485			
<i>485_term</i> - 1/0 (optional - this exists exist only when serial1_type = 485)			
Response triggers			
Notes			
In the FC-2x the serial port is selectable to RS-232 or RS-485 (usually serial port 1). If Serial1 is configured when RS-485 is selected, the RS-485 UART port is automatically changed			

Command - VERSION?		Command Type - System-mandatory	
Command Name		Permission	Transparency
Set:	-	-	-
Get:	VERSION?	End User	Public
Description		Syntax	
Set:	-	-	
Get:	Get firmware version number	# VERSION? _{CR}	
Response			
~ nn @ VERSION? _{SP} <i>firmware_version</i> _{CR LF}			
Parameters			
<i>firmware_version</i> - XX.XX.XXXX where the digit groups are: major.minor.build version			
Response triggers			
Notes			

11.4 Parameters

11.4.1 Parity Types

Number	Value
0	No
1	Odd
2	Even
3	Mark
4	Space

11.4.2 Serial Types

Number	Value
0	232
1	485

11.4.3 IR Transmit Status

Number	Value
0	IR_SENT
1	IR_STOP
2	IR_BUSY
3	IR_WRONG_PARAM
4	IR-NOTHING_TO_STOP

11.4.4 IR Status

Number	Value
0	Sent
1	Stop
2	Done
3	Busy
4	Wrong Parameter
5	Nothing to Stop
6	Start
7	Timeout
8	Error

LIMITED WARRANTY

The warranty obligations of Kramer Electronics for this product are limited to the terms set forth below:

What is Covered

This limited warranty covers defects in materials and workmanship in this product.

What is Not Covered

This limited warranty does not cover any damage, deterioration or malfunction resulting from any alteration, modification, improper or unreasonable use or maintenance, misuse, abuse, accident, neglect, exposure to excess moisture, fire, improper packing and shipping (such claims must be presented to the carrier), lightning, power surges, or other acts of nature. This limited warranty does not cover any damage, deterioration or malfunction resulting from the installation or removal of this product from any installation, any unauthorized tampering with this product, any repairs attempted by anyone unauthorized by Kramer Electronics to make such repairs, or any other cause which does not relate directly to a defect in materials and/or workmanship of this product. This limited warranty does not cover cartons, equipment enclosures, cables or accessories used in conjunction with this product.

Without limiting any other exclusion herein, Kramer Electronics does not warrant that the product covered hereby, including, without limitation, the technology and/or integrated circuit(s) included in the product, will not become obsolete or that such items are or will remain compatible with any other product or technology with which the product may be used.

How Long Does this Coverage Last

Seven years as of this printing; please check our Web site for the most current and accurate warranty information.

Who is Covered

Only the original purchaser of this product is covered under this limited warranty. This limited warranty is not transferable to subsequent purchasers or owners of this product.

What Kramer Electronics will do

Kramer Electronics will, at its sole option, provide one of the following three remedies to whatever extent it shall deem necessary to satisfy a proper claim under this limited warranty:

1. Elect to repair or facilitate the repair of any defective parts within a reasonable period of time, free of any charge for the necessary parts and labor to complete the repair and restore this product to its proper operating condition. Kramer Electronics will also pay the shipping costs necessary to return this product once the repair is complete.
2. Replace this product with a direct replacement or with a similar product deemed by Kramer Electronics to perform substantially the same function as the original product.
3. Issue a refund of the original purchase price less depreciation to be determined based on the age of the product at the time remedy is sought under this limited warranty.

What Kramer Electronics will not do Under This Limited Warranty

If this product is returned to Kramer Electronics or the authorized dealer from which it was purchased or any other party authorized to repair Kramer Electronics products, this product must be insured during shipment, with the insurance and shipping charges prepaid by you. If this product is returned uninsured, you assume all risks of loss or damage during shipment. Kramer Electronics will not be responsible for any costs related to the removal or re-installation of this product from or into any installation. Kramer Electronics will not be responsible for any costs related to any setting up this product, any adjustment of user controls or any programming required for a specific installation of this product.

How to Obtain a Remedy under this Limited Warranty

To obtain a remedy under this limited warranty, you must contact either the authorized Kramer Electronics reseller from whom you purchased this product or the Kramer Electronics office nearest you. For a list of authorized Kramer Electronics resellers and/or Kramer Electronics authorized service providers, please visit our web site at www.kramerelectronics.com or contact the Kramer Electronics office nearest you.

In order to pursue any remedy under this limited warranty, you must possess an original, dated receipt as proof of purchase from an authorized Kramer Electronics reseller. If this product is returned under this limited warranty, a return authorization number, obtained from Kramer Electronics, will be required. You may also be directed to an authorized reseller or a person authorized by Kramer Electronics to repair the product.

If it is decided that this product should be returned directly to Kramer Electronics, this product should be properly packed, preferably in the original carton, for shipping. Cartons not bearing a return authorization number will be refused.

Limitation on Liability

THE MAXIMUM LIABILITY OF KRAMER ELECTRONICS UNDER THIS LIMITED WARRANTY SHALL NOT EXCEED THE ACTUAL PURCHASE PRICE PAID FOR THE PRODUCT. TO THE MAXIMUM EXTENT PERMITTED BY LAW, KRAMER ELECTRONICS IS NOT RESPONSIBLE FOR DIRECT, SPECIAL, INCIDENTAL OR CONSEQUENTIAL DAMAGES RESULTING FROM ANY BREACH OF WARRANTY OR CONDITION, OR UNDER ANY OTHER LEGAL THEORY. Some countries, districts or states do not allow the exclusion or limitation of relief, special, incidental, consequential or indirect damages, or the limitation of liability to specified amounts, so the above limitations or exclusions may not apply to you.

Exclusive Remedy

TO THE MAXIMUM EXTENT PERMITTED BY LAW, THIS LIMITED WARRANTY AND THE REMEDIES SET FORTH ABOVE ARE EXCLUSIVE AND IN LIEU OF ALL OTHER WARRANTIES, REMEDIES AND CONDITIONS, WHETHER ORAL OR WRITTEN, EXPRESS OR IMPLIED. TO THE MAXIMUM EXTENT PERMITTED BY LAW, KRAMER ELECTRONICS SPECIFICALLY DISCLAIMS ANY AND ALL IMPLIED WARRANTIES, INCLUDING, WITHOUT LIMITATION, WARRANTIES OF MERCHANTABILITY AND FITNESS FOR A PARTICULAR PURPOSE. IF KRAMER ELECTRONICS CANNOT LAWFULLY DISCLAIM OR EXCLUDE IMPLIED WARRANTIES UNDER APPLICABLE LAW, THEN ALL IMPLIED WARRANTIES COVERING THIS PRODUCT, INCLUDING WARRANTIES OF MERCHANTABILITY AND FITNESS FOR A PARTICULAR PURPOSE, SHALL APPLY TO THIS PRODUCT AS PROVIDED UNDER APPLICABLE LAW.

IF ANY PRODUCT TO WHICH THIS LIMITED WARRANTY APPLIES IS A "CONSUMER PRODUCT" UNDER THE MAGNUSON-MOSS WARRANTY ACT (15 U.S.C.A. §2301, ET SEQ.) OR OTHER APPLICABLE LAW, THE FOREGOING DISCLAIMER OF IMPLIED WARRANTIES SHALL NOT APPLY TO YOU, AND ALL IMPLIED WARRANTIES ON THIS PRODUCT, INCLUDING WARRANTIES OF MERCHANTABILITY AND FITNESS FOR THE PARTICULAR PURPOSE, SHALL APPLY AS PROVIDED UNDER APPLICABLE LAW.

Other Conditions

This limited warranty gives you specific legal rights, and you may have other rights which vary from country to country or state to state.

This limited warranty is void if (i) the label bearing the serial number of this product has been removed or defaced, (ii) the product is not distributed by Kramer Electronics or (iii) this product is not purchased from an authorized Kramer Electronics reseller. If you are unsure whether a reseller is an authorized Kramer Electronics reseller, please visit our Web site at www.kramerelectronics.com or contact a Kramer Electronics office from the list at the end of this document.

Your rights under this limited warranty are not diminished if you do not complete and return the product registration form or complete and submit the online product registration form. Kramer Electronics thanks you for purchasing a Kramer Electronics product. We hope it will give you years of satisfaction.



For the latest information on our products and a list of Kramer distributors, visit our Web site where updates to this user manual may be found.

We welcome your questions, comments, and feedback.

Web site: www.kramerelectronics.com

E-mail: info@kramerel.com



SAFETY WARNING

Disconnect the unit from the power supply before opening and servicing



P/N: 2900-306539



Rev: 1