

# EPSON

## User's Guide

### Multimedia Projector

<b>EB-L890E</b>	<b>EB-L890U</b>
<b>EB-L895E</b>	<b>EB-L895U</b>
<b>EB-L790SE</b>	<b>EB-L790U</b>
<b>EB-L795SE</b>	<b>EB-L790SU</b>
<b>EB-L690SE</b>	<b>EB-L690U</b>
<b>EB-L695SE</b>	<b>EB-L690SU</b>
<b>EB-L690E</b>	<b>EB-L695SU</b>

## **Notations Used in This Guide** **8**

---

### **Using the Manual to Search for Information** ..... 9

- Searching by Keyword ..... 9
- Jumping Directly from Bookmarks ..... 9
- Printing Only the Pages You Need ..... 9

### **Getting the Latest Version of the Documents** ..... 10

## **List of Functions** **11**

---

## **Introduction to Your Projector** **15**

---

### **Projector Features** ..... 16

- Quick and Easy Setup ..... 16
- 4K Enhancement Technology to Project Even More Information Crisply and Cleanly ..... 16
- Quick and Easy Multi-projection Setup ..... 16
- Install in a Variety of Environments ..... 16
- Easy Wireless Projection ..... 16
- Linking with Apple Devices ..... 17
- Environmentally-Friendly ..... 18

### **Projector Parts and Functions** ..... 19

- Projector Parts - Front/Top ..... 19
- Projector Parts - Rear ..... 20
- Projector Parts - Base ..... 21
- Projector Parts - Interface Ports ..... 22
- Projector Parts - Control Panel ..... 23
- Projector Parts - Remote Control ..... 24

## **Setting Up the Projector** **26**

---

### **Projector Placement** ..... 27

- Notes on Transporting ..... 29

- Projector Setup and Installation Options ..... 29
  - Precautions on Installation ..... 29
  - Projection Distance ..... 31

### **Installing the Safety Wire** ..... 32

- When Using the Ceiling Mount ELPMB22 ..... 32
- When Using the Ceiling Mount ELPMB30 ..... 33

### **Projector Connections** ..... 35

- Connecting to a Computer ..... 35
  - Connecting to a Computer for HDMI Video and Audio ..... 35
- Connecting to Video Sources ..... 35
  - Connecting to an HDMI Video Source ..... 36
- Connecting to External USB Devices ..... 36
  - USB Device Projection ..... 36
  - Connecting to a USB Device ..... 37
  - Disconnecting a USB Device ..... 37
- Connecting to a Document Camera ..... 37
- Connecting to an HDBaseT Transmitter ..... 37
- Connecting to the Base Unit ..... 38
- Connecting to External Devices ..... 39
  - Connecting to an External HDMI Monitor ..... 39
  - Connecting to External Speakers ..... 39

### **Connecting Multiple Projectors of the Same Model** ..... 41

- Projecting the Same Image in a Daisy-Chain Connection ..... 41

### **Attaching and Removing the Cable Cover** ..... 43

### **Installing Batteries in the Remote Control** ..... 44

- Remote Control Operation ..... 45

## **Using Basic Projector Features** **46**

---

### **Turning On the Projector** ..... 47

- Home Screen ..... 48

### **Turning Off the Projector** ..... 50

<b>Setting the Date and Time .....</b>	<b>51</b>	<b>Adjusting the Image Color .....</b>	<b>84</b>
<b>Selecting the Language for the Projector Menus .....</b>	<b>53</b>	Adjusting the Hue, Saturation, and Brightness .....	84
<b>Projection Modes .....</b>	<b>54</b>	Adjusting the Gamma .....	85
Changing the Projection Mode Using the Remote Control .....	54	<b>Adjusting the Image Resolution .....</b>	<b>87</b>
Changing the Projection Mode Using the Menus .....	54	<b>Adjusting the Brightness .....</b>	<b>89</b>
<b>Setting the Screen Type .....</b>	<b>56</b>	Light Source Operation Time .....	90
Adjusting the Image Position Using Screen Position .....	56	<b>Controlling the Volume with the Volume Buttons .....</b>	<b>92</b>
Changing the Horizontal Position of the Image Using Screen Shift .....	57	<b>Adjusting Projector Features .....</b>	<b>93</b>
<b>Adjusting the Image Position Using Lens Shift .....</b>	<b>59</b>	<hr/>	
<b>Displaying a Test Pattern .....</b>	<b>60</b>	<b>HDMI Link Features .....</b>	<b>94</b>
<b>Adjusting the Image Height .....</b>	<b>61</b>	Operating the Connected Devices Using the HDMI Link Features .....	94
<b>Image Shape .....</b>	<b>62</b>	<b>Projecting Two Images Simultaneously .....</b>	<b>96</b>
Correcting Image Shape with H/V Keystone .....	62	Input Sources for Split Screen Projection .....	97
Correcting the Image Shape with Quick Corner .....	63	Split Screen Projection Restrictions .....	98
Correcting Image Shape with Curved Surface Mode .....	66	<b>Projecting a PC Free Presentation .....</b>	<b>99</b>
Correcting Image Shape with Corner Wall Mode .....	68	Supported PC Free File Types .....	99
Correcting Image Shape with Point Correction Mode .....	71	Precautions on PC Free Projection .....	99
Loading Image Shape Setting from Memory .....	74	Starting a PC Free Slide Show .....	100
<b>Resizing the Image with the Zoom Ring .....</b>	<b>75</b>	Starting a PC Free Movie Presentation .....	101
<b>Focusing the Image Using the Focus Ring .....</b>	<b>76</b>	PC Free Display Options .....	102
<b>Focusing the Image Using the Focus Ring (Center/Corner) .....</b>	<b>77</b>	<b>Projecting in Content Playback Mode .....</b>	<b>104</b>
<b>Selecting an Image Source .....</b>	<b>78</b>	Supported Content Playback Mode File Types .....	104
<b>Image Aspect Ratio .....</b>	<b>80</b>	Switching to Content Playback Mode .....	104
Changing the Image Aspect Ratio .....	80	Projecting Your Playlists .....	105
Available Image Aspect Ratios .....	81	Creating Playlists Using Epson Web Control .....	106
<b>Adjusting Image Quality (Color Mode) .....</b>	<b>82</b>	Adding Effects to Your Projected Image .....	108
Changing the Color Mode .....	82	Content Playback Mode Restrictions .....	109
Available Color Modes .....	82	<b>Shutting Off the Image and Sound Temporarily .....</b>	<b>110</b>
<b>Turning On Automatic Luminance Adjustment .....</b>	<b>83</b>	<b>Stopping Video Action Temporarily .....</b>	<b>111</b>
		<b>Turning Off the Sound Temporarily (Mute) .....</b>	<b>112</b>

- Zooming Images (E-Zoom) ..... 113**
- Saving a User's Logo Image ..... 114**
- Saving Settings to Memory and Using Saved Settings ..... 116**
- Using Advanced Image Adjustment Features ..... 117**
  - Adjusting the Color Tone (Color Uniformity) ..... 117
  - Running Light Source Calibration ..... 118
- Multi-Projection Features ..... 120**
  - Conditions for the Camera Correction Function ..... 120
  - Procedure Overview ..... 120
  - Preparing for Multi-Projection ..... 121
    - Connecting Projectors ..... 121
    - Initializing Projectors ..... 121
    - Assigning a Primary Projector ..... 121
    - Calibrating Projectors ..... 122
    - Installing Projectors ..... 122
    - Performing Rough Image Adjustments ..... 122
    - Connecting Projectors to a Network ..... 122
  - Image Composition ..... 123
    - Blending Using the Epson Projector Professional Tool Software and the Optional Camera ..... 123
    - Tiling Using the Projector's Menu ..... 124
    - Simple Blending Using the Projector's Menu and the Optional External Camera ..... 128
    - Stacking Using the Epson Projector Professional Tool Software and the Optional Camera ..... 129
    - Stacking Using the Projector's Menu (Simple Stacking) ..... 129
    - Stacking & Blending Using the Epson Projector Professional Tool Software ..... 130
  - Adjusting Colors ..... 130
- External Camera Usage ..... 131**
  - Connecting to an Optional Camera ..... 131
- Projector Security Features ..... 133**
  - Password Security Types ..... 133
    - Setting a Password ..... 133
    - Selecting Password Security Types ..... 134

- Entering a Password to Use the Projector ..... 135
- Locking the Projector's Buttons ..... 135
  - Unlocking the Projector's Buttons ..... 136
- Locking the Remote Control Buttons ..... 136
- Installing a Security Cable ..... 137

## **Using the Projector on a Network ..... 138**

- Wired Network Projection ..... 139**
  - Connecting to a Wired Network ..... 139
  - Selecting Wired Network Settings ..... 139
- Wireless Network Projection ..... 143**
  - Safety Instructions for Built-in Wireless LAN Module ..... 143
  - Installing the Wireless LAN Module ..... 143
  - Connection Methods for Wireless Network Projection ..... 144
  - Selecting Wireless Network Settings Manually ..... 145
    - Selecting Wireless Network Settings in Windows ..... 148
    - Selecting Wireless Network Settings in Mac ..... 148
  - Setting Up Wireless Network Security (When Simple AP is Enabled) ..... 148
  - Setting Up Wireless Network Security (When Simple AP is Disabled) ..... 149
    - Supported Client and CA Certificates ..... 150
  - Using a QR Code to Connect a Mobile Device ..... 151
  - Using a USB Key to Connect a Windows Computer ..... 152
- Wireless Network Projection from a Mobile Device (Miracast) .... 153**
  - Selecting Miracast Settings ..... 153
  - Connecting with the Miracast Function ..... 154
  - Connecting Using Miracast in Windows 10 ..... 155
  - Connecting Using Miracast in Windows 11 ..... 156
- Using AirPlay ..... 157**
  - Settings for AirPlay ..... 157
  - Streaming/Mirroring Media with an AirPlay Connection ..... 159
- Secure HTTP ..... 161**
  - Importing a Web Server Certificate Using the Menus ..... 161
    - Supported Web Server Certificates ..... 162

<b>Screen Sharing .....</b>	<b>163</b>
Sharing the Screen .....	163
Finishing the Screen Sharing .....	164
Receiving Shared Screen Images .....	165

## **Monitoring and Controlling the Projector 166**

---

<b>Epson Projector Management Connected/Epson Projector Management .....</b>	<b>167</b>
--	------------

<b>Controlling a Networked Projector Using a Web Browser .....</b>	<b>168</b>
Web Control Options .....	170

<b>Registering Digital Certificates from a Web Browser .....</b>	<b>177</b>
--	------------

<b>Setting Up Projector Network E-Mail Alerts .....</b>	<b>179</b>
Network Projector E-mail Alert Messages .....	179

<b>Setting Up Monitoring Using SNMP .....</b>	<b>180</b>
---	------------

<b>Using ESC/VP21 Commands .....</b>	<b>182</b>
ESC/VP21 Command List .....	182
Cable Layouts .....	182

<b>PJLink Support .....</b>	<b>183</b>
-----------------------------	------------

<b>Crestron Connected Support .....</b>	<b>184</b>
Setting Up Crestron Connected Support .....	184

<b>Operating the Projector Using Web API .....</b>	<b>186</b>
Enabling Web API .....	186

<b>Setting Projector Event Schedules .....</b>	<b>187</b>
--	------------

## **Adjusting the Menu Settings 190**

---

<b>Using the Projector's Menus .....</b>	<b>191</b>
--	------------

<b>Using the Displayed Keyboard .....</b>	<b>192</b>
---	------------

Available Text Using the Displayed Keyboard .....	192
---	-----

<b>Image Quality Settings - Image Menu .....</b>	<b>193</b>
--	------------

<b>Input Signal Settings - Signal I/O Menu .....</b>	<b>196</b>
--	------------

<b>Projector Installation Settings - Installation Menu .....</b>	<b>198</b>
--	------------

<b>Multiple Projector Operation Settings - Multi-Projection Menu .....</b>	<b>200</b>
--	------------

<b>Projector Display Settings - Display Menu .....</b>	<b>202</b>
--	------------

<b>Projector Feature Settings - Operation Menu .....</b>	<b>204</b>
Functions Available in Standby Mode .....	206

<b>Projector Administration Settings - Management Menu .....</b>	<b>207</b>
Event ID Code List .....	208

<b>Projector Network Settings - Network Menu .....</b>	<b>211</b>
Network Menu - Network Settings Menu .....	212
Network Menu - Wireless LAN Menu .....	214
Network Menu - Wired LAN Menu .....	216
Network Menu - Mail Notification Menu .....	216
Network Menu - Projector Control Menu .....	217
Network Menu - Network Projection Settings .....	219

<b>Projector Information Display - Info Menu .....</b>	<b>222</b>
--	------------

<b>Image Quality Memory Settings - Memory Menu .....</b>	<b>223</b>
--	------------

<b>Projector Setup Settings - ECO Menu .....</b>	<b>224</b>
--	------------

<b>Projector Initial Settings and Reset Options - Initial/All Settings Menu .....</b>	<b>225</b>
---	------------

<b>Copying Menu Settings Between Projectors (Batch Setup) .....</b>	<b>227</b>
Transferring Settings From a USB Flash Drive .....	227
Transferring Settings From a Computer .....	228
Batch Setup Error Notification .....	229

## **Maintaining the Projector 230**

- Projector Maintenance .....231**
- Cleaning the Lens ..... 232**
- Cleaning the Projector Case ..... 233**
- Air Filter and Vent Maintenance .....234**
  - Cleaning the Air Filters and Intake Vents ..... 234
  - Replacing the Air Filter ..... 236
- Updating the Firmware ..... 238**
  - Updating Firmware Using a USB Storage Device .....238
  - Updating the Firmware over the Network ..... 240

## **Solving Problems 242**

- Projection Problems .....243**
- Projector Indicator Status .....244**
- Viewing the Status Display .....247**
- Solving Image or Sound Problems .....248**
  - Solutions When No Image Appears ..... 248
  - Solutions When "No Signal" Message Appears .....248
    - Displaying From a Windows Laptop ..... 249
    - Displaying From a Mac Laptop .....249
  - Solutions When "Not Supported" Message Appears .....249
  - Solutions When Only a Partial Image Appears ..... 250
  - Solutions When the Image Contains Noise or Static ..... 250
  - Solutions When the Image is Fuzzy or Blurry ..... 251
  - Solutions When the Image is not Rectangular ..... 251
  - Solutions When the Image Brightness or Colors are Incorrect ..... 251
  - Solutions When Automatic Adjustments are not Applied Correctly ..... 252
  - Solutions When Simple Stacking is not Applied Correctly .....253
  - Solutions When Simple Blending is not Applied Correctly ..... 253
  - Solutions When an Afterimage Remains on the Projected Image ..... 253

- Solutions to Sound Problems .....253
- Solutions When Image File Names are not Displayed Correctly in PC Free ..... 254
- Solutions When You Cannot Project Images Using the PC Free Feature .....254

## **Solving Projector or Remote Control Operation Problems .....255**

- Solutions to Projector Power or Shut-Off Problems ..... 255
- Solutions to Problems with the Remote Control ..... 255
- Solutions to Password Problems .....256
- Solution When "The Battery that Saves Your Clock Settings is Running Low" Message Appears .....256

## **Solving Network Problems ..... 257**

- Solutions When Wireless Authentication Fails .....257
- Solutions When You Cannot Access the Projector Through the Web .....257
- Solutions When Network Alert E-Mails are not Received .....258
- Solutions When the Image Contains Static During Network Projection ..... 258
- Solutions When You Cannot Connect Using Miracast ..... 258
- Solutions When the Image or Sound Contains Static During Miracast Connection ..... 259
- Solutions When You Cannot Connect Using AirPlay ..... 259
- Solutions When the Image or Sound Contains Static During AirPlay Connection ..... 259
- Solutions When You Cannot Receive Shared Images ..... 259

## **Solutions to Problems in Content Playback Mode .....261**

## **Solutions When HDMI Link does not Function ..... 262**

## **Appendix 263**

### **Optional Accessories and Replacement Parts .....264**

- Screens ..... 264
- Mounts ..... 264
  - For Wireless Connection ..... 264
- External Devices ..... 265
- Replacement Parts ..... 265

### **Screen Size and Projection Distance .....266**

### **Supported Monitor Display Resolutions ..... 274**



<b>Projector Specifications .....</b>	<b>275</b>
Connector Specifications .....	277
<b>External Dimensions .....</b>	<b>278</b>
<b>Supported Features for Epson Projector Content Manager .....</b>	<b>281</b>
<b>List of Safety Symbols and Instructions .....</b>	<b>282</b>
<b>Laser Safety Information .....</b>	<b>284</b>
Laser Warning Labels .....	284
<b>Notices .....</b>	<b>286</b>
FCC Compliance Statement .....	286
Indication of the manufacturer and the importer in accordance with requirements of EU directive .....	287
TCO Information .....	287
Restriction of Use .....	288
Operating System References .....	288
Trademarks .....	288
Copyright Notice .....	289
Copyright Attribution .....	289

# Notations Used in This Guide



## Safety Symbols

The projector and its manuals use graphical symbols and labels to indicate content that tells you how to use the projector safely.

Read and carefully follow the instructions that are marked with these symbols and labels to avoid injury to persons or damage to property.

 <b>Warning</b>	This symbol indicates information that, if ignored, could possibly result in personal injury or even death.
 <b>Caution</b>	This symbol indicates information that, if ignored, could possibly result in personal injury or physical damage due to incorrect handling.

## General Information Notations

<b>Attention</b>	This label indicates procedures that may result in damage or injury if sufficient care is not taken.
	This label indicates additional information that may be useful to know.
[Button name]	Indicates the name of the buttons on the remote control or the control panel. Example: [Esc] button
Menu/Setting name	Indicates projector menu and setting names. Example: Select the <b>Image</b> menu  <b>Image &gt; Color Mode</b>
»»	This label indicates links to the related pages.
	This label indicates the projector's current menu level.

## »» Related Links

- "Using the Manual to Search for Information" [p.9](#)
- "Getting the Latest Version of the Documents" [p.10](#)



The PDF manual allows you to search for information you are looking for by keyword, or jump directly to specific sections using the bookmarks. You can also print only the pages you need. This section explains how to use a PDF manual that has been opened in Adobe Reader X on your computer.

### ► Related Links

- "Searching by Keyword" p.9
- "Jumping Directly from Bookmarks" p.9
- "Printing Only the Pages You Need" p.9

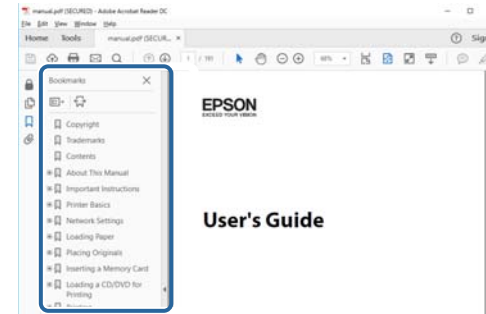

## Searching by Keyword

Click **Edit > Advanced Search**. Enter the keyword (text) for information you want to find in the search window, and then click **Search**. Hits are displayed as a list. Click one of the displayed hits to jump to that page.

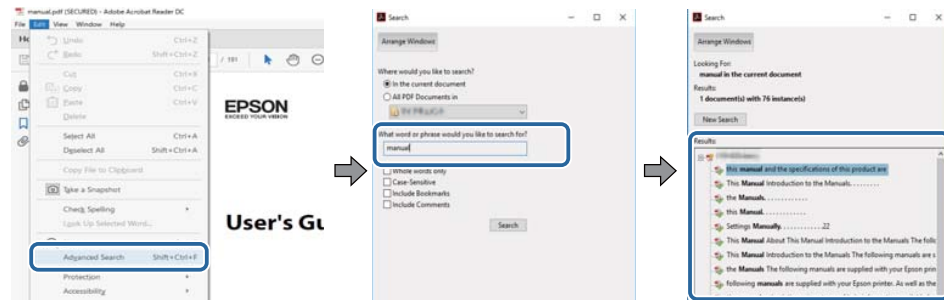

## Printing Only the Pages You Need

You can extract and print only the pages you need. Click **Print** in the **File** menu, and then specify the pages you want to print in **Pages in Pages to Print**.

- To specify a series of pages, enter a hyphen between the start page and the end page.  
Example: 20-25
- To specify pages that are not in series, divide the pages with commas.  
Example: 5, 10, 15

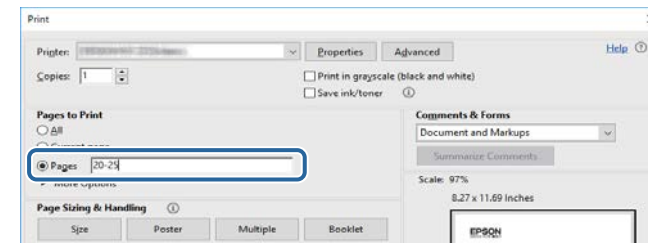

## Jumping Directly from Bookmarks

Click a title to jump to that page. Click + or > to view the lower level titles in that section. To return to the previous page, perform the following operation on your keyboard.

- Windows: Hold down **Alt**, and then press **←**.
- Mac OS: Hold down the command key, and then press **←**.

You can get the latest version of the manuals and specifications on the Epson Web site.

Visit [epson.sn](http://epson.sn), and enter your model name.





	EB-L890E/EB-L895E	EB-L790SE/EB-L795SE	EB-L690SE/EB-L695SE	EB-L690E	EB-L890U/EB-L895U	EB-L790U	EB-L790SU	EB-L690U	EB-L690SU/EB-L695SU
Mail Notification	✓	✓	✓	✓	✓	✓	✓	✓	✓
SNMP	✓	✓	✓	✓	✓	✓	✓	✓	✓
Secure HTTP (HTTPS)	✓	✓	✓	✓	✓	✓	✓	✓	✓
ESC/VP21 Commands	✓	✓	✓	✓	✓	✓	✓	✓	✓
ESC/VP.net (Ver. 2.0)	✓	✓	✓	✓	✓	✓	✓	✓	✓
Web API	✓	✓	✓	✓	✓	✓	✓	✓	✓
PJLink	✓	✓	✓	✓	✓	✓	✓	✓	✓
Crestron Integrated Partner	✓	✓	✓	✓	✓	✓	✓	✓	✓
Extron IP Link	✓	✓	✓	✓	✓	✓	✓	✓	✓
Extron XTP	✓	✓	✓	✓	✓	✓	✓	✓	✓
AMX Device Discovery	✓	✓	✓	✓	✓	✓	✓	✓	✓
Control4 Simple Device Discovery Protocol	✓	✓	✓	✓	✓	✓	✓	✓	✓
Crestron Connected	✓	✓	✓	✓	✓	✓	✓	✓	✓
4K Enhancement	✓	✓	✓	✓	-	-	-	-	-
Firmware update using USB-A (5V===900mA) port (USB flash drive)	✓	✓	✓	✓	✓	✓	✓	✓	✓
Firmware update using USB-A (5V===2.0A) port (USB flash drive)	-	-	✓	-	-	-	-	-	-
Firmware update over network	✓	✓	-	✓	✓	✓	✓	✓	✓
Wireless LAN Diagnosis	-	-	✓	-	-	-	-	-	-
Wireless LAN system (Wi-Fi4/5)	-	-	✓	-	-	-	-	-	-
Auto Configuration	-	-	✓	-	-	-	-	-	-

	EB-L890E/EB-L895E	EB-L790SE/EB-L795SE	EB-L690SE/EB-L695SE	EB-L690E	EB-L890U/EB-L895U	EB-L790U	EB-L790SU	EB-L690U	EB-L690SU/EB-L695SU
Use Temporary Address	-	-	✓	-	-	-	-	-	-
Wireless Presentation System (ELPWP20)	✓	✓	-	✓	✓	✓	✓	✓	✓

# Introduction to Your Projector

Refer to these sections to learn more about your projector's features and part names.

## ▶ Related Links

- "Projector Features" [p.16](#)
- "Projector Parts and Functions" [p.19](#)

This projector comes with these special features. Refer to these sections for more details.

## ► Related Links

- "Quick and Easy Setup" [p.16](#)
- "4K Enhancement Technology to Project Even More Information Crisply and Cleanly" [p.16](#)
- "Quick and Easy Multi-projection Setup" [p.16](#)
- "Install in a Variety of Environments" [p.16](#)
- "Easy Wireless Projection" [p.16](#)
- "Linking with Apple Devices" [p.17](#)
- "Environmentally-Friendly" [p.18](#)

## Quick and Easy Setup

You can easily make projector settings using NFC technology.

## 4K Enhancement Technology to Project Even More Information Crisply and Cleanly

- The high resolution of 4K enhancement technology allows you to display more information than when using WUXGA or Full HD.
- High brightness realizes crisp, clean images even in bright environments.
- The high color reproducibility of 3LCD technology allows you to experience images rich with color.

## Quick and Easy Multi-projection Setup

- When using multiple projectors, you can attach an optional external camera to automatically compensate for unevenness in brightness and color that occur due to installation and the passage of time.
- Epson Projector Professional Tool allows you to quickly and easily setup and adjust multiple projectors and perform advanced geometric correction.
- By allowing daisy-chain connections, you can project simultaneously without having to use a distributor.
- Using the blending function with 4K enhanced image quality, you can realize a large screen with high image quality.

## Install in a Variety of Environments

- A lightweight and compact housing provides a space-saving installation.
- A zoom of x1.4 or greater combined with lens shifting capability allows you to avoid uneven ceilings and lighting when installing. The zoom value varies depending on your projector model.
- With a throw ratio of 0.5 or greater, you can install the projector with a short distance. The throw ratio varies depending on your projector model.

## Easy Wireless Projection

- Connect your projector and mobile device wirelessly using Miracast technology to project images.





- Epson iProjection (Windows/Mac) to project up to four images at the same time by splitting the projected screen. You can project images from computers on the network, or from smartphones or tablet devices on which Epson iProjection is installed.

See the *Epson iProjection Operation Guide (Windows/Mac)* for details.

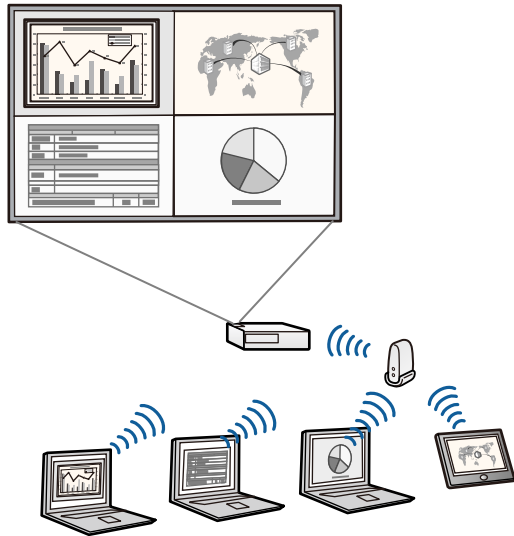

- When projecting images using a wireless LAN, set up your projector and computer for wireless projection.  
Depending on your projector model, you may need to purchase the optional wireless LAN module. See the *Quick Reference* for a list of items supplied with your projector.
- Some models have built-in wireless LAN modules.
- You can download the necessary software and manuals from the following Web site:  
[epson.sn](http://epson.sn)

- Epson iProjection (iOS/Android) to connect your projector and mobile device wirelessly using the app available on the App Store or Google Play.



Any fees incurred when communicating with the App Store or Google Play are the responsibility of the customer.

- Epson iProjection (Chromebook) to connect your projector and Chromebook device wirelessly using the app available on the Chrome Web Store.



Any fees incurred when communicating with the Chrome Web Store are the responsibility of the customer.

### ▶▶ Related Links

- "Wired Network Projection" [p.139](#)
- "Wireless Network Projection" [p.143](#)
- "Wireless Network Projection from a Mobile Device (Miracast)" [p.153](#)
- "List of Functions" [p.11](#)

## Linking with Apple Devices

- With AirPlay, you can stream media such as videos, music, and photos to this projector using Apple devices that support AirPlay.

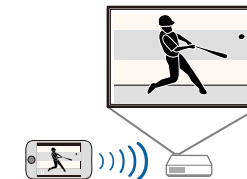

Works with  
**Apple AirPlay**



Works with  
**Apple Home**

Use of the Works with Apple AirPlay badge means that an accessory has been designed to work specifically with the technology identified in the badge and has been certified by the developer to meet Apple performance standards.

Use of the Works with Apple badge means that an accessory has been designed to work specifically with the technology identified in the badge and has been certified by the developer to meet Apple performance standards. Apple is not responsible for the operation of this device or its compliance with safety and regulatory standards.

Controlling this HomeKit-enabled accessory automatically and away from home requires a HomePod, HomePod mini, or Apple TV set up as a home hub. It is recommended that you update to the latest software and operating system.

---

## Environmentally-Friendly

- We have used pulp-molded products for cushioning materials (or cushioning packaging materials) and recycled plastics for part of the projector body.
- We aim to reduce the environmental impact through power consumption reduction functions.
- Equipped with an air filter that does not require replacement for an extended period.

The following sections explain the projector parts and their functions.

All of the features in this guide are explained using illustrations of EB-L890E unless otherwise mentioned.

The shape of the projector part may vary depending on the model of your projector.



Remove the protective film from the projector before using for the first time.

### ► Related Links

- "Projector Parts - Front/Top" [p.19](#)
- "Projector Parts - Rear" [p.20](#)
- "Projector Parts - Base" [p.21](#)
- "Projector Parts - Interface Ports" [p.22](#)
- "Projector Parts - Control Panel" [p.23](#)
- "Projector Parts - Remote Control" [p.24](#)

## Projector Parts - Front/Top

EB-L890E/EB-L895E/EB-L690E/EB-L890U/EB-L895U/EB-L790U/EB-L690U

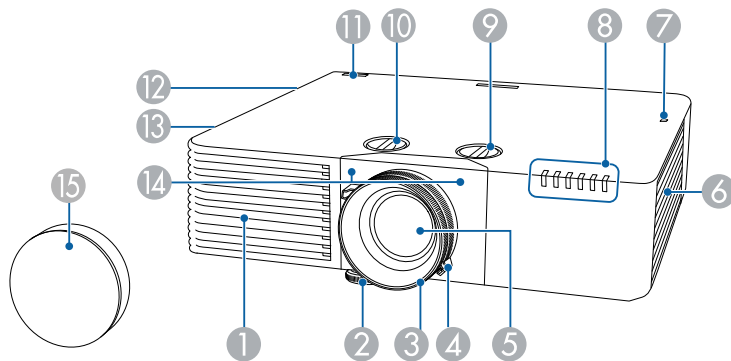

EB-L790SE/EB-L795SE/EB-L790SU/EB-L690SU/EB-L695SU

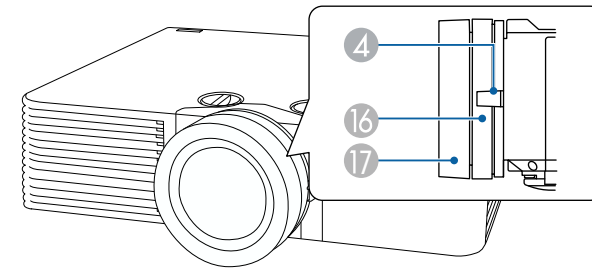

EB-L690SE/EB-L695SE

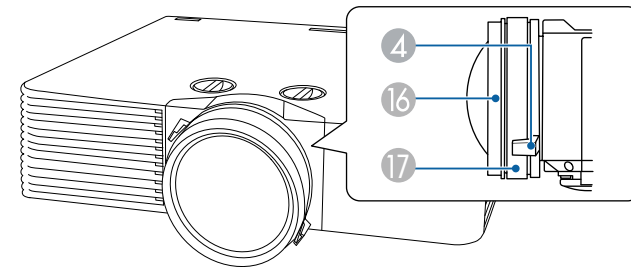

Name		Function
①	Air intake vent	Takes in air to cool the projector internally.
②	Front adjustable foot	When setup on a surface such as a desk, extend the foot to adjust the position of the image.
③	Focus ring	Adjusts the image focus.
④	Zoom ring	Adjusts the image size.
⑤	Lens	Images are projected from here.
⑥	Air intake vent (air filter)	Takes in air to cool the projector internally.

Name	Function
7 NFC tag	<p>Uses NFC technology to transfer projector information through your mobile device.</p> <p>The Projector Config Tool app lets you scan projector information and write settings.</p> <p>You can download the Projector Config Tool app for free from the App Store or Google Play. Any fees incurred when communicating with the App Store or Google Play are the responsibility of the customer.</p>
8 Indicators	Indicates the projector's status.
9 Vertical lens shift dial	Turn the dial to move the position of the projected image up or down.
10 Horizontal lens shift dial	Turn the dial to move the position of the projected image left or right.
11 Remote receiver	Receives signals from the remote control.
12 Speaker	Outputs audio.
13 Air exhaust vent	<p>Exhaust vent for air used to cool the projector internally.</p> <div style="border: 1px solid black; padding: 5px; margin-top: 10px;"> <p><b>⚠ Caution</b></p> <p>While projecting, do not put your face or hands near the air exhaust vent, and do not place objects that may become warped or damaged by heat near the vent. Hot air from the air exhaust vent could cause burns, warping, or accidents to occur.</p> </div>
14 Remote receiver	Receives signals from the remote control.
15 Lens cover	Attach when not using the projector to protect the lens.
16 Focus ring (center)	Adjusts the focus of the center of the image.
17 Focus ring (corner)	Adjusts the focus of the corner of the image.

### ►► Related Links

- "Resizing the Image with the Zoom Ring" [p.75](#)
- "Focusing the Image Using the Focus Ring" [p.76](#)
- "Focusing the Image Using the Focus Ring (Center/Corner)" [p.77](#)
- "Attaching and Removing the Cable Cover" [p.43](#)
- "Adjusting the Image Position Using Lens Shift" [p.59](#)
- "Projector Indicator Status" [p.244](#)
- "Remote Control Operation" [p.45](#)
- "Air Filter and Vent Maintenance" [p.234](#)

## Projector Parts - Rear

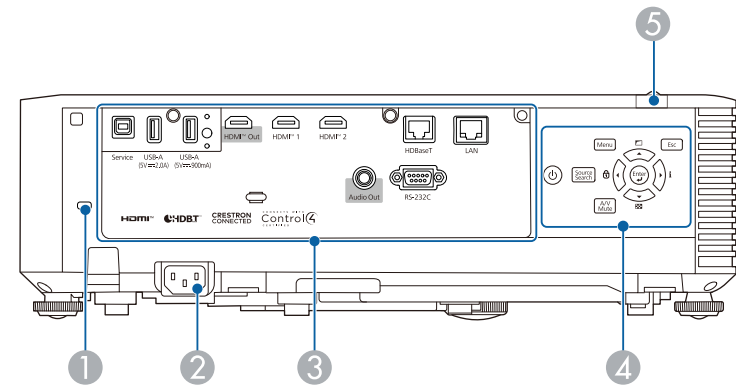

Name	Function
1 Security slot	The security slot is compatible with the Microsaver Security System manufactured by Kensington.
2 Power inlet	Connects the power cord to the projector.
3 Interface ports	Connects cables for external devices.
4 Control panel	Operates the projector.
5 Remote receiver	Receives signals from the remote control.

► **Related Links**

- "Projector Parts - Interface Ports" [p.22](#)
- "Installing a Security Cable" [p.137](#)

## Projector Parts - Base

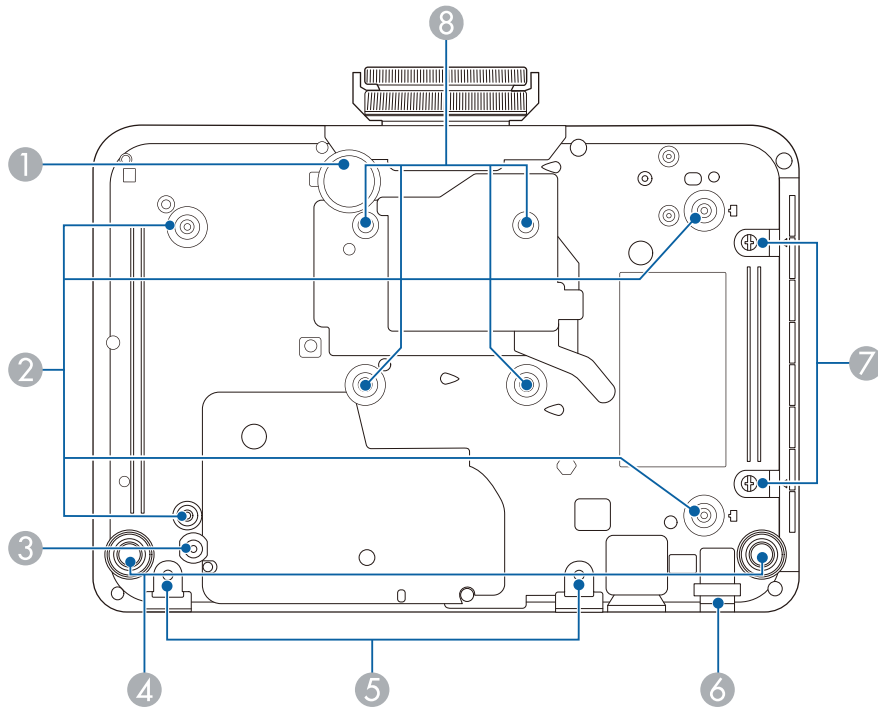

Name	Function
③ Wire clamp fixing point	When you use the optional ceiling mount, fix the carabiner here to attach the safety wire and prevent the projector from falling from the ceiling or wall.
④ Rear feet	When setup on a surface such as a desk, turn to extend and retract to adjust the horizontal tilt.
⑤ Screw holes for optional cable cover	Screw holes to fix the optional cable cover in place.
⑥ Security cable attachment point	Pass a commercially available wire lock through here and lock it in place.  <div style="border: 1px solid black; background-color: #ffffcc; padding: 5px; text-align: center;"> <p><b>⚠ Warning</b> Do not attach the safety wire to this point.</p> </div>
⑦ Air filter cover screws	Screws to fix the air filter cover in place.
⑧ Fixing points (four points)	Use all the fixing points to attach a commercially available mount compatible with the VESA Mounting Interface Standard (100 × 100 mm) when installing the projector on a wall or suspending the projector from a ceiling.

► **Related Links**

- "Installing a Security Cable" [p.137](#)

Name	Function
① Front adjustable foot	When setup on a surface such as a desk, extend the foot to adjust the position of the image.
② Ceiling mount fixing points (four points)	Use all the fixing points to attach the optional ceiling mount here when suspending the projector from a ceiling.

## Projector Parts - Interface Ports

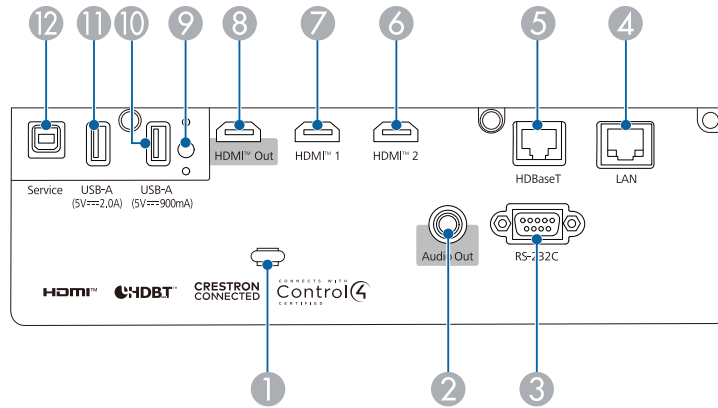

Name	Function
1 Cable holder	Pass a commercially available cable tie through here to secure cables.
2 Audio Out port	Outputs audio from the current input source to an external speaker.
3 RS-232C port	Connects an RS-232C cable to control the projector from a computer. (You do not need to use this port normally.)
4 LAN port	Connects a LAN cable to connect to a network.
5 HDBaseT port	Connects a LAN cable to the optional HDBaseT Transmitter. This port is compatible with HDCP2.3.
6 HDMI2 port	Inputs video signals from HDMI compatible video equipment and computers. This port is compatible with HDCP2.3.
7 HDMI1 port	

Name	Function
8 HDMI Out port	Connecting an HDMI cables from this port to the HDMI port of another projectors lets you create and project a single unified image. This port is compatible with HDCP2.3.
9 Wireless LAN module fixing screw	Secures the wireless LAN module cover. (EB-L690SE/EB-L695SE)
10 USB-A (5V/900mA) port	Connects a USB device and projects movies or images. Use to connect the optional document camera. Use to connect the wireless LAN module. Use to connect the external camera. Use to connect a USB memory device to save error and operation log files. It is also used for batch settings and firmware update. The method for updating the firmware differs depending on your projector model. For details, see the "List of Functions" in this manual.

 In this guide, USB-A (5V/900mA) and USB-A (5V/2.0A) ports are collectively referred to as the USB-A port.

Name	Function
⑪ USB-A (5V===2.0A) port	<p>Connects a USB device and projects movies or images.</p> <p>Use to connect the optional document camera.</p> <p>Use to connect the external camera.</p> <p>Use to connect a USB memory device to save error and operation log files.</p> <p>It is also used for batch settings and firmware update.</p> <p>The method for updating the firmware differs depending on your projector model. For details, see the "List of Functions" in this manual.</p> <div style="border: 1px solid black; padding: 5px; margin-top: 10px;">  <p>In this guide, USB-A (5V===900mA) and USB-A (5V===2.0A) ports are collectively referred to as the USB-A port.</p> </div>
⑫ Service port	<p>This port is used for batch settings and firmware update.</p> <p>The method for updating the firmware differs depending on your projector model. For details, see the "List of Functions" in this manual.</p>

► **Related Links**

- "List of Functions" [p.11](#)
- "Copying Menu Settings Between Projectors (Batch Setup)" [p.227](#)
- "Updating the Firmware" [p.238](#)
- "External Camera Usage" [p.131](#)
- "Connecting Multiple Projectors of the Same Model" [p.41](#)
- "Projector Connections" [p.35](#)
- "Wireless Network Projection" [p.143](#)

## Projector Parts - Control Panel

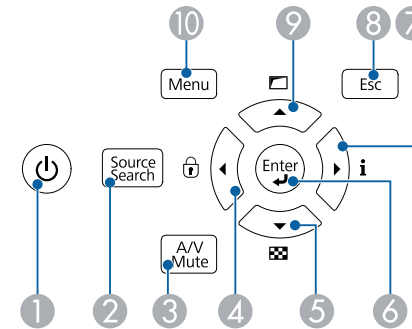

Name	Function
① Power button (⏻)	Turns the projector on or off.
② [Source Search] button	Changes to the next input source.
③ [A/V Mute] button	Turns the video and audio on or off temporarily.
④ Left arrow button	Displays the Control Panel Lock screen. Selects menu items while displaying the projector's menu.
⑤ Down arrow button	Displays a test pattern. Selects menu items while displaying the projector's menu.
⑥ [Enter] button (↵)	Enters the current selection and moves to the next level while displaying the projector's menu.
⑦ Right arrow button	Displays the Info screen. Selects menu items while displaying the projector's menu.
⑧ [Esc] button	Stops the current function. Moves back to the previous menu level while displaying the projector's menu.

Name	Function
9 Up arrow button	Displays the Geometry Correction screen. Selects menu items while displaying the projector's menu.
10 [Menu] button	Displays and closes the projector's menu.



►► **Related Links**

- "Selecting an Image Source" p.78
- "Adjusting the Menu Settings" p.190

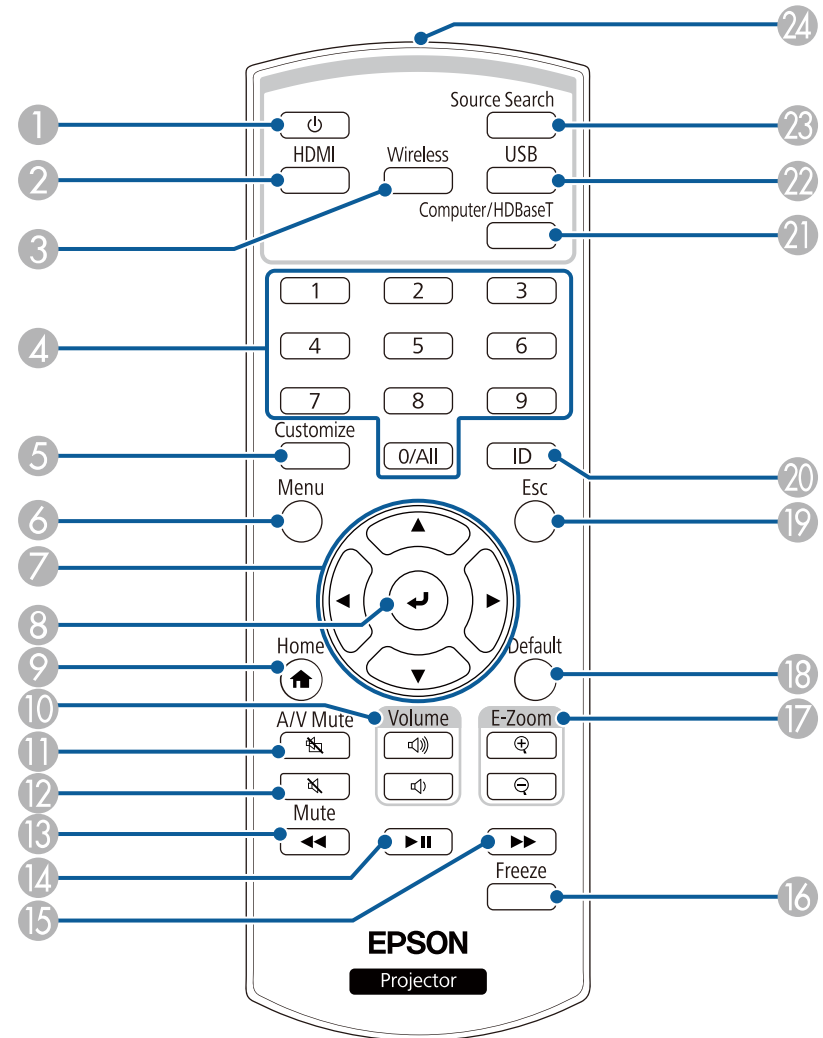
## Projector Parts - Remote Control





Name	Function
① Power button (  )	Turns the projector on or off.
② [HDMI] button	Switches the image source between the HDMI1 and HDMI2 ports.
③ [Wireless] button	Switches the image source to the network connected device.
④ Numeric buttons	Enters numbers in the projector's menu.
⑤ [Customize] button	Performs settings assigned in the <b>Customize Button</b> setting in the projector's <b>Management</b> menu.
⑥ [Menu] button	Displays and closes the projector's menu.
⑦ Arrow buttons	Selects menu items while displaying the projector's menu.
⑧ [Enter] button (  )	Enters the current selection and moves to the next level while displaying the projector's menu.
⑨ [Home] button	Displays and closes the Home screen.
⑩ [Volume] up/down buttons	Adjusts the speaker volume.
⑪ [A/V Mute] button	Turns the video and audio on or off temporarily.
⑫ [Mute] button	Turns the audio on or off temporarily.
⑬ Rewind button	Rewinds the images. (For streaming with AirPlay/For HDMI CEC)
⑭ Pause/Play button	Pauses or plays the images. (For streaming with AirPlay/For HDMI CEC)
⑮ Fast-Forward button	Fast-forwards the images. (For streaming with AirPlay/For HDMI CEC)
⑯ [Freeze] button	Pauses or resumes images.
⑰ [E-Zoom] +/- buttons	Resizes the projected image.
⑱ [Default] button	Returns the selected setting to its default value.

Name	Function
⑲ [Esc] button	Stops the current function. Moves back to the previous menu level while displaying the projector's menu.
⑳ [ID] button	Hold down this button and press the numeric buttons to select the ID for the projector you want to operate using the remote control.
㉑ [Computer/HDBaseT] button	Switches the image source from the HDBaseT input port.
㉒ [USB] button	Selects the USB-A port as the image source.
㉓ [Source Search] button	Switches to the next input source.
㉔ Remote control light emitting area	Outputs remote control signals.

### ▶▶ Related Links

- "Selecting an Image Source" [p.78](#)
- "Projecting in Content Playback Mode" [p.104](#)
- "Adjusting the Menu Settings" [p.190](#)
- "Adjusting Image Quality (Color Mode)" [p.82](#)
- "Image Aspect Ratio" [p.80](#)
- "Zooming Images (E-Zoom)" [p.113](#)
- "Shutting Off the Image and Sound Temporarily" [p.110](#)
- "Projecting Two Images Simultaneously" [p.96](#)
- "Home Screen" [p.48](#)
- "Stopping Video Action Temporarily" [p.111](#)
- "Controlling the Volume with the Volume Buttons" [p.92](#)

# Setting Up the Projector

Follow the instructions in these sections to set up your projector.

## ► Related Links

- "Projector Placement" [p.27](#)
- "Installing the Safety Wire" [p.32](#)
- "Projector Connections" [p.35](#)
- "Connecting Multiple Projectors of the Same Model" [p.41](#)
- "Attaching and Removing the Cable Cover" [p.43](#)
- "Installing Batteries in the Remote Control" [p.44](#)

You can place the projector on almost any flat surface to project an image. You can also install the projector in a ceiling mount if you want to use it in a fixed location. An optional ceiling mount is required when suspending the projector from a ceiling.

You can also use a commercially available mount compatible with the VESA Mounting Interface Standard (100 × 100 mm).

The projector can be installed at various angles. There is no vertical or horizontal limit to how the projector can be installed.

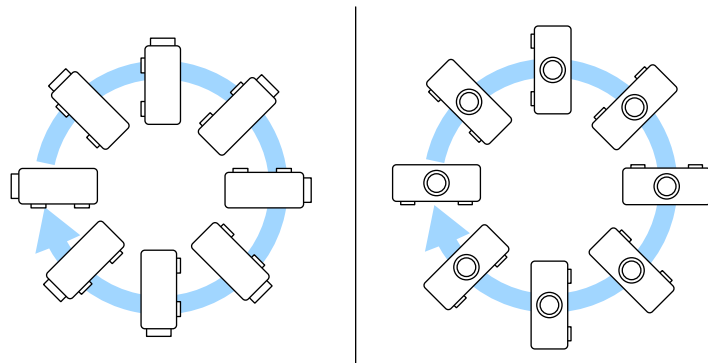

- Leave plenty of space around and under the projector for ventilation, and do not place it on top of or next to anything that could block the vents.
- Place the projector so it squarely faces the screen, not at an angle.

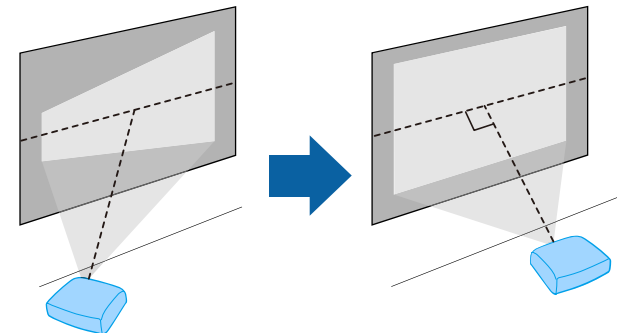

Note the following points when selecting a projector location:

- Place the projector on a sturdy, level surface or install it using a compatible mount.

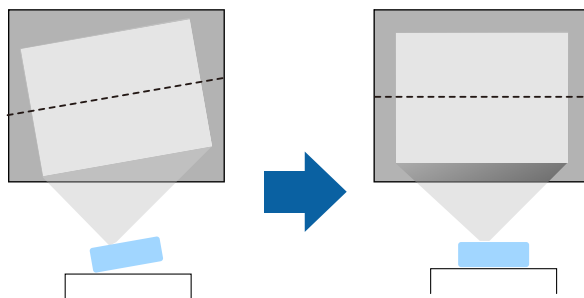

## Warning

- You must install a ceiling mount when suspending the projector from a ceiling. If you do not install the projector correctly, it could fall and cause damage or injury.
- Do not use adhesives on the ceiling mount fixing points to prevent the screws from loosening, or use lubricants, oils, or similar substances on the projector; the projector case may crack causing it to fall from its ceiling mount. This could cause serious injury to anyone under the ceiling mount and could damage the projector.
- Improper installation of the ceiling mount and projector could cause the projector to fall. Secure the ceiling mount using all of the ceiling mount fixing points specified in the projector's User's Guide. Also, use a wire or other item that is strong enough to secure the projector and the mount. Use only mounts specified by Epson that are compatible with this projector.
- Do not install the projector in a location subject to high levels of dust or humidity, or in a location subject to smoke or steam. Otherwise, it could cause a fire or electric shock to occur. The projector's case could also deteriorate and be damaged causing the projector to fall from the mount.

### Examples of environments that could cause the projector to fall due to case deterioration

- Locations subject to excessive smoke or airborne oil particles, such as factories or kitchens
- Locations containing volatile solvents or chemicals, such as factories or laboratories
- Locations where the projector could be subjected to detergents or chemicals, such as factories or kitchens
- Locations in which aroma oils are often used, such as relaxation rooms
- Near devices that produce excessive smoke, airborne oil particles, or foam at events
- Locations near humidifiers

## Warning

- Do not cover the projector's air intake or air exhaust vents. If the vents are covered, the internal temperature could rise and cause a fire.
- Do not use or store the projector in locations where it will be subject to dust or dirt. Otherwise, the quality of the projected image may decline. If the lens or air filter gets dusty, it may result in a malfunction or fire.
- Do not install the projector on an unstable surface or in a location beyond the weight specifications of the projector. Otherwise, it could fall or topple causing an accident and injury.
- When installing the projector in a high position, take measures to prevent falling by using wires to ensure safety in an emergency, such as an earthquake, and to prevent accidents. If it is not installed correctly, it could fall causing an accident and injury.
- Do not install in locations where salt damage could occur, or in locations subject to corrosive gas such as sulphuric gas from hot springs. Otherwise, corrosion could cause the projector to fall. It could also cause the projector to malfunction.

## Attention

- If you are using the projector at altitudes above 1,500 m, set the **High Altitude Mode** setting to **On** in the projector's **Installation** menu to ensure the projector's internal temperature is regulated properly.
- Try not to setup the projector in locations subject to high humidity and dust, or in locations subject to smoke from fires or tobacco smoke.

## ▶▶ Related Links

- "Notes on Transporting" [p.29](#)
- "Projector Setup and Installation Options" [p.29](#)
- "Projection Distance" [p.31](#)
- "Image Shape" [p.62](#)

## Notes on Transporting

There are many glass parts and precision components inside the projector. To prevent damage due to impacts when transporting, handle the projector as follows.

- Remove any equipment connected to the projector.
- Position the lens near the center of the lens shift adjustment range by turning the vertical and horizontal lens shift dials.
- Attach the lens cover that was included with the projector.
- When transporting the projector a long distance or as checked luggage, pack it in a firm box with cushioning around it and mark the box "Fragile."
- When shipping the projector for repairs, place it in its original packing materials, if possible, or use equivalent materials with cushioning around the projector. Mark the box "Fragile."



Epson shall not be liable for any damages incurred during transportation.

## Projector Setup and Installation Options

You can set up or install your projector in the following ways:

Front/Rear

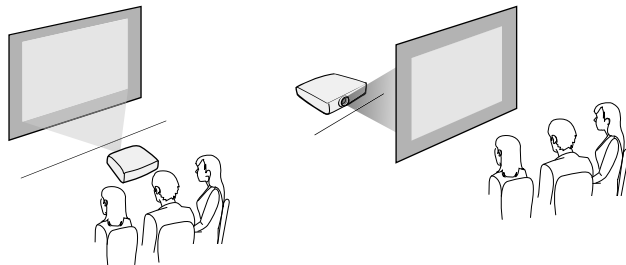

Front Ceiling/Rear Ceiling

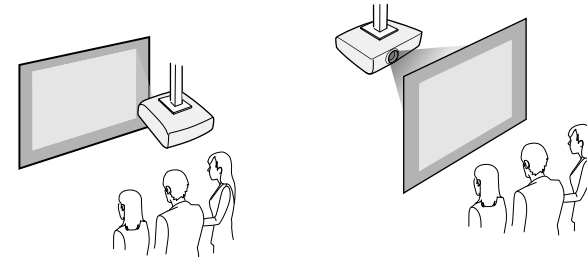

Select the correct **Projection** option in the projector's **Installation** menu according to the installation method being used. If necessary, turn on the **Inv Direction Button** setting in the projector's **Installation** menu and adjust the **Menu Rotation** setting in the projector's **Display** menu.

### ▶▶ Related Links

- "Precautions on Installation" [p.29](#)
- "Projection Modes" [p.54](#)

## Precautions on Installation

Note the following precautions when installing the projector.

## Attention

- If the projector is installed at an angle, it should be installed by qualified technicians using mounting hardware designed for use with this projector.
- Install the projector appropriately to prevent it from falling down.
- Use M4 screws (up to a depth of 9 mm) to fix the projector's ceiling mount fixing points and the mounting hardware at four points.

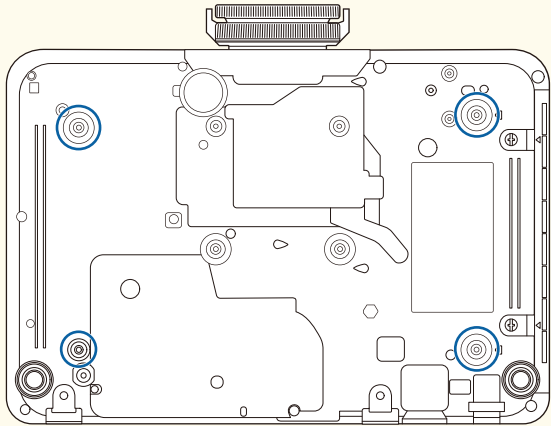

## Installation space

### Attention

Be sure to leave the following amount of space around the projector so as not to block the air exhaust and intake vents.

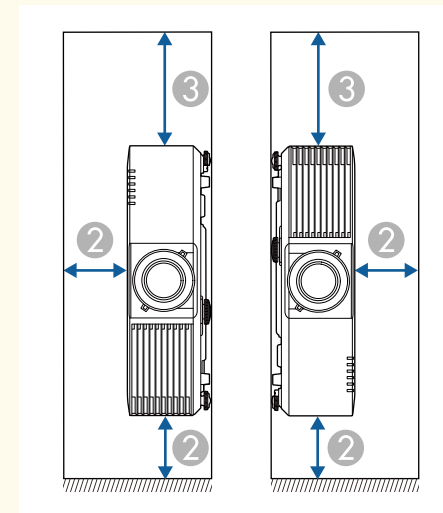
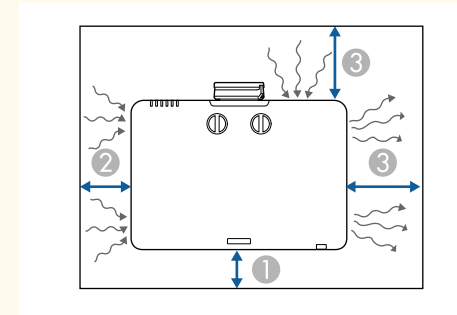

① 10 cm

② 20 cm

③ 40 cm

## Installation space (When installing multiple projectors side by side)

### Attention

- If you are installing multiple projectors next to each other, make sure hot air from the exhaust vent does not go into the air intake vent of another projector.

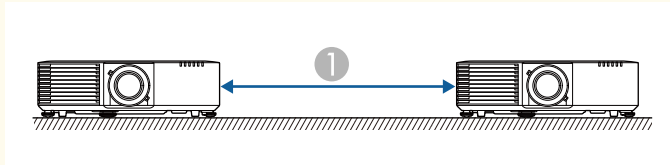

① 150 cm

- If you use a partition, you can narrow the space between the projectors.

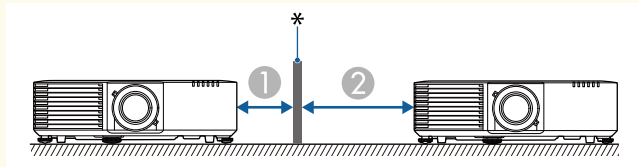

① 20 cm

② 40 cm

\* Partition

is from the screen, but can vary depending on the zoom factor, aspect ratio, and other settings.

See the Appendix for details about how far to place the projector from the screen based on the size of the projected image.

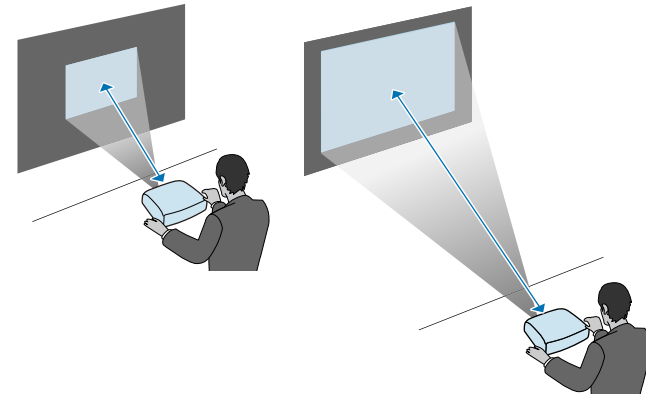

### ► Related Links

- "Screen Size and Projection Distance" [p.266](#)

## Projection Distance

The distance at which you place the projector from the screen determines the approximate size of the image. The image size increases the farther the projector

You can install the safety wire to prevent the projector from falling from the ceiling.

## Warning

Be sure to use the safety wire provided with the Epson ceiling mount. The safety wire is available as an optional Safety Wire Set ELPWR01.

## Attention

When placing the projector upside down, make sure to place a cloth or other cushioning material underneath the projector to protect the lens. (EB-L790SE/EB-L795SE/EB-L690SE/EB-L695SE/EB-L790SU/EB-L690SU/EB-L695SU)

## ▶ Related Links

- "When Using the Ceiling Mount ELPMB22" [p.32](#)
- "When Using the Ceiling Mount ELPMB30" [p.33](#)

## When Using the Ceiling Mount ELPMB22

You can attach a safety wire to your projector for increased safety as shown.

Before you start, make sure you have firmly installed the ELPMB22 ceiling mount on the projector and have the following items that are included in the safety wire set:

- Safety wire × 1
- Carabiner × 2
- Wire clamp × 1
- Attaching screw (M4 × 10 mm) × 1



For details on installing the ELPMB22, see the *Ceiling Mount ELPMB22/ELPMB23 Instruction Manual*.

- 1** Attach a carabiner to the hole on the ceiling mount, and tighten the carabiner lock.

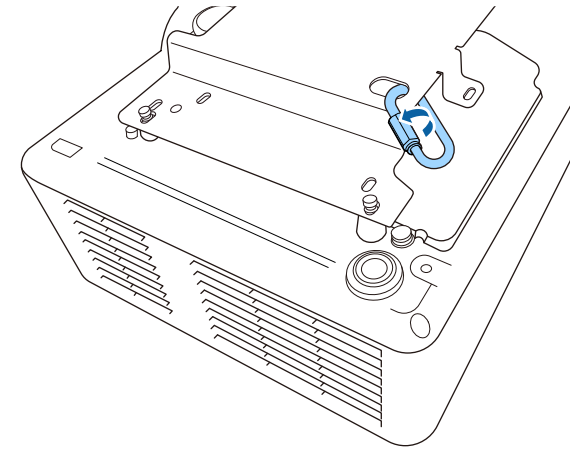

- 2** Attach the wire clamp to another carabiner, and then use the screw to fix the wire clamp to the wire clamp fixing point on the projector.

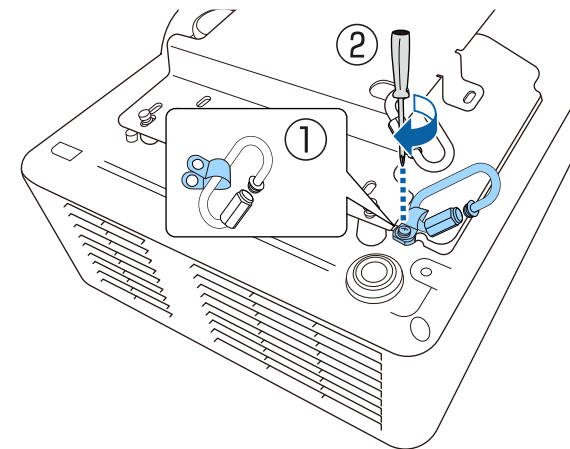



- 3** Loop the safety wire through the carabiner on the ceiling mount, and attach both ends to the carabiner on the projector.

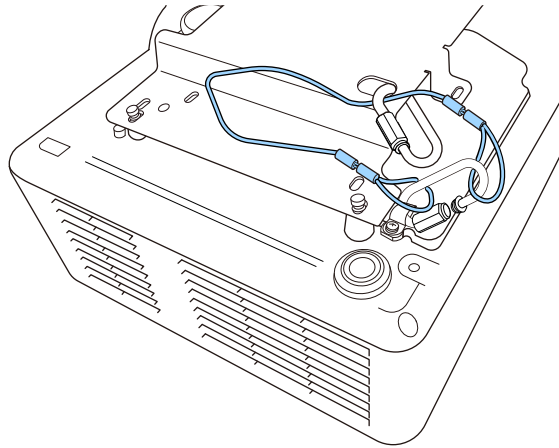

**Warning**

Do not attach the safety wire to the security cable attachment point.

- 4** Tighten the carabiner lock.

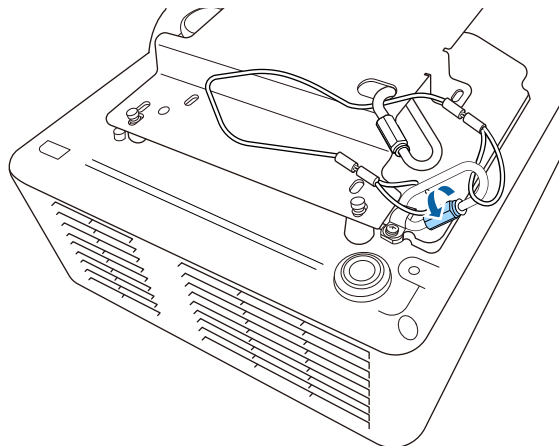

## When Using the Ceiling Mount ELPMB30

You can attach a safety wire to your projector for increased safety as shown. Before you start, make sure you have firmly installed the ELPMB30 ceiling mount on the projector and have the following items that are included in the safety wire set:

- Safety wire × 1
- Carabiner × 2 (Only one carabiner is used for the ELPMB30.)
- Wire clamp × 1
- Attaching screw (M4 × 10 mm) × 1



For details on installing the ELPMB30, see the *ELPMB30 User's Guide*.

- 1** Attach the wire clamp to the carabiner, and then use the screw to fix the wire clamp to the screw into the wire clamp fixing point on the projector.

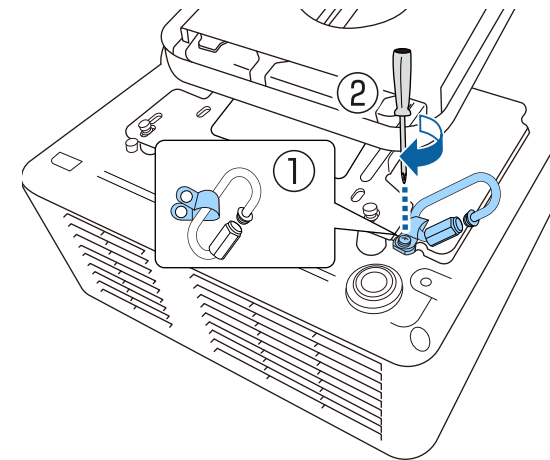

- 2** Loop the safety wire through the hole in the ceiling mount, and then attach both ends to the carabiner.

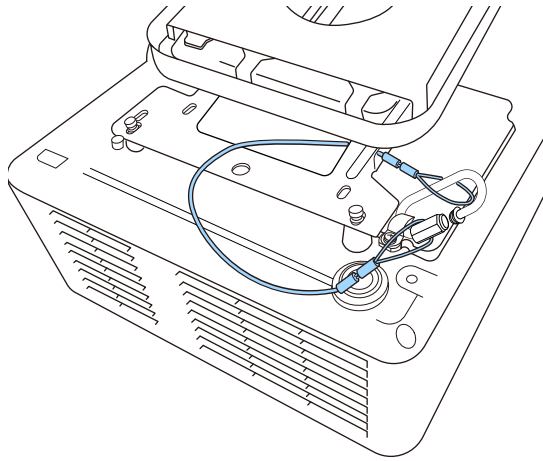

- 3** Tighten the carabiner lock.

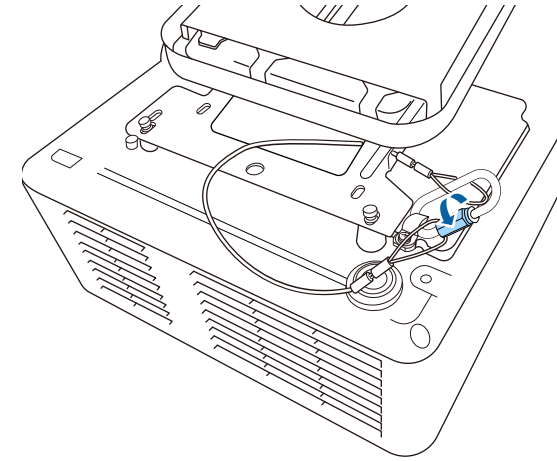

**⚠ Warning**

Do not attach the safety wire to the security cable attachment point.

See these sections to connect the projector to a variety of projection sources.

## Attention

- Check the shape and orientation of the connectors on any cable you plan to connect. Do not force a connector into a port if it does not fit. The device or your projector could be damaged or could malfunction.



See the *Quick Reference* for a list of cables supplied with your projector. Purchase optional or commercially available cables when necessary.

## ► Related Links

- "Connecting to a Computer" [p.35](#)
- "Connecting to Video Sources" [p.35](#)
- "Connecting to External USB Devices" [p.36](#)
- "Connecting to a Document Camera" [p.37](#)
- "Connecting to an HDBaseT Transmitter" [p.37](#)
- "Connecting to the Base Unit" [p.38](#)
- "Connecting to External Devices" [p.39](#)

## Connecting to a Computer

Follow the instructions in these sections to connect a computer to the projector.

### ► Related Links

- "Connecting to a Computer for HDMI Video and Audio" [p.35](#)

### Connecting to a Computer for HDMI Video and Audio

If your computer has an HDMI port, you can connect it to the projector using an HDMI cable and send the computer's audio with the projected image.

**1** Connect the HDMI cable to your computer's HDMI output port.

**2** Connect the other end to the projector's HDMI port.

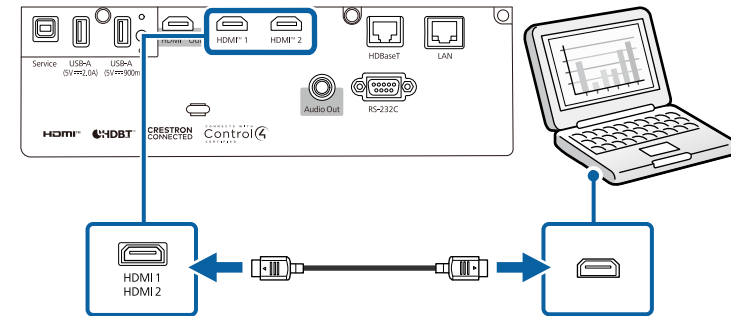

## Connecting to Video Sources

Follow the instructions in these sections to connect video devices to the projector.



- When sending 18 Gbps images such as 4K 60Hz 4:4:4, use an HDMI cable (premium-high speed). If you use an incompatible cable, images may not be displayed correctly.
- If the port on the device you connect has an unusual shape, use the cable supplied with the device or an optional cable to connect to the projector.
- The cable differs depending on the output signal from the connected video devices.
- Some video devices are capable of outputting different types of signals. See your video device manual to confirm what type of signals can be output.
- If audio is not output correctly, check the settings in **Audio Out Device**.
  - ☛ **Signal I/O > HDMI Link > Audio Out Device**

## ► Related Links

- "Connecting to an HDMI Video Source" [p.36](#)

## Connecting to an HDMI Video Source

If your video source has an HDMI port, you can connect it to the projector using an HDMI cable and send the image source's audio with the projected image.

### Attention

Do not turn on the video source before connecting it to the projector. Doing so could damage the projector.

- 1** Connect the HDMI cable to your video source's HDMI output port.
- 2** Connect the other end to the projector's HDMI port.

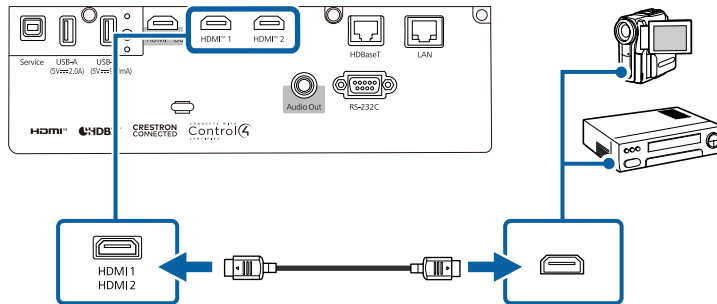

## Connecting to External USB Devices

Follow the instructions in these sections to connect external USB devices to the projector.

## ► Related Links

- "USB Device Projection" [p.36](#)
- "Connecting to a USB Device" [p.37](#)
- "Disconnecting a USB Device" [p.37](#)

## USB Device Projection

You can project images and other content without using a computer or video device by connecting any of these devices to your projector:

- USB flash drive
- Digital camera or smartphone
- USB hard drive



- Digital cameras or smartphones must be USB-mounted devices, not TWAIN-compliant devices, and must be USB Mass Storage Class-compliant.
- USB hard drives must meet these requirements:
  - USB Mass Storage Class-compliant (not all USB Mass Storage Class devices are supported)
  - Formatted in FAT16/32
  - Self-powered by their own AC power supplies (bus-powered hard drives are not recommended)
  - MBR partition table format
  - Avoid using hard drives with multiple partitions

You can also project playlists that contain images and movies saved on a USB flash drive in Content Playback mode.

## ► Related Links

- "Projecting a PC Free Presentation" [p.99](#)
- "Projecting in Content Playback Mode" [p.104](#)

## Connecting to a USB Device

You can connect your USB device to the projector's USB-A port and use it to project images and other content.

- 1 If your USB device came with a power adapter, plug the device into an electrical outlet.
- 2 Connect the USB cable or USB flash drive to the projector's USB-A port as shown.

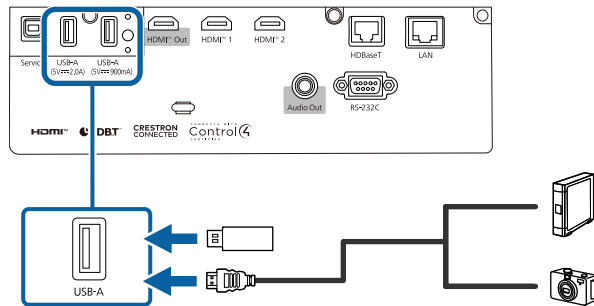

### Attention

- Use the USB cable supplied with or specified for use with the device.
- Do not connect a USB hub or a USB cable longer than 3 meters, or the device may not operate correctly.

- 3 Connect the other end to your device, if necessary.

## Disconnecting a USB Device

When you have finished projecting with a connected USB device, disconnect the device from the projector.

- 1 Turn off and unplug the device, if necessary.
- 2 Disconnect the USB device from the projector.

## Connecting to a Document Camera

You can connect a document camera to your projector to project images viewed by the camera.

The connection method varies depending on your Epson document camera model. See the document camera manual for details.

## Connecting to an HDBaseT Transmitter

To send an HDMI or RS-232C signal over a long distance, you can connect the projector to an optional HDBaseT transmitter using a 100Base-TX network cable. This is useful when you want to send a signal to or control the projector from a remote location, such as in a hall or event site, since you can use a network cable up to 100 m in length. To ensure proper data transmission, use a Category 5e STP cable or better. However, operation is not guaranteed for all input/output devices and environments.



- To enable communication from the Ethernet and serial ports on the transmitter, select **On** as the **Control Communications** setting in the projector's **Operation** menu. Turning on this setting disables the projector's LAN and RS-232C ports.
  - ☛ **Operation > HDBaseT > Control Communications**
- If you connected an Extron XTP transmitter or switcher to the projector's HDBaseT port, select **On** as the **Extron XTP** setting in the projector's **Operation** menu.
  - ☛ **Operation > HDBaseT > Extron XTP**
- If you want to control the projector when the projector does not project any images, set the **Standby Mode** setting to **Normal** in the projector's **Operation** menu.



See the documentation that came with the HDBaseT transmitter for instructions on connecting it to your video device or computer.

**4** Turn on the projector and HDBaseT transmitter.

## Connecting to the Base Unit

You can use the optional wireless presentation system to project through the base unit (receiver). Your wireless presentation system (ELPWP20) includes one base unit (ELPBU01) and two wireless transmitters (ELPWT01). Using the projector with wireless transmitters allows you to connect to Windows/Mac computers through the base unit and project your images easily.



See the *ELPWP20 Quick Start Guide* for details on installing the base unit.

**1** Connect the HDMI cable supplied with your wireless presentation system to the HDMI Out port on the base unit.

**2** Connect the other end to the projector's HDMI port.

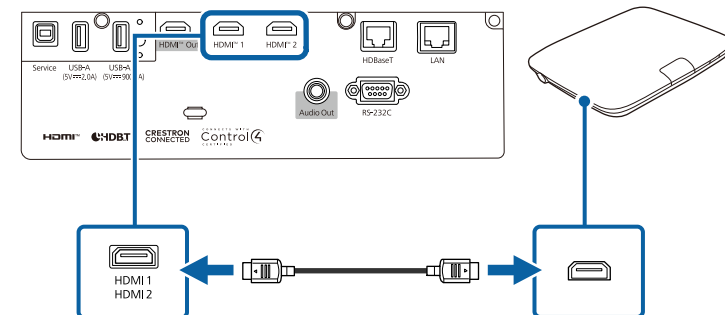

**1** Turn off the projector and HDBaseT transmitter.



Make sure the projector and HDBaseT transmitter are turned off when connecting or disconnecting a network cable between the two devices.

**2** Connect one end of the network cable to the HDBaseT port on the transmitter.

**3** Connect the other end to the projector's HDBaseT port.

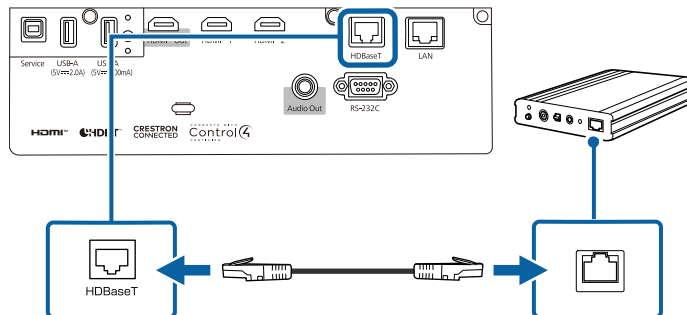

- 3 Connect the wireless transmitter to a USB port on your computer. See the *Epson Wireless Presentation System User's Guide* for details.

## Connecting to External Devices

Follow the instructions in these sections to connect external devices to the projector.

### ▶ Related Links

- "Connecting to an External HDMI Monitor" [p.39](#)
- "Connecting to External Speakers" [p.39](#)

## Connecting to an External HDMI Monitor

You can connect an external HDMI monitor to the projector's HDMI Out port and use it to display images from the current input source.



- If the audio from the projector and HDMI monitor is out of sync, mute the audio on either the projector or the HDMI monitor.
- If the output image does not appear on the HDMI monitor, change the EDID settings in the projector's **Signal I/O** menu to match the resolution of the HDMI monitor.
- Use an HDMI monitor that supports HDCP2.3.
- The HDMI Out port is not guaranteed to operate for all monitor devices and products.

- 1 Connect the HDMI cable to your monitor's HDMI input port.

- 2 Connect the other end to the projector's HDMI Out port.

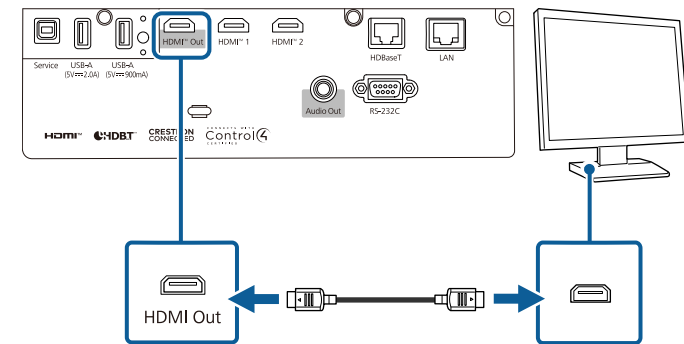

## Connecting to External Speakers

You can connect the projector to external self-powered speakers. You can control the volume using the projector's remote control.

To output audio from external speakers, set the **Audio Out Device** setting to **Projector** in the projector's **Signal I/O** menu. When an audio/video system is not connected to the projector, audio is output from the external speakers even if **Audio Out Device** is set to **AV System**.

☛ **Signal I/O > HDMI Link > Audio Out Device**



- If you want to output audio from the external speakers when the projector is turned off, set the following items in the projector's **Operation** menu:
  - Select **Normal** as the **Standby Mode** setting
  - Select **On** as the **Standby Audio Output** setting
- You can also connect the projector to an amplifier with speakers.
- The projector's built-in speaker system is disabled when you connect external speakers.

- 1** Make sure your computer or video source is connected to the projector with both audio and video cables as necessary.
- 2** Locate the appropriate cable to connect your external speakers, such as a stereo mini-jack-to-pin-jack cable, or another type of cable or adapter.
- 3** Connect one end of the cable to your external speakers as necessary.
- 4** Connect the stereo mini-jack end of the cable to your projector's Audio Out port.

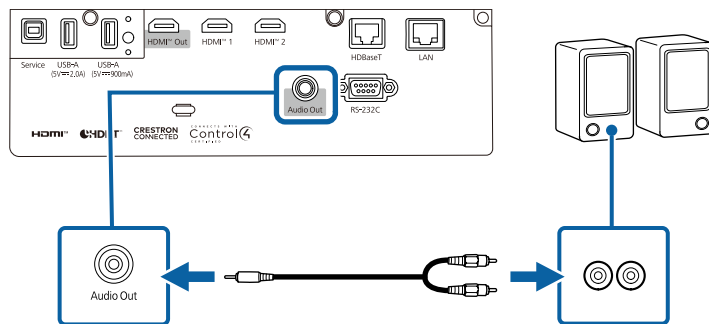



You can project the same image from multiple projectors.

You can connect multiple projectors using either of the following methods: daisy-chain connection or distributor connection. You can connect up to four projectors in a daisy-chain connection.

**Attention**

When installing the projectors, make sure hot air from the exhaust vent does not go into the air intake vent of another projector.

► **Related Links**

- "Projecting the Same Image in a Daisy-Chain Connection" p.41
- "Precautions on Installation" p.29

## Projecting the Same Image in a Daisy-Chain Connection

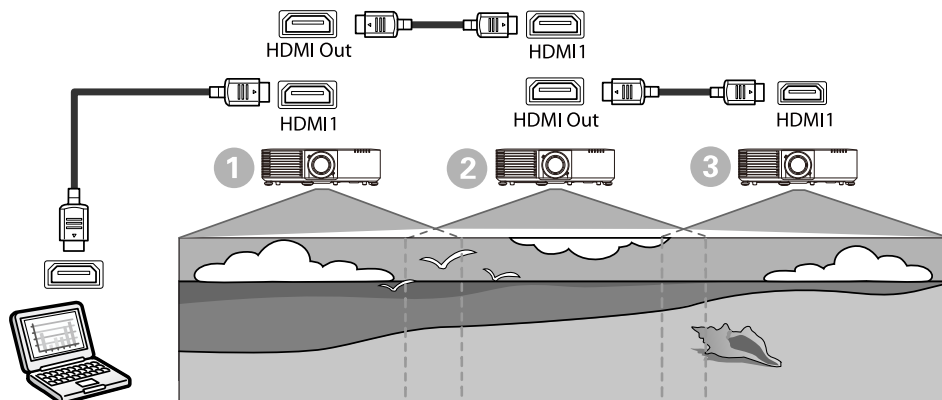

- 1** Connect the projector to the computer using the HDMI cable, and then connect the HDMI1 port and HDMI Out port of the projectors using the HDMI cable.



- The image is output from the HDMI Out port only when HDMI1 is selected as the image source.
- If you are connecting three or four projectors in a daisy-chain, connect the projectors as shown.

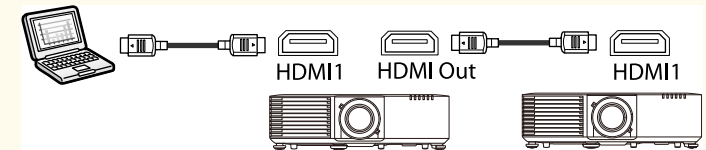

- 2** Press the [Menu] button on the control panel or remote control.
- 3** Select the **Color Mode** setting to **Multi-Projection** in the projector's **Image** menu for all of the projectors.
- 4** Select the necessary **HDMI Link** setting in the projector's **Signal I/O** menu. See the list of settings for more details.

Setting Item	①	②	③
		First projector to connect to the device	Projectors in the middle
HDMI Link Setting	HDMI Out Power Link: On HDMI Out Terminal End: Off	HDMI Out Power Link: On HDMI Out Terminal End: Off	HDMI Out Power Link: On HDMI Out Terminal End: On



This may not work if five or more projectors are connected in a daisy-chain or if the settings are not correct.

**5** Select the necessary settings in the projector's **Multi-Projection** menu.

**6** Press [Menu] or [Esc] to exit the menus.

► **Related Links**

- "Multi-Projection Features" [p.120](#)

When suspending the projector from a ceiling, you can attach the optional cable cover to hide the attached cables from view.

- 1** Pass a commercially available cable tie through the cable holder and tie the cables together.

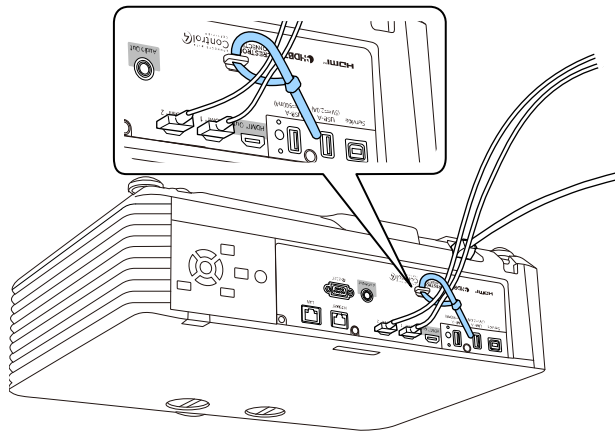

**⚠ Caution**

Do not bundle the power cord to the other cables. Otherwise, a fire may occur.

- 2** Place the cable cover on the projector as shown, guiding the cables through the notch on the base of the cable cover.

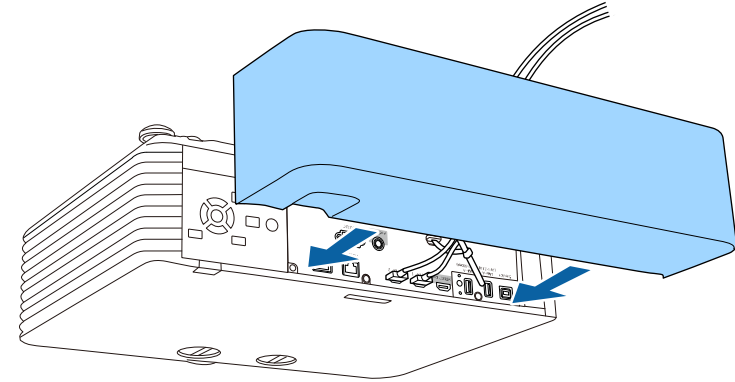

- 3** Tighten the cable cover screws.

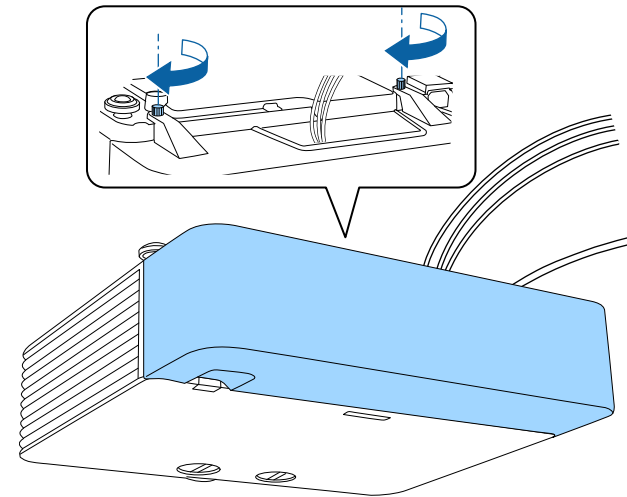

To remove the cover, loosen the cover screws and pull the cover off of the projector.

The remote control uses the two AA batteries that came with the projector.

## Attention

Make sure you read the *Safety Instructions* before handling the batteries.



Replace the batteries as soon as they run out. The remote control uses two AA manganese or alkaline batteries.

- 1 Remove the battery cover as shown.

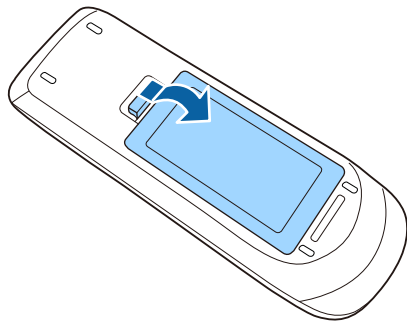

- 2 Remove the old batteries, if necessary.



Dispose of used batteries according to local regulations.

- 3 Insert the batteries with the + and - ends facing as shown.

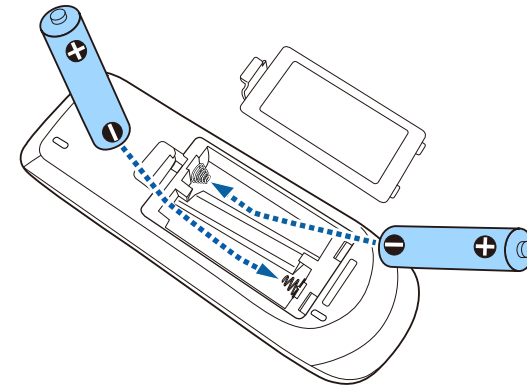

## Warning

Check the positions of the (+) and (-) marks inside the battery holder to ensure the batteries are inserted the correct way. If the batteries are not used correctly, they could explode or leak causing a fire, injury, or damage to the product.

- 4 Replace the battery cover and press it down until it clicks into place.

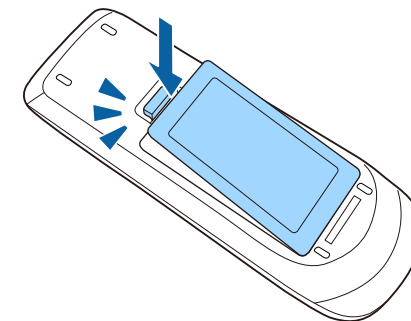

## ▶▶ Related Links

- "Remote Control Operation" [p.45](#)

## Remote Control Operation

The remote control lets you control the projector from almost anywhere in the room.

Make sure that you aim the remote control at the projector's receivers within the distance and angles listed here.

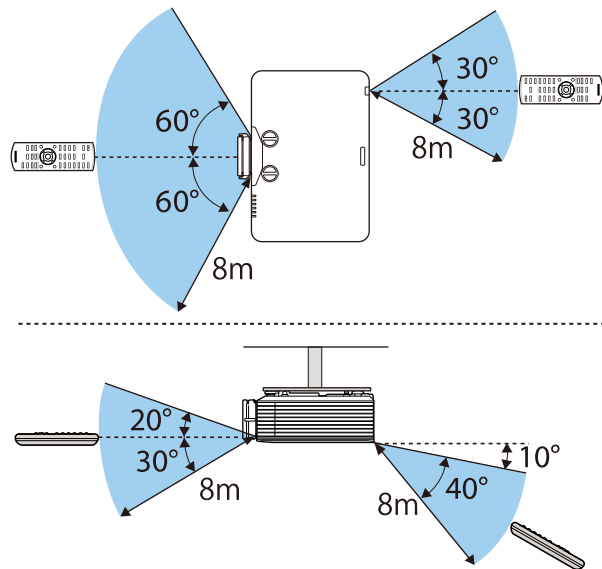

Avoid using the remote control in conditions with bright fluorescent lights or in direct sunlight, or the projector may not respond to commands. If you are not going to use the remote control for a long time, remove the batteries.

# Using Basic Projector Features

Follow the instructions in these sections to use your projector's basic features.

## ► Related Links

- "Turning On the Projector" [p.47](#)
- "Turning Off the Projector" [p.50](#)
- "Setting the Date and Time" [p.51](#)
- "Selecting the Language for the Projector Menus" [p.53](#)
- "Projection Modes" [p.54](#)
- "Setting the Screen Type" [p.56](#)
- "Adjusting the Image Position Using Lens Shift" [p.59](#)
- "Displaying a Test Pattern" [p.60](#)
- "Adjusting the Image Height" [p.61](#)
- "Image Shape" [p.62](#)
- "Resizing the Image with the Zoom Ring" [p.75](#)
- "Focusing the Image Using the Focus Ring" [p.76](#)
- "Focusing the Image Using the Focus Ring (Center/Corner)" [p.77](#)
- "Selecting an Image Source" [p.78](#)
- "Image Aspect Ratio" [p.80](#)
- "Adjusting Image Quality (Color Mode)" [p.82](#)
- "Turning On Automatic Luminance Adjustment" [p.83](#)
- "Adjusting the Image Color" [p.84](#)
- "Adjusting the Image Resolution" [p.87](#)
- "Adjusting the Brightness" [p.89](#)
- "Controlling the Volume with the Volume Buttons" [p.92](#)

Turn on the computer or video equipment you want to use after you turn on the projector.

- 1 Connect the device to the projector.

## Caution

After connecting the device to the projector, connect the power cord.

- 2 Remove the lens cover.

- 3 Connect the power cord to the projector's power inlet and plug it into an electrical outlet.

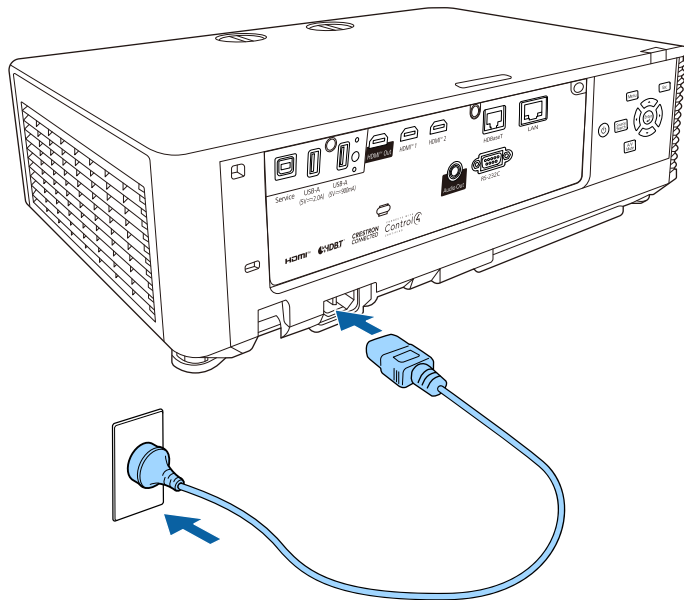

## Warning

Be sure to connect to ground before plugging in. When you remove the ground connection, unplug the power cord and disconnect from ground.

The projector's power indicator turns blue. This indicates that the projector is receiving power, but is not yet turned on (it is in standby mode).

- 4 Press the power button on the control panel or remote control to turn on the projector.

The projector beeps and the status indicator flashes blue as the projector warms up. Once the projector is warmed up, the status indicator stops flashing and turns blue.



When **Quick Startup** is enabled in the projector's **Operation** menu, the projector becomes ready for use in several seconds the next time you press the power button.

Try the following if you do not see a projected image.

- Turn on the connected computer or video device.
- Change the screen output from the computer when using a laptop computer.
- Insert a DVD or other video media, and press play (if necessary).
- Press the [Source Search] button on the control panel or remote control to detect the source.
- Press the button for the desired video source on the remote control.
- If the Home screen is displayed, select the source you want to project.

## ⚠ Warning

- Never look into the projector lens when the light source is on. This can damage your eyes and is especially dangerous for children.
- When turning on the projector at a distance using the remote control, make sure there is no one looking into the lens.
- During projection, do not block the light from the projector with a book or other objects. If the light from the projector is blocked, the area on which the light shines becomes hot which could cause it to melt, burn, or start a fire. Also, the lens may get hot due to the reflected light which could cause the projector to malfunction. To stop projection, use the A/V Mute function, or turn off the projector.



- When the **Direct Power On** setting is set to **On** in the projector's **Operation** menu, the projector turns on as soon as you plug it in. Note that the projector also turns on automatically in cases such as recovery from a power outage.
  - ☛ **Operation > Operation Settings > Direct Power On**
- If you select a specific port as the **Auto Power On** setting in the projector's **Operation** menu, the projector turns on as soon as it detects a signal or cable connection from that port.

## ▶ Related Links

- "Home Screen" [p.48](#)
- "Projector Feature Settings - Operation Menu" [p.204](#)

## Home Screen

The Home screen feature allows you to easily select an image source and access useful functions. You can display the Home screen by pressing the [Home] button on the remote control.



The Home screen is also displayed when you turn on the projector and no signal is being input.

Press the arrow buttons on the control panel or remote control to select a menu item, and then press [Enter].

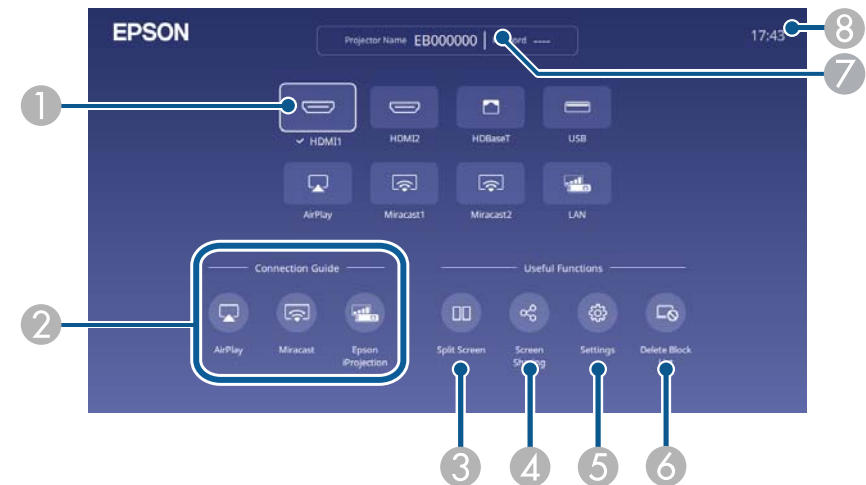

- 1 Selects the source you want to project.  
A check mark appears next to the current input source.  
You can check a preview of the current input image for most sources as a thumbnail (other than the USB input source in Content Playback mode).
- 2 Displays the connection guide. You can select the wireless connection methods according to the devices you are using, such as smartphones or computers.
- 3 Projects two images from different image sources simultaneously by splitting the projected screen.
- 4 Shares your projected screen image with other projectors connected to the same network.



5 Lets you select the following common projector settings (settings may vary depending on other selected settings):

- **Color Mode**
- **Brightness Level**
- **Volume**
- **Geometry Correction** (H/V-Keystone and Quick Corner are available.)
- **Aspect**



- The **Geometry Correction** setting is only displayed when **Geometry Correction** is set to **H/V-Keystone** or **Quick Corner** in the projector's **Installation** menu.
- The **Aspect** setting is only displayed when the current source is HDMI, HDBaseT, or USB and USB document camera. (Turn off the **Scale** setting or set the **Scale Mode** setting to **Full Display** first in the projector's **Image** menu.)

6 When **Access Control** is set to **On** in the projector's **Network Projection** menu, you can manage which devices are allowed to connect via Miracast. If a device tries to connect and you block it from the confirmation screen, it will be added to a block list. To unblock devices, you can use this icon to cancel blocked connections.

7 Displays the projector name and the projector keyword.

8 Displays the current time.



The Home screen disappears after 10 minutes of inactivity.

- "Screen Sharing" [p.163](#)

## ▶▶ Related Links

- "Image Quality Settings - Image Menu" [p.193](#)
- "Projector Installation Settings - Installation Menu" [p.198](#)
- "Image Shape" [p.62](#)
- "Using a QR Code to Connect a Mobile Device" [p.151](#)
- "Using the Projector's Menus" [p.191](#)
- "Projecting Two Images Simultaneously" [p.96](#)

Turn off the projector after use.



- Turn off this product when it is not in use to prolong the life of the projector. Light source life varies depending on the mode selected, environmental conditions, and usage. Brightness decreases over time.
- If the **Light Source Calibration** setting is set to **Run Periodically** in the projector's **Management** menu, light source calibration starts automatically if you turn off the projector and the following conditions are present:
  - 100 hours have passed since the last light source calibration
  - You have used the projector continuously for more than 20 minutes
- Since the projector supports the direct shutdown feature, it can be turned off directly using the breaker.

- 1** Press the power button on the control panel or remote control.  
The projector displays a shutdown confirmation screen.

Power Off?

Yes: Press  button

No : Press any other button

- 2** Press the power button again. (To leave it on, press any other button.)  
The projector beeps twice, the light source turns off, and the status indicator turns off.
- 3** To transport or store the projector, make sure the power indicator is blue (but not flashing) and the status indicator is off, then unplug the power cord.

- 4** Attach the lens cover.

You can set the date and time for the projector.



If the date and time are not correctly set on the projector, the AirPlay connection may be disconnected while projecting. Set the correct date and time in **Date & Time** and **Daylight Saving Time** from the **Management** menu.

- 1** Turn on the projector.
- 2** Press the [Menu] button on the control panel or remote control.
- 3** Select the **Management** setting and press [Enter].

Image	Customize Button	Not Set
Signal I/O	User's Logo	
Installation	Control Panel Lock	Off
Multi-Projection	Color Uniformity	
Display	Refresh Mode	
Operation	Light Source Calibration	
Management	Color Calibration	
Network	Date & Time	
Info	Schedule Settings	
Memory	NFC Settings	
ECO	Language	English
Initial/All Settings	Reset Management Settings	

- 4** Select the **Date & Time** setting and press [Enter].
- 5** Select the **Date & Time** setting and press [Enter].  
You see this screen:

[ Date & Time ]	Return
Date	2010-01-01
Time	00:00
Time Difference (UTC)	+
	00:00
	Set

- 6** Select **Date**, press [Enter], and use the displayed keyboard to enter today's date.
- 7** Select **Time**, press [Enter], and use the displayed keyboard to enter the current time.
- 8** Select **Time Difference (UTC)**, press [Enter], and set the time difference from Coordinated Universal Time.
- 9** When you are finished, select **Set** and press [Enter].

- 10** To activate daylight saving time, select the **Daylight Saving Time** setting and set it to **On**. Then select settings.

[ Daylight Saving Time ] Return

Daylight Saving Time	On	<input checked="" type="checkbox"/>	^
DST Adjustment (min)	0		
DST Start			
Month	1		
Week	1		
Day of the Week	Mon		
Time	00:00		
DST End			
Month	1		
Week	1		
Day of the Week	Mon		
Time	00:00		

Set

- 11** When you are finished, select **Set** and press [Enter].

- 12** To update the time automatically through an Internet time server, select the **Internet Time** setting and set it to **On**. Then select settings.

[ Use Internet Time ] Return

Use Internet Time	On	<input checked="" type="checkbox"/>	^
Internet Time Server	0.0.0.0		

Set

- 13** When you are finished, select **Set** and press [Enter].

- 14** Press [Menu] or [Esc] to exit the menus.

If you want to view the projector's menus and messages in another language, you can change the **Language** setting.

- 1** Turn on the projector.
- 2** Press the [Menu] button on the control panel or remote control.
- 3** Select the **Management** setting and press [Enter].

Image	Customize Button	Not Set
Signal I/O	User's Logo	
Installation	Control Panel Lock	Off
Multi-Projection	Color Uniformity	
Display	Refresh Mode	
Operation	Light Source Calibration	
Management	Color Calibration	
Network	Date & Time	
Info	Schedule Settings	
Memory	NFC Settings	
ECO	Language	English
Initial/All Settings	Reset Management Settings	

- 4** Select the **Language** setting and press [Enter].
- 5** Select the language you want to use and press [Enter].
- 6** Press [Menu] or [Esc] to exit the menus.

Depending on how you positioned the projector, you may need to change the projection mode so your images project correctly.

- **Front** lets you project from a table in front of the screen.
- **Front/Ceiling** flips the image over top-to-bottom to project upside-down from a ceiling or wall mount.
- **Rear** flips the image horizontally to project from behind a translucent screen.
- **Rear/Ceiling** flips the image over top-to-bottom and horizontally to project from a ceiling or wall mount and behind a translucent screen.

#### ▶ Related Links

- "Changing the Projection Mode Using the Remote Control" [p.54](#)
- "Changing the Projection Mode Using the Menus" [p.54](#)
- "Projector Setup and Installation Options" [p.29](#)

## Changing the Projection Mode Using the Remote Control

You can change the projection mode to flip the image over top-to-bottom.

- 1** Turn on the projector and display an image.
- 2** Hold down the [A/V Mute] button on the remote control for 5 seconds.

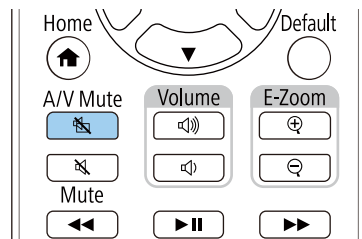

The image disappears briefly and reappears flipped top-to-bottom.

- 3** To change projection back to the original mode, hold down the [A/V Mute] button for 5 seconds again.

## Changing the Projection Mode Using the Menus

You can change the projection mode to flip the image over top-to-bottom and/or left-to-right using the projector menus.

- 1** Turn on the projector and display an image.
- 2** Press the [Menu] button on the control panel or remote control.
- 3** Select the **Installation** menu and press [Enter].

Image	Test Pattern	
Signal I/O	Projection	Front/Ceiling
Installation	Inv Direction Button	Off <input type="checkbox"/>
Multi-Projection	Geometry Correction	H/V-Keystone
Display	Remote Receiver	Off
Operation	Screen Type	16:9 <input type="checkbox"/>
Management	High Altitude Mode	Off <input type="checkbox"/>
Network	Blanking	
Info	Reset Installation Settings	
Memory		
ECO		
Initial/All Settings		

- 4** Select **Projection** and press [Enter].

- 5** Select a projection mode and press [Enter].

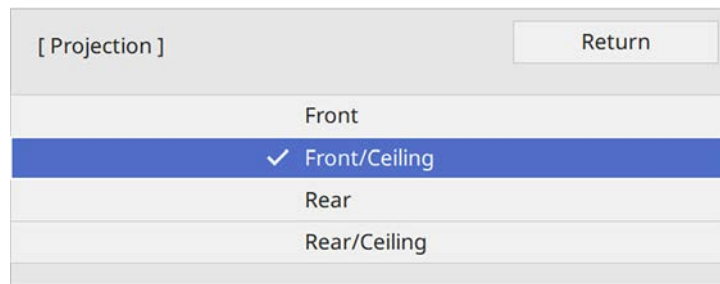

- 6** Press [Menu] or [Esc] to exit the menus.

You can use the **Screen Type** setting to match the aspect ratio of the displayed image to the screen you are using.



- You cannot change the **Screen Type** setting when the **Content Playback** setting is set to **On** in the projector's **Operation** menu.
- If you change the **Screen Type** setting, the **Geometry Correction** settings are initialized.

- 1 Turn on the projector and display an image.
- 2 Press the [Menu] button on the control panel or remote control.
- 3 Select the **Installation** menu and press [Enter].

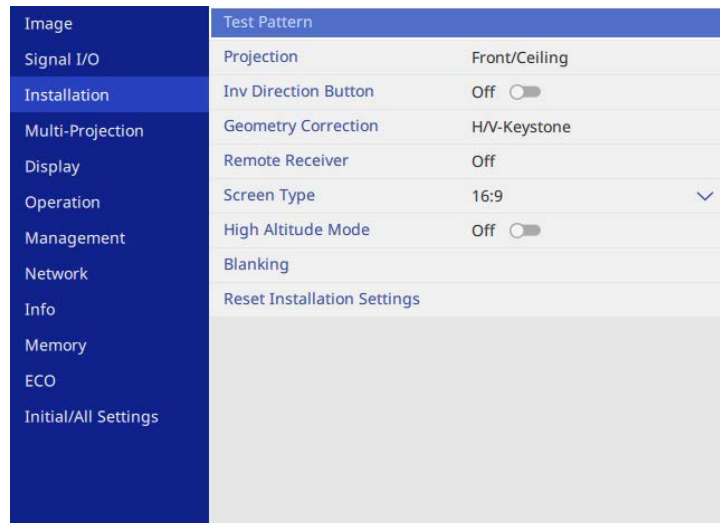

- 4 Select **Screen Type** and press [Enter].

- 5 Select your screen's aspect ratio and press [Enter].

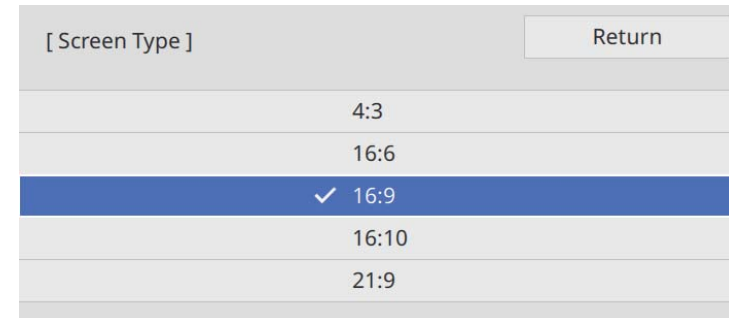

- 6 Press [Menu] to exit the menus.



You may need to restart the projector. Follow the on-screen instructions.

- 7 Adjust the aspect ratio for the projected image, if necessary.



When the **Screen Type** setting changes, the **EDID** settings are automatically adjusted.

### ▶▶ Related Links

- "Adjusting the Image Position Using Screen Position" [p.56](#)
- "Changing the Horizontal Position of the Image Using Screen Shift" [p.57](#)

## Adjusting the Image Position Using Screen Position

You can adjust the image position if there are margins between the edge of the image and the projected screen frame.





You cannot adjust the screen position if the **Screen Type** setting is set to **16:10**.

- 1** Turn on the projector and display an image.
- 2** Press the [Menu] button on the control panel or remote control.
- 3** Select the **Installation** menu and press [Enter].

Image	Test Pattern	
Signal I/O	Projection	Front/Ceiling
Installation	Inv Direction Button	Off <input type="checkbox"/>
Multi-Projection	Geometry Correction	H/V-Keystone
Display	Remote Receiver	Off
Operation	Screen Type	16:9 <input type="button" value="v"/>
Management	High Altitude Mode	Off <input type="checkbox"/>
Network	Blanking	
Info	Reset Installation Settings	
Memory		
ECO		
Initial/All Settings		

- 4** Select **Screen Position**, and press [Enter].

- 5** Use the arrow buttons on the control panel or remote control to adjust the position of the image.

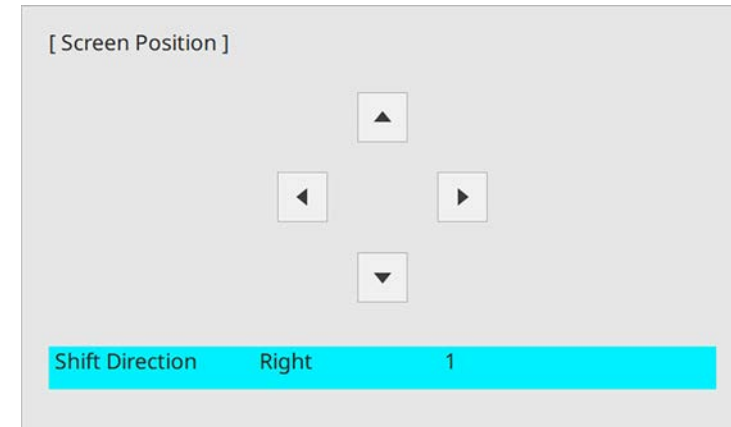

- 6** When you are finished, press [Menu].

## Changing the Horizontal Position of the Image Using Screen Shift

You can specify the horizontal position of the image inside the ultra-wide display when the **Screen Type** is set to **16:6**.

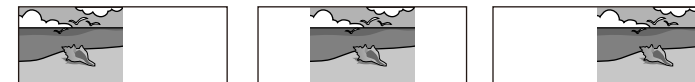

- Available only when **Aspect** is set to **Auto** for the HDMI and HDBaseT sources in the projector's **Image** menu.
- Unavailable in the split screen projection.

- 1** Turn on the projector and display an image.

- 2** Press the [4], [5], or [6] button on the remote control.
- 3** Adjust the horizontal position of the projected image by pressing the following numeric buttons on the remote control:
  - [4] to project the image in the left position.
  - [5] to project the image in the center.
  - [6] to project the image in the right position.

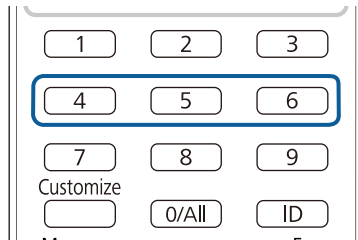

The setting is saved until the projector is turned off.

- 4** When you are finished, press [Esc].

If you cannot install the projector directly in front of the screen, you can adjust the position of the projected image using the lens shift feature.

### Attention

When adjusting the image position with the vertical lens shift, adjust it by moving the image from the bottom to the top. If you adjust it from the top to the bottom, the image position may move down slightly after adjusting.



- Wait 30 minutes after turning on the projector before setting the focus, zoom, and lens shift for maximum accuracy.
- Keep the vertical and horizontal lens shift dials in their center positions of the lens shift adjustment range for the clearest picture.

- 1 Turn on the projector and display an image.
- 2 Turn the vertical and horizontal lens shift dials on the projector to adjust the position of the projected image as necessary.

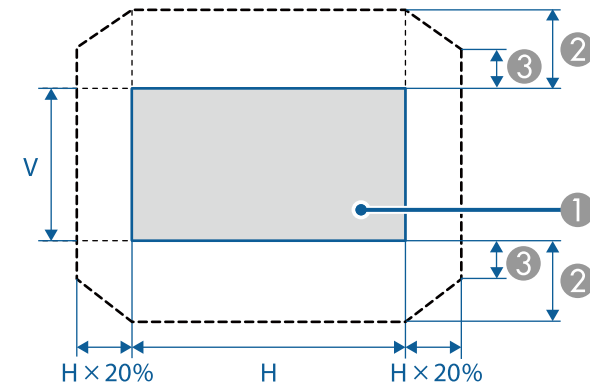
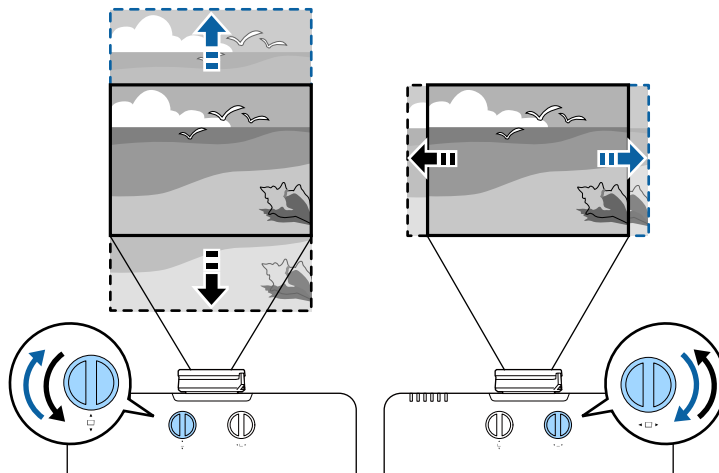

- 1 Projected image at the center of the lens shift adjustment range
- 2 Maximum range:  $V \times 50\%$
- 3 When the horizontal direction is at the maximum value:  $V \times 12\%$



- You cannot move the image horizontally when the lens is shifted vertically all the way.
- The lens shift adjustment range is an approximate value.

You can display a test pattern to adjust the projected image without connecting a computer or video device.



- The test pattern's shape is determined by the **Screen Type** setting. Be sure to set the correct screen type before adjusting with the test pattern.
- To set menu items that cannot be set while the test pattern is being displayed or to fine-tune the projected image, project an image from the connected device.
- If you capture the projected image as a test pattern during Freeze, you can use the captured image as one of the test patterns. The captured image is not 4K enhanced image quality.

**1** Turn on the projector.

**2** Press the down arrow button on the control panel.

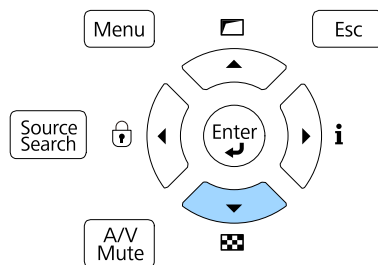

A test pattern is displayed.



You can also display a test pattern from the projector's **Installation** menu.

**3** Press the left or right arrow button on the remote control, or press [Enter] on the control panel to cycle through the available test patterns.

**4** Adjust the image as necessary.

**5** To remove the test pattern, press [Esc].

If you are projecting from a table or other flat surface and the image is too high or low, you can adjust the image height using the projector's adjustable feet.

The larger the angle of tilt, the harder it becomes to focus. Locate the projector so that it only needs to be tilted at a small angle.

**1** Turn on the projector and display an image.

**2** To adjust the image height, rotate the front foot to extend or retract it.

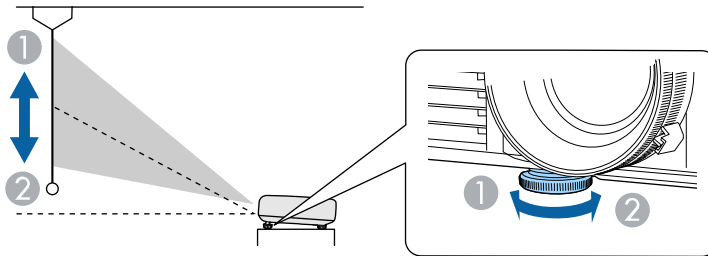

- 1 Extend the front foot
- 2 Retract the front foot

**3** If the image is tilted, rotate the rear feet to adjust their height.

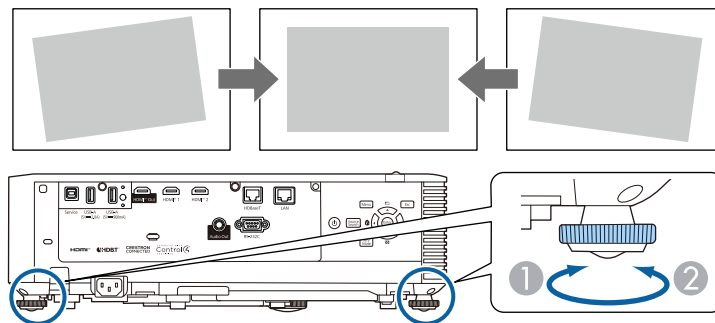

- 1 Extend the rear foot

**2** Retract the rear foot

If the projected image is unevenly rectangular, you need to adjust the image shape.

**► Related Links**

- "Image Shape" [p.62](#)

You can project an even, rectangular image by placing the projector directly in front of the center of the screen and keeping it level. If you place the projector at an angle to the screen, or tilt it up or down, or off to the side, you may need to correct the image shape.

After correction, your image is slightly smaller.

For the best quality images, we recommend adjusting the installation position of the projector to achieve the correct image size and shape.

► **Related Links**

- "Correcting Image Shape with H/V Keystone" [p.62](#)
- "Correcting the Image Shape with Quick Corner" [p.63](#)
- "Correcting Image Shape with Curved Surface Mode" [p.66](#)
- "Correcting Image Shape with Corner Wall Mode" [p.68](#)
- "Correcting Image Shape with Point Correction Mode" [p.71](#)
- "Loading Image Shape Setting from Memory" [p.74](#)

## Correcting Image Shape with H/V Keystone

You can use the projector's H/V-Keystone setting to correct the shape of an image that is unevenly rectangular on the sides.

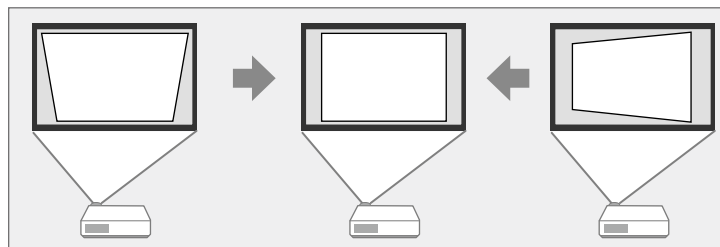

You can correct images up to 30° right, left, up, or down. (EB-L890E/EB-L895E/EB-L790SE/EB-L795SE/EB-L695SE/EB-L690E/EB-L890U/EB-L895U/EB-L790U/EB-L790SU/EB-L690U/EB-L690SU/EB-L695SU)

You can correct images up to 25° right, left, up, or down. (EB-L690SE)



- If you need to change the **Screen Type** and **Screen Position** settings, change them first.
- You cannot combine with other correction methods.

- 1** Turn on the projector and display an image.
- 2** Press the [Menu] button on the control panel or remote control.
- 3** Select the **Installation** menu and press [Enter].

Image	Test Pattern	
Signal I/O	Projection	Front/Ceiling
Installation	Inv Direction Button	Off <input type="checkbox"/>
Multi-Projection	Geometry Correction	H/V-Keystone
Display	Remote Receiver	Off
Operation	Screen Type	16:9 <input type="button" value="v"/>
Management	High Altitude Mode	Off <input type="checkbox"/>
Network	Blanking	
Info	Reset Installation Settings	
Memory		
ECO		
Initial/All Settings		

- 4** Select **Geometry Correction** and press [Enter].  
The **Geometry Correction** screen is displayed.



You can also access the **Geometry Correction** screen by pressing the up arrow button on the control panel.

- 5** Select **H/V-Keystone** and press [Enter]. Select **Yes** if necessary.  
You see the **H/V-Keystone** adjustment screen:

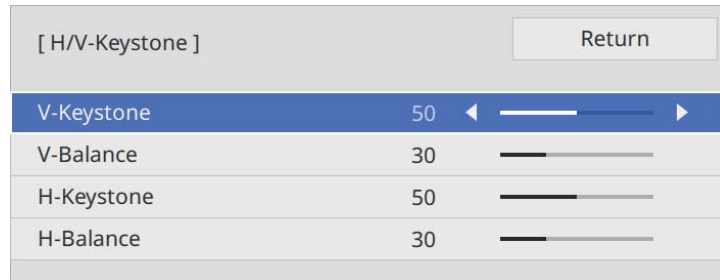

- 6** Use the arrow buttons on the projector or the remote control to select between vertical and horizontal keystone correction and to adjust the image shape as necessary.

• **V-Keystone**

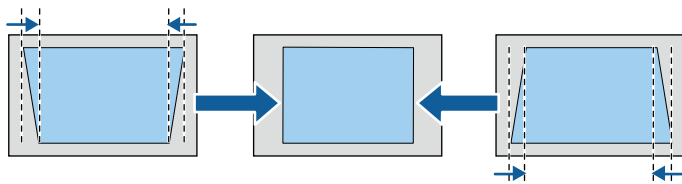

• **H-Keystone**

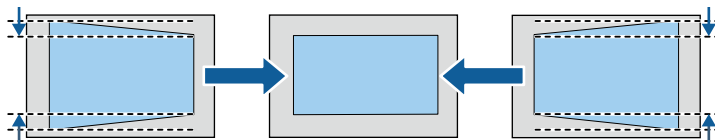

If you have adjusted the position of the projected image by using the lens shift feature, adjust the **V-Balance** and **H-Balance** settings as necessary.

• **V-Balance**

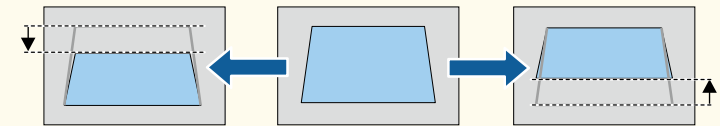

• **H-Balance**

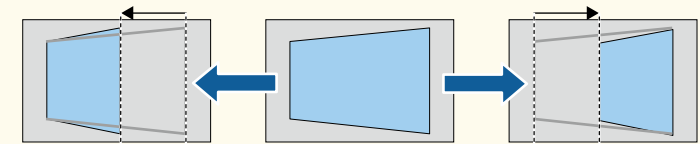

- 7** When you are finished, press [Esc].

After correction, your image is slightly smaller.



To save the current shape of an image you have adjusted, select **Save Memory**. You can save up to three image shapes in the memory.

☛ **Installation > Geometry Correction > Memory > Save Memory**

## Correcting the Image Shape with Quick Corner

You can use the projector's **Quick Corner** setting to correct the shape and size of an image that is unevenly rectangular.

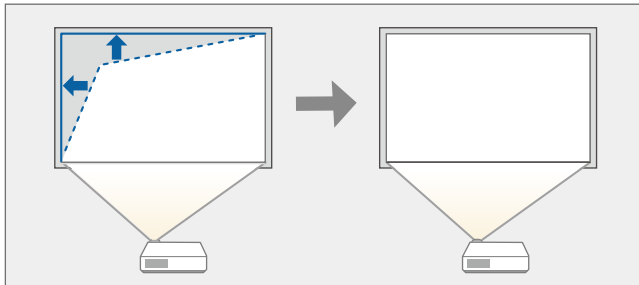

If you change the **Screen Type** and **Screen Position** settings, the adjustments are reset.

- 1** Turn on the projector and display an image.
- 2** Press the [Menu] button on the control panel or remote control.
- 3** Select the **Installation** menu and press [Enter].

Image	Test Pattern	
Signal I/O	Projection	Front/Ceiling
Installation	Inv Direction Button	Off <input type="checkbox"/>
Multi-Projection	Geometry Correction	H/V-Keystone
Display	Remote Receiver	Off
Operation	Screen Type	16:9 <input type="checkbox"/>
Management	High Altitude Mode	Off <input type="checkbox"/>
Network	Blanking	
Info	Reset Installation Settings	
Memory		
ECO		
Initial/All Settings		

- 4** Select **Geometry Correction** and press [Enter].  
You see the **Geometry Correction** screen.

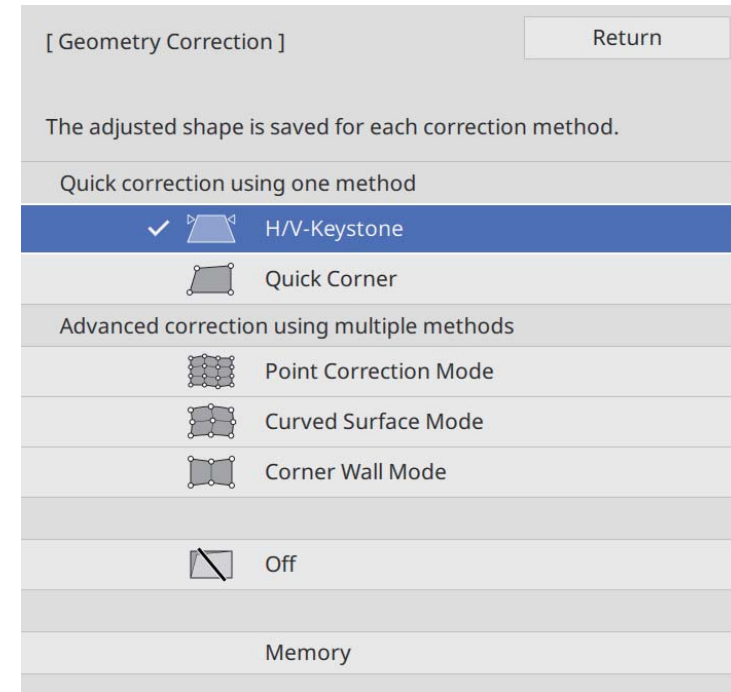

- 5** Select **Quick Corner** and press [Enter]. Select **Yes** if necessary.  
You see the area selection screen.



- 6** Use the arrow buttons to select the area of the image you want to adjust. Then press [Enter].

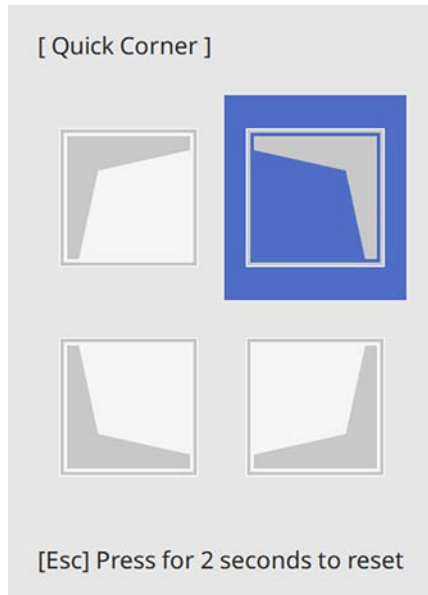

To reset the **Quick Corner** corrections, hold down [Esc] for about 2 seconds while the area selection screen is displayed, and then select Yes.

- 7** Press the arrow buttons to adjust the image shape as necessary. To return to the area selection screen, press [Enter].



- You can also select the area by pressing the following numeric buttons on the remote control:
  - [1] selects the upper left area.
  - [3] selects the upper right area.
  - [7] selects the lower left area.
  - [9] selects the lower right area.
- If you see this screen, you cannot adjust the shape any further in the direction indicated by the gray triangle.

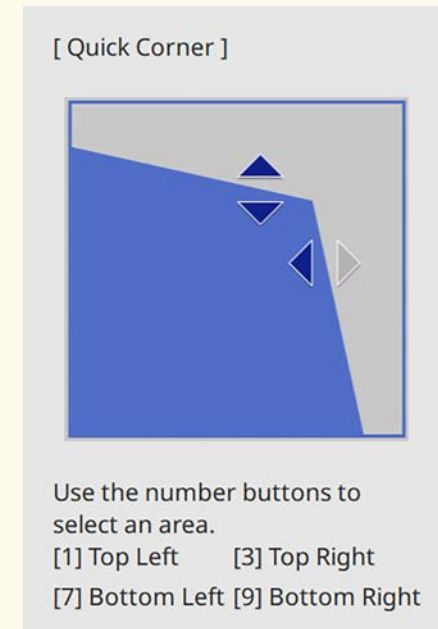

- 8** Repeat steps 6 and 7 as needed to adjust any remaining corners.

- 9** When you are finished, press [Esc].

The **Geometry Correction** setting is now set to **Quick Corner** in the projector's **Installation** menu.

The next time you press the up arrow button on the control panel, the area selection screen is displayed.



To save the current shape of an image you have adjusted, select **Save Memory**. You can save up to three image shapes in the memory.

☛ **Installation > Geometry Correction > Memory > Save Memory**

## Correcting Image Shape with Curved Surface Mode

You can use the projector's Curved Surface setting to adjust the shape of an image projected on a curved or spherical surface.

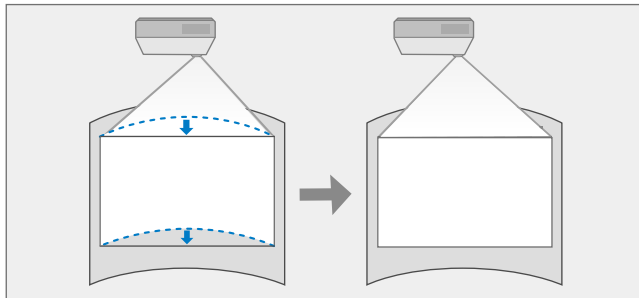

If you change the **Screen Type** and **Screen Position** settings, the adjustments are reset.

**1** Turn on the projector and display an image.

**2** Press the [Menu] button on the control panel or remote control.

**3** Select the **Installation** menu and press [Enter].

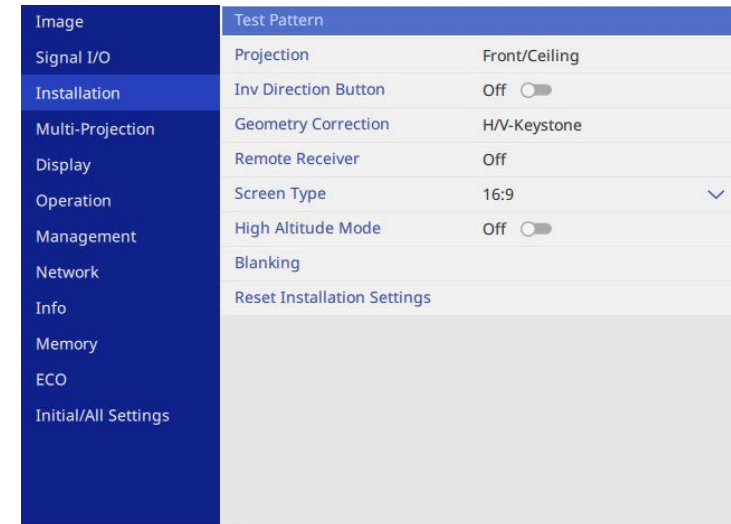

**4** Select **Geometry Correction** and press [Enter].  
You see the **Geometry Correction** screen.

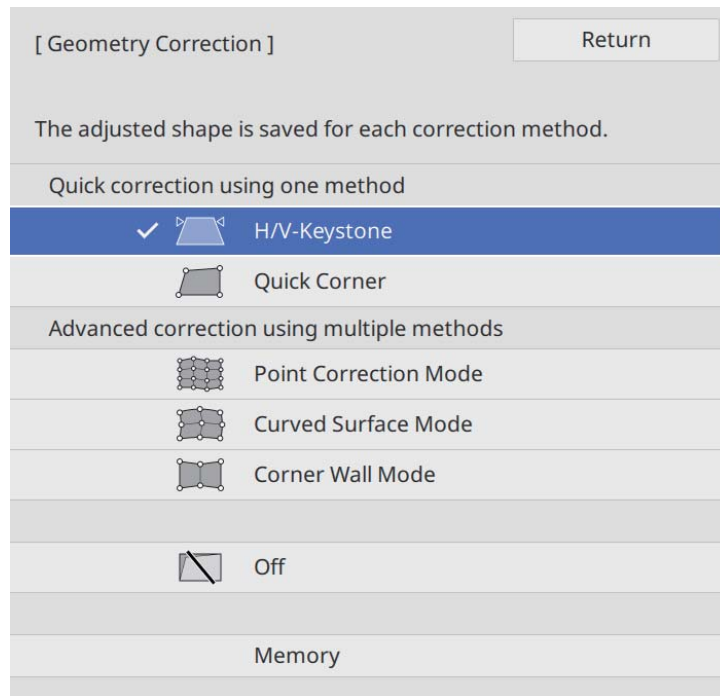

**5** Select **Curved Surface Mode** and press [Enter]. Select **Yes** if necessary.  
You see the **Curved Surface Mode** screen.

**6** Select **Curved Surface** and press [Enter].

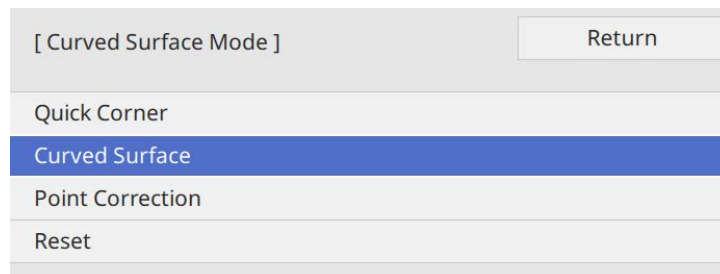

**7** Select **Correct Shape** and press [Enter].  
You see the area selection screen.

**8** Use the arrow buttons to select the area of the image you want to adjust, then press [Enter].

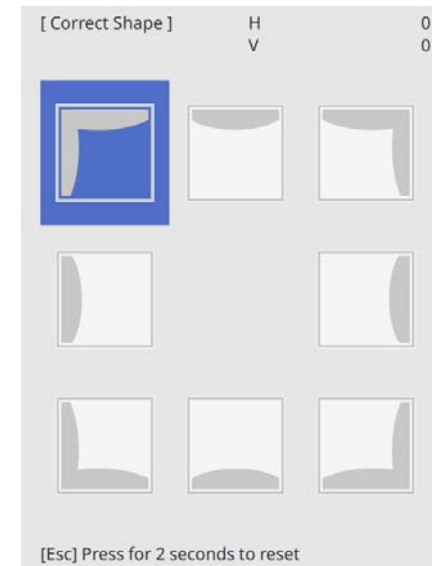

**9** Press the arrow buttons to adjust the image shape of the selected area as necessary.  
To return to the area selection screen, press [Esc].



If you see this screen, you cannot adjust the shape any further in the direction indicated by the gray triangle.

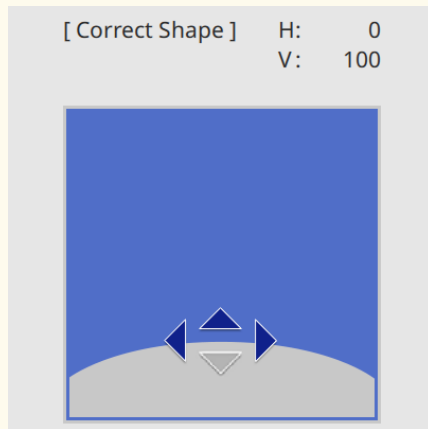

**10** Repeat steps 8 and 9 as needed to adjust any remaining corners.

**11** When you are finished, press [Esc].



- You can fine tune the corrected results. Use **Quick Corner** to adjust the tilt of the image, and then use **Point Correction** for fine tuning. Select **Quick Corner** or **Point Correction** on the screen in step 6.
- To save the current shape of an image you have adjusted, select **Save Memory**. You can save up to three image shapes in the memory.  
 ☛ **Installation > Geometry Correction > Memory > Save Memory**
- To reset the **Curved Surface** settings, hold down [Esc] for about 2 seconds while the area selection screen is displayed, and then select **Yes**.

## ► Related Links

- "Correcting the Image Shape with Quick Corner" [p.63](#)
- "Correcting Image Shape with Point Correction Mode" [p.71](#)

## Correcting Image Shape with Corner Wall Mode

You can use the projector's Corner Wall setting to correct the corners and sides of an image projected on a curved surface with right angles.

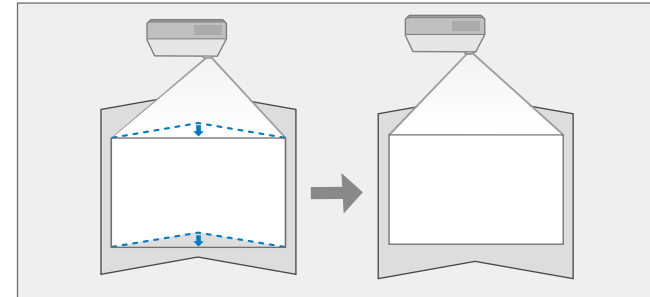

- If you change the **Screen Type** and **Screen Position** settings, the adjustments are reset.
- We recommend you adjust the image shape based on the point nearest to the center of the screen.

**1** Turn on the projector and display an image.

**2** Press the [Menu] button on the control panel or remote control.

**3** Select the **Installation** menu and press [Enter].

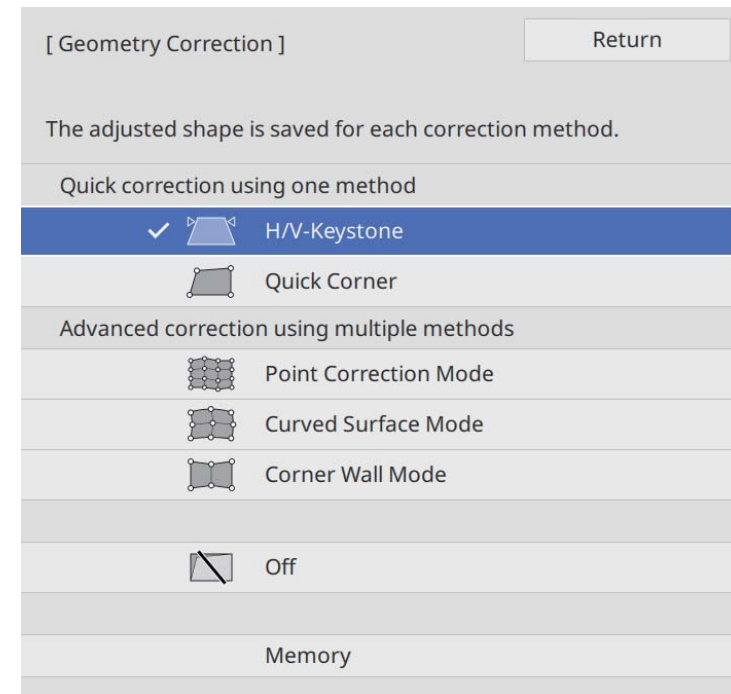
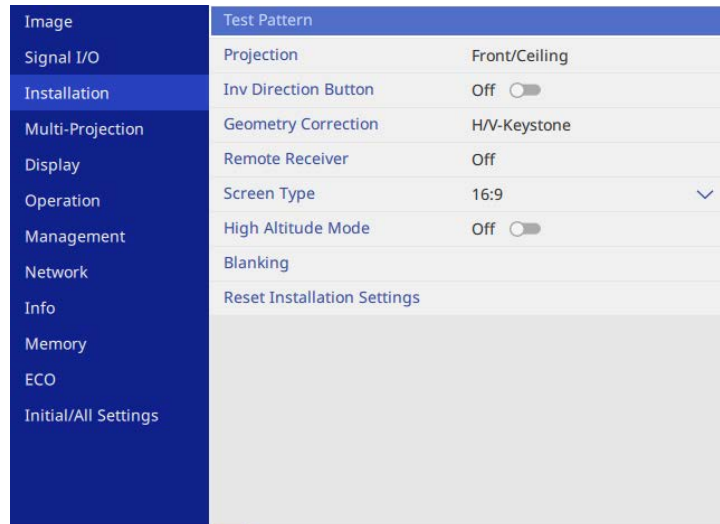

**4** Select **Geometry Correction** and press [Enter].  
You see the **Geometry Correction** screen.

**5** Select **Corner Wall Mode** and press [Enter]. Select **Yes** if necessary.  
You see the **Corner Wall Mode** screen.

**6** Select **Corner Wall** and press [Enter].

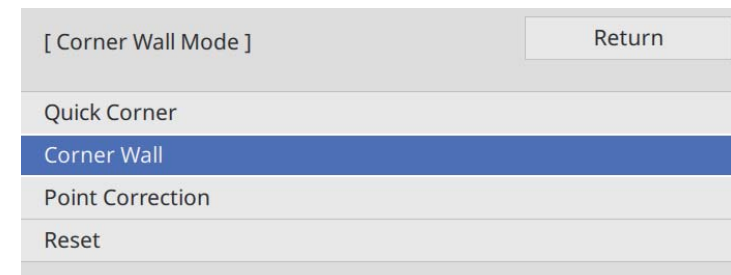

- 7** Select **Correct Shape** and press [Enter].  
You see the area selection screen.

- 8** Use the arrow buttons to select the area of the image you want to adjust, then press [Enter].

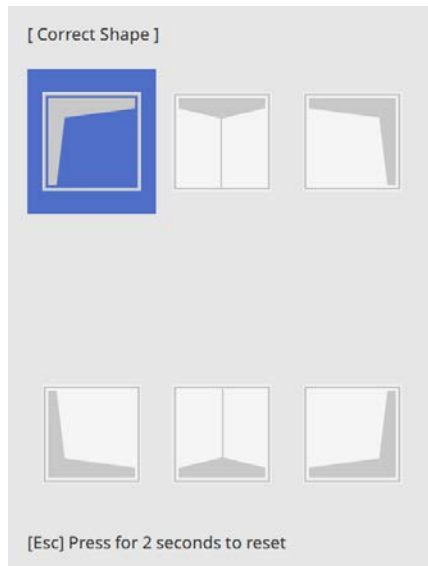

- 9** Press the arrow buttons to adjust the image shape of the selected area as necessary.  
To return to the area selection screen, press [Esc].



If you see this screen, you cannot adjust the shape any further in the direction indicated by the gray triangle.

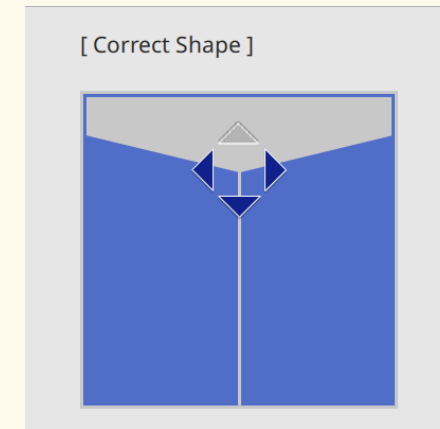

- 10** Repeat steps 8 and 9 as needed to adjust any remaining corners.
- 11** When you are finished, press [Esc].



- You can fine tune the corrected results. Use **Quick Corner** to adjust the tilt of the image, and then use **Point Correction** for fine tuning. Select **Quick Corner** or **Point Correction** on the screen in step 6.
- To save the current shape of an image you have adjusted, select **Save Memory**. You can save up to three image shapes in the memory.
  - **Installation > Geometry Correction > Memory > Save Memory**
- To reset the **Corner Wall** settings, hold down [Esc] for about 2 seconds while the area selection screen is displayed, and then select **Yes**.

## ▶▶ Related Links

- "Correcting the Image Shape with Quick Corner" [p.63](#)
- "Correcting Image Shape with Point Correction Mode" [p.71](#)

## Correcting Image Shape with Point Correction Mode

You can use the projector's **Point Correction** setting to fine-tune the image shape in portions of an image. The image is divided into a grid which allows you to move intersection points on the grid as necessary to correct distortion.

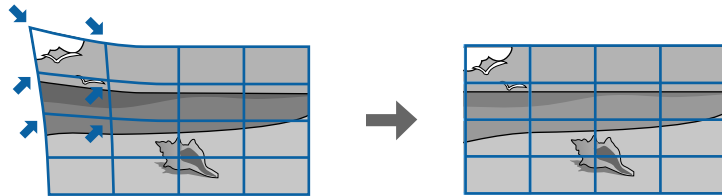

If you change the **Screen Type** and **Screen Position** settings, the adjustments are reset.

- 1 Turn on the projector and display an image.

- 2 Press the [Menu] button on the control panel or remote control.

- 3 Select the **Installation** menu and press [Enter].

Image	Test Pattern	
Signal I/O	Projection	Front/Ceiling
Installation	Inv Direction Button	Off <input type="checkbox"/>
Multi-Projection	Geometry Correction	H/V-Keystone
Display	Remote Receiver	Off
Operation	Screen Type	16:9 <input type="button" value="v"/>
Management	High Altitude Mode	Off <input type="checkbox"/>
Network	Blanking	
Info	Reset Installation Settings	
Memory		
ECO		
Initial/All Settings		

- 4 Select **Geometry Correction** and press [Enter].  
You see the **Geometry Correction** screen.

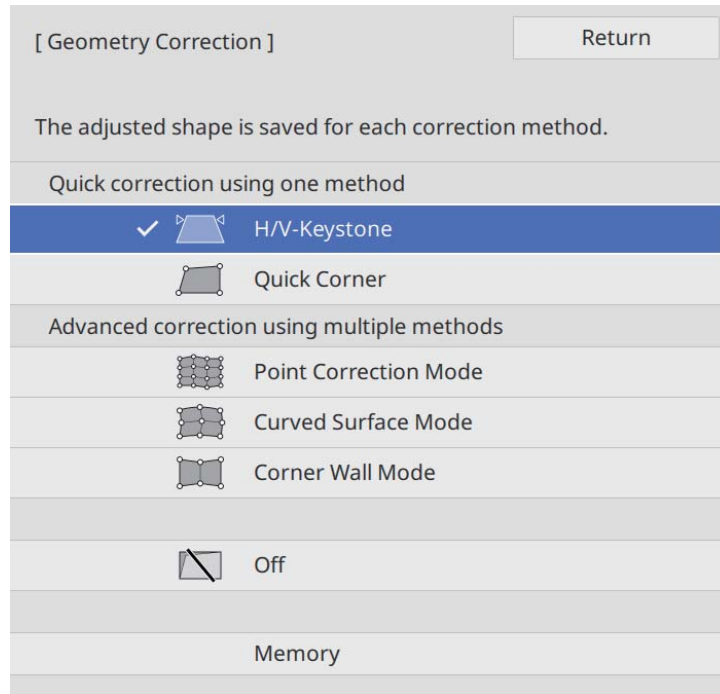

**5** Select **Point Correction Mode** and press [Enter]. Select **Yes** if necessary.

**6** Select **Point Correction** and press [Enter].

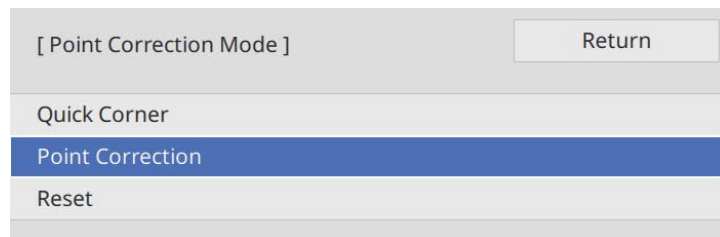

For fine tuning, select **Quick Corner** to correct the shape and size of an image roughly, and then select **Point Correction** to adjust them precisely.

**7** Select **Point Correction** and press [Enter].

You see the grid on the projected image.



- If you want to change the point number, press [Esc], then select a different **Grid Size** setting in the **Point Correction** menu.
- If you want to change the grid color for visibility, press [Esc], then select a different **Pattern Color** setting in the **Point Correction** menu.

**8** If you want to correct one point at a time, use the arrow buttons to move to the point you want to correct, then press [Enter].

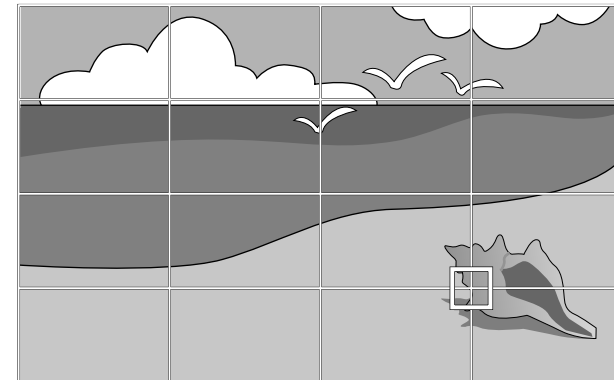



- 9** Use the arrow buttons to correct distortion as necessary.

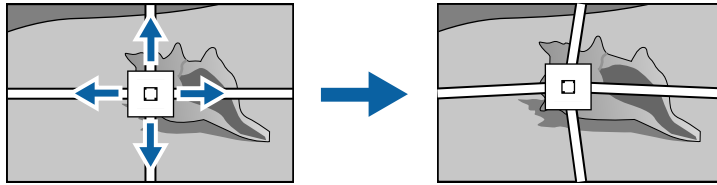

- 10** If you want to correct all points in a specified vertical column or horizontal row at once, hold down the [Enter] button for two seconds.

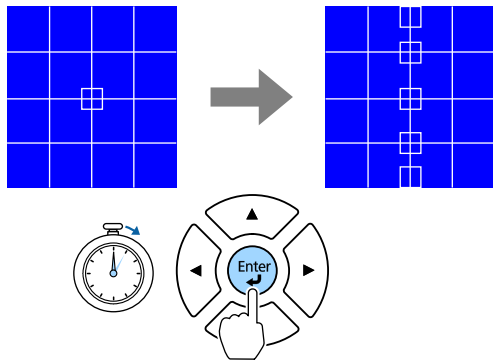

- 11** Use the left and right arrow buttons to select the column you want to adjust, and then press [Enter].

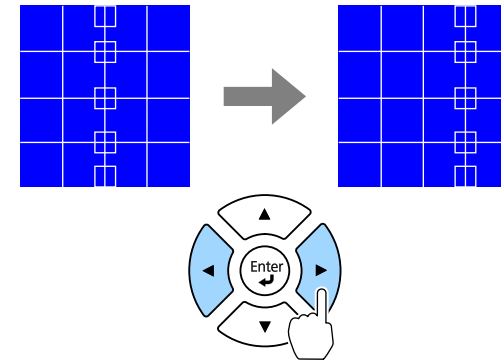

- 12** Use the up and down arrow buttons to select the row you want to adjust, and then press [Enter].

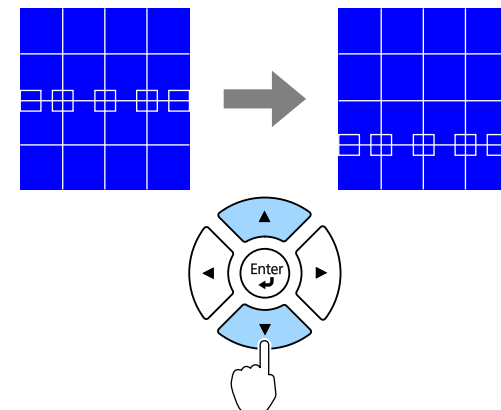

- 13** To correct any remaining points, press [Esc] to return to the previous screen, then repeat steps 8 to 12.

- 14** When you are finished, press [Esc].



- To save the current shape of an image you have adjusted, select **Save Memory**. You can save up to three image shapes in the memory.
  - **Installation > Geometry Correction > Memory > Save Memory**
- To reset the **Point Correction** settings to their original positions, select **Reset** on the **Point Correction** screen.



- The illustration above is only an example.
- You can also load the saved image shape settings by selecting **Load Memory** in the **Memory** menu.

- 3** When you have finished loading the settings, follow the on-screen instructions.

## Loading Image Shape Setting from Memory

You can load the image shape settings you selected and saved to the projector's memory and apply them to the current image.

- 1** Turn on the projector and display an image.
- 2** Press the numeric button (1, 2, or 3) on the remote control that matches the number of the saved setting.

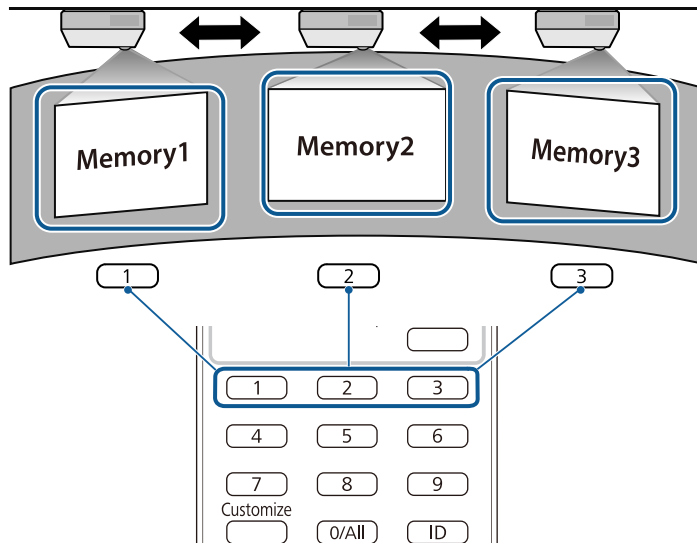

You can resize the image using the projector's zoom ring.



Wait 30 minutes after turning on the projector before setting the focus, zoom, and lens shift for maximum accuracy.

- 1** Turn on the projector and display an image.
- 2** Rotate the zoom ring to enlarge or reduce the image.  
EB-L890E/EB-L895E/EB-L690E/EB-L890U/EB-L895U/EB-L790U/EB-L690U

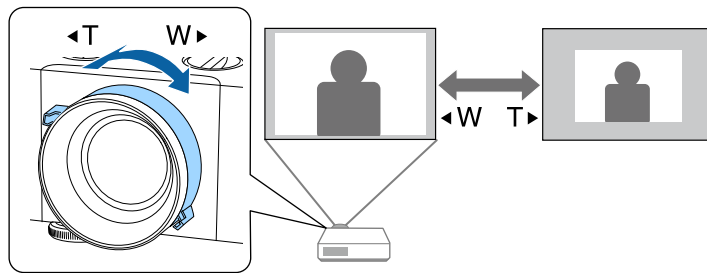
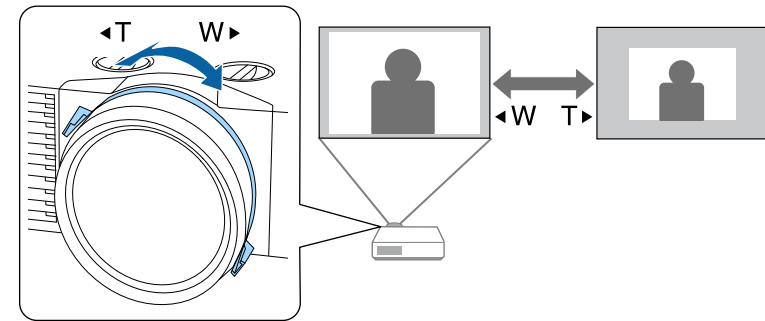

EB-L790SE/EB-L795SE/EB-L790SU/EB-L690SU/EB-L695SU

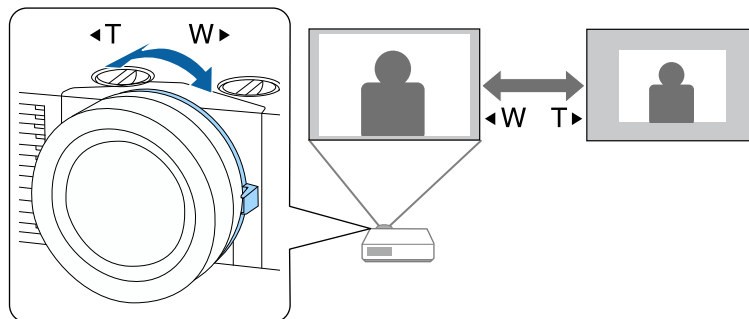

EB-L690SE/EB-L695SE

You can correct the focus using the focus ring. (EB-L890E/EB-L895E/EB-L690E/EB-L890U/EB-L895U/EB-L790U/EB-L690U)



Wait 30 minutes after turning on the projector before setting the focus, zoom, and lens shift for maximum accuracy.

Turn the focus ring to focus the entire screen.

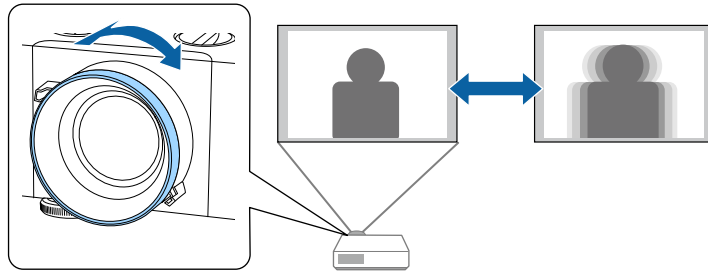

You can correct the focus using the center focus ring and corner focus ring. (EB-L790SE/EB-L795SE/EB-L690SE/EB-L695SE/EB-L790SU/EB-L690SU/EB-L695SU)



Wait 30 minutes after turning on the projector before setting the focus, zoom, and lens shift for maximum accuracy.

**1** Adjust the center focus while looking at the center of the projection screen.

EB-L790SE/EB-L795SE/EB-L790SU/EB-L690SU/EB-L695SU

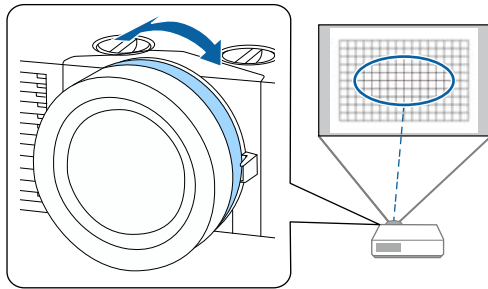

EB-L690SE/EB-L695SE

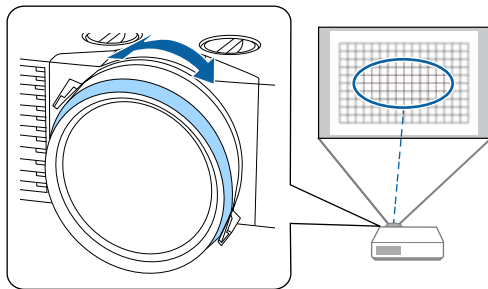

**2** Adjust the corner focus while looking at the four corners of the projection screen.

EB-L790SE/EB-L795SE/EB-L790SU/EB-L690SU/EB-L695SU

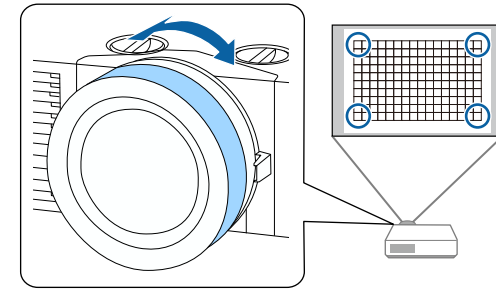

EB-L690SE/EB-L695SE

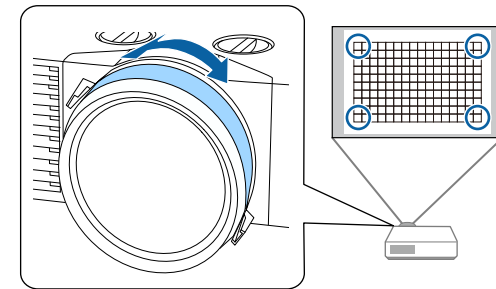

**3** If the image is still not focused, repeat steps 1 and 2 to adjust it again.

►► **Related Links**

- "Projector Parts - Front/Top" [p.19](#)

When multiple image sources are connected to the projector, such as a computer and DVD player, you can switch from one image source to the other.

- 1** Make sure the connected image source you want to use is turned on.
- 2** For video image sources, insert a DVD or other video media and press play.
- 3** Do one of the following:
  - Press the [Source Search] button on the control panel or remote control until you see the image from the source you want.

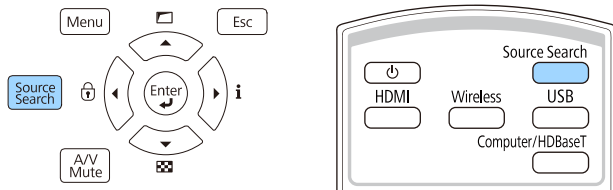

This screen is displayed when no image signal is detected. Check the cable connections between the projector and image source.

[ Source Search ]	
Signal Status	
HDMI1	Off
HDMI2	Off
HDBaseT	Off
USB	
AirPlay	
Miracast1	Off
Miracast2	Off
LAN	Off

Input an image signal.  
Press to select the source.

- Press the button for the source you want on the remote control. If there is more than one port for that source, press the button again to cycle through the sources.

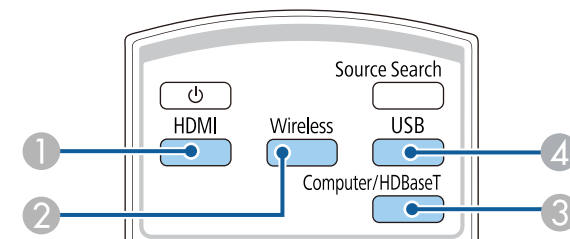

- 1** HDMI sources (HDMI1 and HDMI2 ports)
- 2** Network source (AirPlay, Miracast, and LAN)
- 3** Computer/HDBaseT port source (HDBaseT port)

## 4 USB port source

- Press the [Home] button on the remote control.

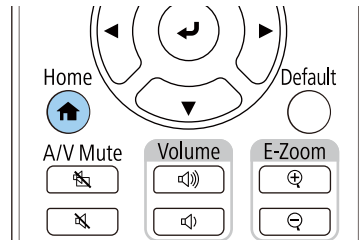

Then select the source you want to use from the screen displayed.

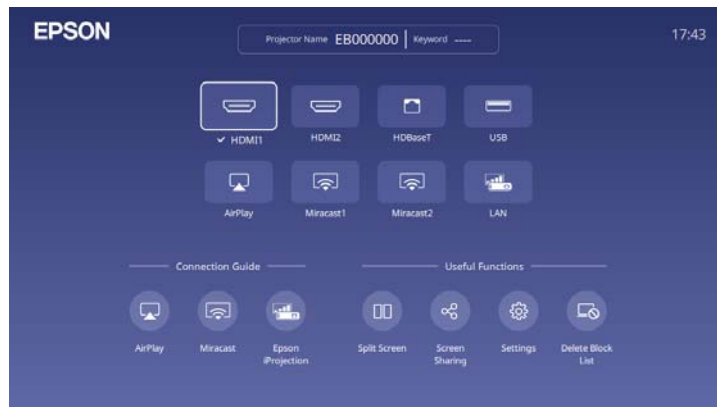

- The display order of the input sources changes when the projector detects an input signal. (The detected input source appears in the upper left position.)
- A check mark appears on the image from the current input source. You can check a preview of the current input image for most sources as a thumbnail (other than the USB input source in Content Playback mode).

## ▶▶ Related Links

- "Projector Parts - Remote Control" [p.24](#)

The projector can display images in different width-to-height ratios called aspect ratios. Normally, the input signal from your video source determines the image's aspect ratio. However, you can change the aspect ratio for certain images to fit your screen.

## ► Related Links

- "Changing the Image Aspect Ratio" [p.80](#)
- "Available Image Aspect Ratios" [p.81](#)

## Changing the Image Aspect Ratio

You can change the aspect ratio of the displayed image.



- Set the **Screen Type** setting in the projector's **Installation** menu before changing the aspect ratio.
  - Available only when using one of the following input sources:
    - HDMI
    - HDBaseT
  - Available only when the **Scale** setting is turned off or the **Scale Mode** setting is set to **Full Display**.
- 🖱️ **Image > Scale > Scale Mode**

- 1** Turn on the projector and switch to the image source you want to use.
- 2** Press the [Menu] button on the control panel or remote control.

- 3** Select the **Image** menu and press [Enter].

Image	Color Mode	Dynamic
Signal I/O	Image Adjustment	☀️ 50 🌑 50 🌒 50 🌒 50
Installation	Sharpness	
Multi-Projection	White Balance	
Display	Dynamic Contrast	Off
Operation	Image Enhancement	
Management	Scene Adaptive Gamma	0
Network	Gamma	
Info	RGBCMY	
Memory	Reset to Defaults	
ECO	Aspect	Auto
Initial/All Settings	Scale	
	Reset Image Settings	

- 4** Select **Aspect** and press [Enter].
- 5** Select the aspect ratio for your input signal.
- 6** Press [Menu] or [Esc] to exit the menus.



- The available aspect ratio setting varies depending on the input signal.
  - If there are margins between the edge of the image and the projected screen frame, you can adjust the position of the image using the **Screen Position** setting in the projector's **Installation** menu.
- 🖱️ **Installation > Screen Position**

## ► Related Links

- "Image Quality Settings - Image Menu" [p.193](#)
- "Projector Installation Settings - Installation Menu" [p.198](#)



## Available Image Aspect Ratios

You can select the following image aspect ratios, depending on the selected **Screen Type** setting and the input signal from your image source.



Note that using the aspect ratio function of the projector to reduce, enlarge, or split the projected image for commercial purposes or for public viewing may infringe upon the rights of the copyright holder of that image based on copyright law.

Aspect mode	Description
Auto	Automatically sets the aspect ratio according to the input signal.
4:3 (Available when <b>Screen Type</b> is set to 4:3)	Converts the aspect ratio of the image to 4:3.
16:9 (Available when <b>Screen Type</b> is set to 4:3 or 16:10)	Converts the aspect ratio of the image to 16:9.
Full (Available when <b>Screen Type</b> is set to 16:6, 16:9, 16:10 or 21:9)	Displays images using the full size of the projection area, but does not maintain the aspect ratio.
H-Zoom V-Zoom (Available when <b>Screen Type</b> is set to 4:3, 16:9, 16:10 or 21:9)	Displays images using the full width (H-Zoom) or full height (V-Zoom) of the projection area and maintains the aspect ratio of the image. Areas that exceed the edges of the projected screen are not projected.
Native (Available when <b>Screen Type</b> is set to 4:3, 16:9, 16:10 or 21:9)	Displays images as is (aspect ratio and resolution are maintained). Areas that exceed the edges of the projected screen are not projected.

The projector offers different color modes to provide optimum brightness, contrast, and color for a variety of viewing environments and image types. You can select the mode designed to match your image and environment, or experiment with the available modes.

► **Related Links**

- "Changing the Color Mode" [p.82](#)
- "Available Color Modes" [p.82](#)

## Changing the Color Mode

You can change the projector's Color Mode using the remote control to optimize the image for your viewing environment.

- 1 Turn on the projector and switch to the image source you want to use.
- 2 Press the [Menu] button on the control panel or remote control.
- 3 Select the **Image** menu and press [Enter].

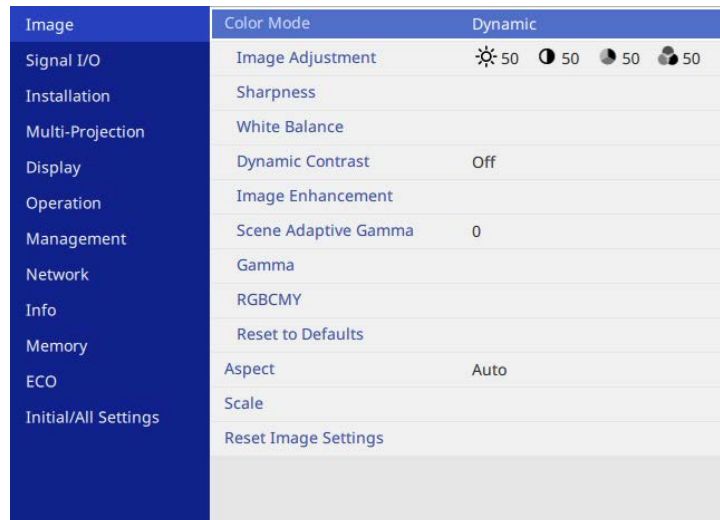

- 4 Select **Color Mode** and press [Enter].
- 5 Select the color mode for your input signal.
- 6 Press [Menu] or [Esc] to exit the menus.

► **Related Links**

- "Image Quality Settings - Image Menu" [p.193](#)
- "Multiple Projector Operation Settings - Multi-Projection Menu" [p.200](#)

## Available Color Modes

You can set the projector to use these color modes, depending on the input source you are using:

Color mode	Description
Dynamic	This is the brightest mode. Best for prioritizing brightness.
Presentation	Best for projecting vivid images.
Natural	Reproduces colors faithfully. Ideal for projecting still pictures such as photos.
Cinema	Best for enjoying content such as movies.
BT.709	Produces images that conform to the ITU-R BT.709.
DICOM SIM	Best for projecting X-ray photographs and other medical images. This mode is for reference purposes only and should not be used to make medical diagnoses.
Multi-Projection	Best for projecting from multiple projectors (reduces the color tone difference between images).

You can turn on Dynamic Contrast to automatically optimize the image luminance. This improves the image contrast based on the brightness of the content you project.

- 1 Turn on the projector and switch to the image source you want to use.
- 2 Press the [Menu] button on the control panel or remote control.
- 3 Select the **Image** menu and press [Enter].

Image	Color Mode	Dynamic
Signal I/O	Image Adjustment	☀ 50 ● 50 ● 50 ● 50
Installation	Sharpness	
Multi-Projection	White Balance	
Display	Dynamic Contrast	Off
Operation	Image Enhancement	
Management	Scene Adaptive Gamma	0
Network	Gamma	
Info	RGBCMY	
Memory	Reset to Defaults	
ECO	Aspect	Auto
Initial/All Settings	Scale	
	Reset Image Settings	

- 4 Select **Dynamic Contrast** and press [Enter].
- 5 Choose one of the following options and press [Enter]:
  - **Normal** for standard brightness adjustment using minimal brightness changes.
  - **High Speed** to adjust brightness as soon as the scene changes. Brightness changes significantly.

- **ECO** to adjust brightness while minimizing power consumption without compromising image quality.

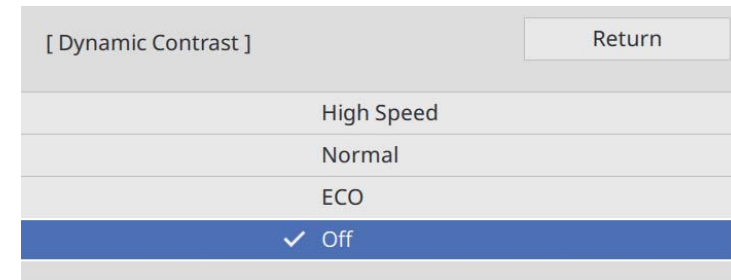

- 6 Press [Menu] or [Esc] to exit the menus.

You can fine-tune various aspects of how colors are displayed in your projected images.

## ▶ Related Links

- "Adjusting the Hue, Saturation, and Brightness" [p.84](#)
- "Adjusting the Gamma" [p.85](#)

## Adjusting the Hue, Saturation, and Brightness

You can adjust the Hue, Saturation, and Brightness settings for individual image colors.

- 1** Turn on the projector and switch to the image source you want to use.
- 2** Press the [Menu] button on the control panel or remote control.
- 3** Select the **Image** menu and press [Enter].

Image	Color Mode	Dynamic
Signal I/O	Image Adjustment	☀ 50 ● 50 ● 50 ● 50
Installation	Sharpness	
Multi-Projection	White Balance	
Display	Dynamic Contrast	Off
Operation	Image Enhancement	
Management	Scene Adaptive Gamma	0
Network	Gamma	
Info	RGBCMY	
Memory	Reset to Defaults	
ECO	Aspect	Auto
Initial/All Settings	Scale	
	Reset Image Settings	

- 4** Select RGBCMY and press [Enter].

- 5** Select the color to adjust, and press [Enter].

[ RGBCMY ]		Return	
	Hue	Saturation	Brightness
R	50	50	50
G	50	50	50
B	50	50	50
C	50	50	50
M	50	50	50
Y	50	50	50

- 6** Do the following as necessary for each setting:

- To adjust the overall hue of the color, bluish - greenish - reddish, adjust the **Hue** setting.
- To adjust the overall vividness of the color, adjust the **Saturation** setting.
- To adjust the overall color brightness of the color, adjust the **Brightness** setting.

[ R ]		Return
Hue	50	M ◀ ◯ ▶ Y
Saturation	50	◯
Brightness	50	◯

- 7** Press [Menu] or [Esc] to exit the menus.

## Adjusting the Gamma

You can correct differences in projected image colors that occur between different image sources by adjusting the Gamma setting.



To optimize the color tone according to the scene, and to obtain a more vivid image, correct the image by adjusting the **Scene Adaptive Gamma** setting.

- 1** Turn on the projector and switch to the image source you want to use.
- 2** Press the [Menu] button on the control panel or remote control.
- 3** Select the **Image** menu and press [Enter].

Image	Color Mode	Dynamic
Signal I/O	Image Adjustment	☀️ 50 🌑 50 🌒 50 🌓 50
Installation	Sharpness	
Multi-Projection	White Balance	
Display	Dynamic Contrast	Off
Operation	Image Enhancement	
Management	Scene Adaptive Gamma	0
Network	Gamma	
Info	RGBCMY	
Memory	Reset to Defaults	
ECO	Aspect	Auto
Initial/All Settings	Scale	
	Reset Image Settings	

- 4** Select **Gamma** and press [Enter].

- 5** Adjust the correction value for the **Gamma** setting and press [Enter].

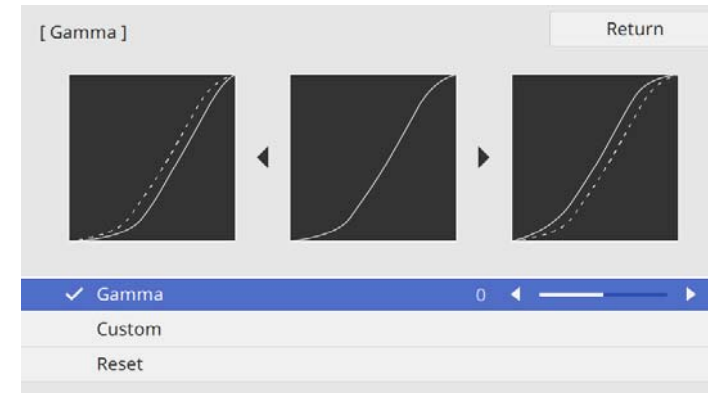

When you select a smaller value, you can reduce the overall brightness of the image to make the image sharper. When you select a larger value, the dark areas of images become brighter, but the color saturation for lighter areas may become weaker.

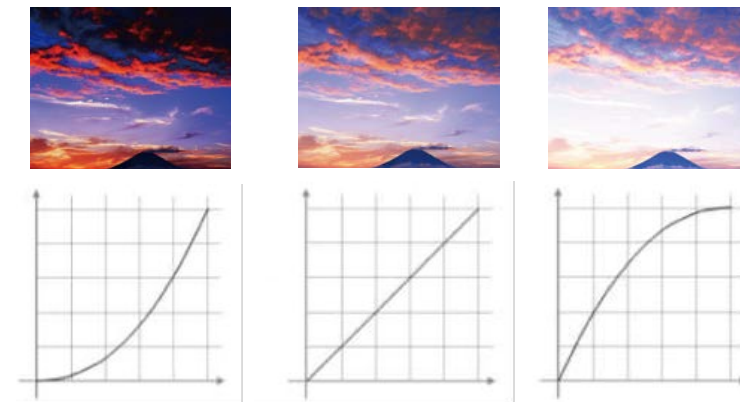



- If you set the **Color Mode** setting to anything other than **Dynamic** or **DICOM SIM** in the projector's **Image** menu, the gamma setting method is reversed.  
When you select a larger value, you can reduce the overall brightness of the image to make the image sharper. When you select a smaller value, the dark areas of images become brighter, but the color saturation for lighter areas may become weaker.
- If you set the **Color Mode** setting to **DICOM SIM** in the projector's **Image** menu, select the adjustment value according to the projection size.
  - If the projection size is 120 inches or less, select a small value.
  - If the projection size is 120 inches or more, select a large value.
- Medical images may not be reproduced correctly depending on your settings and screen specifications.

**6** If you want to make finer adjustments, select **Custom** and press [Enter].

**7** Press the left or right arrow buttons to select the color tone you want to adjust on the gamma adjustment graph. Then press the up or down arrow button to adjust the value and press [Enter].

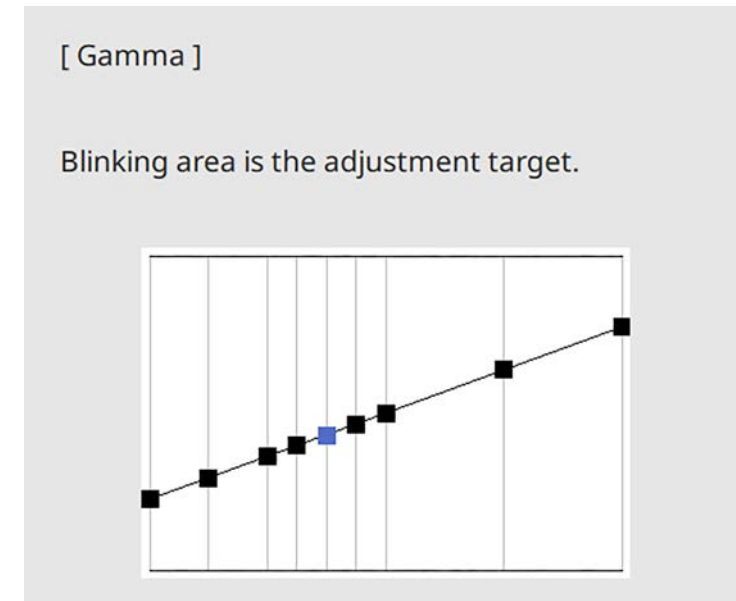

**8** Press [Menu] or [Esc] to exit the menus.

#### ▶▶ Related Links

- "Image Quality Settings - Image Menu" [p.193](#)

You can adjust the resolution of the image to reproduce a clear image with an emphatic texture and material feel.

- 1 Turn on the projector and switch to the image source you want to use.
- 2 Press the [Menu] button on the control panel or remote control.
- 3 Select the **Image** menu and press [Enter].

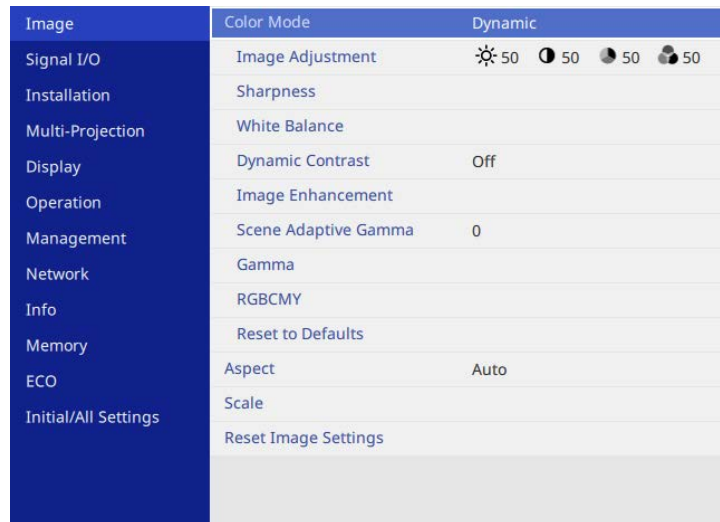

- 4 Select **Image Enhancement** and press [Enter].

- 5 Select **Image Preset Mode** and press [Enter].

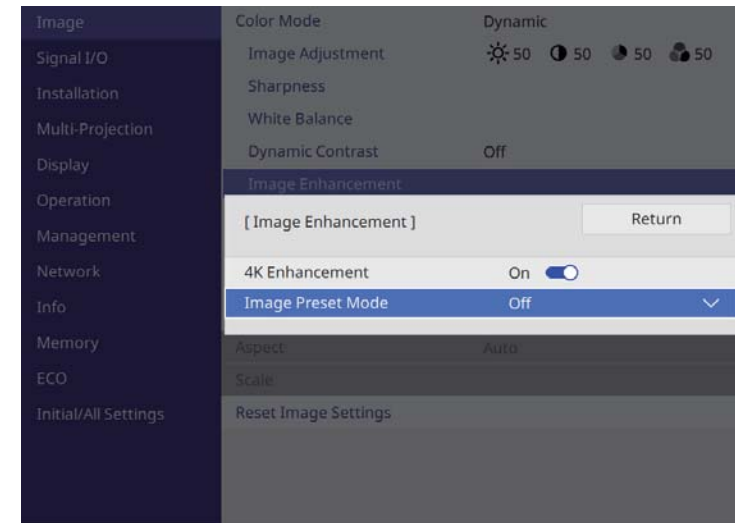

- 6 Select the preset option and press [Enter].

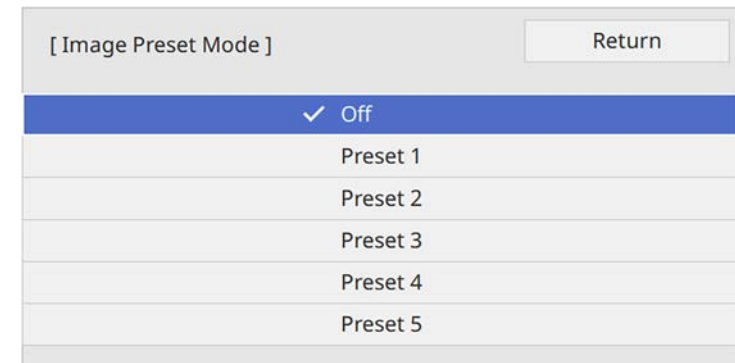

The following settings saved in the preset option are applied to the image.

- **Noise Reduction**
- **MPEG Noise Reduction**

- **Detail Enhancement**

- 7** Adjust each setting individually as necessary.
  - To reduce flickering in images, adjust the **Noise Reduction** setting.
  - To reduce the noise or artifacts seen in MPEG video, adjust the **MPEG Noise Reduction** setting.
  - To create a more emphatic texture and material feel of the image, adjust the **Detail Enhancement** setting.



The settings value in the preset option are overwritten.

- 8** Press [Menu] or [Esc] to exit the menus.



You can adjust the brightness of your projector's light source.

- 1 Turn on the projector and switch to the image source you want to use.
- 2 Press the [Menu] button on the control panel or remote control.
- 3 Select the **Operation** menu and press [Enter].

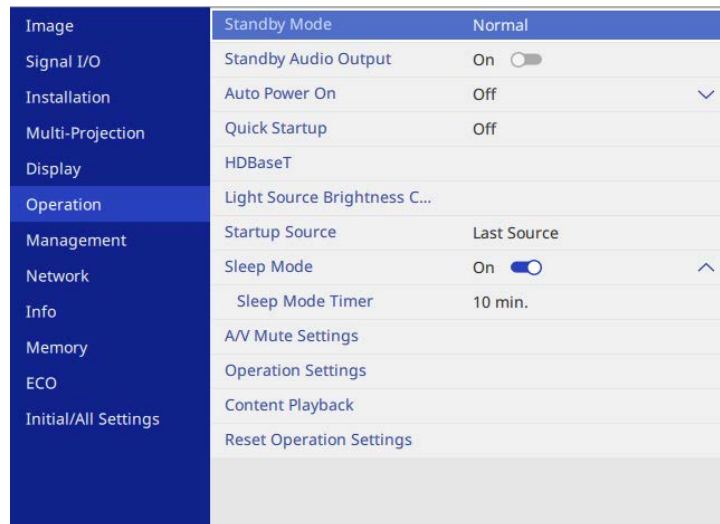

- 4 Select **Light Source Brightness Control** and press [Enter].

- 5 If you want to maintain the brightness at a specific level, select the **Maintain Brightness** setting and select **On**.

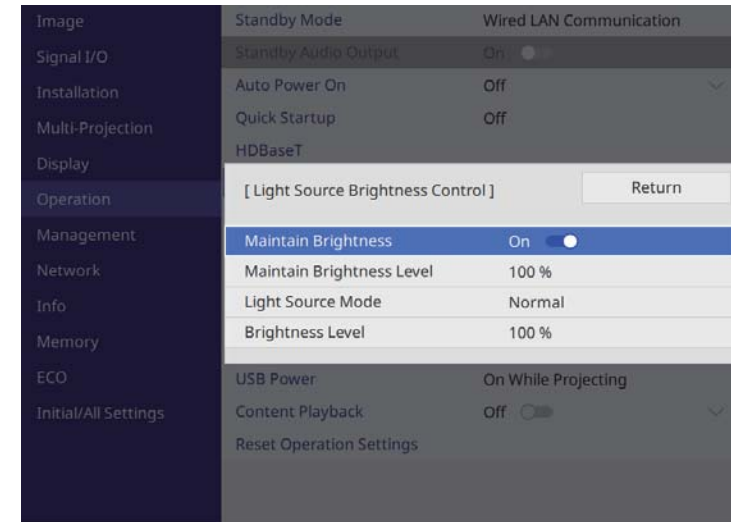

- 6 If you turn off **Maintain Brightness**, select the **Light Source Mode** setting:
  - **Normal** lets you set the brightness to the maximum level. This makes the light source operation time approximately 20,000 hours.
  - **Quiet** lets you set the brightness to 70% and reduces fan noise. This makes the light source operation time approximately 20,000 hours.
  - **Extended** lets you set the brightness to 70% and extends the life expectancy of the light source. This makes the light source operation time approximately 30,000 hours.
  - **Custom** lets you to select a custom brightness level between 70 to 100%.

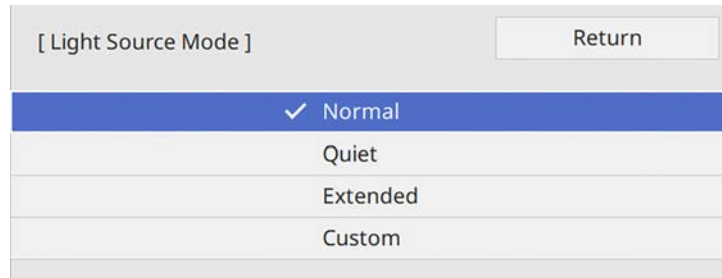

**7** If you set the **Light Source Mode** setting to **Custom**, select **Brightness Level** and use the left and right arrow buttons to select the brightness.

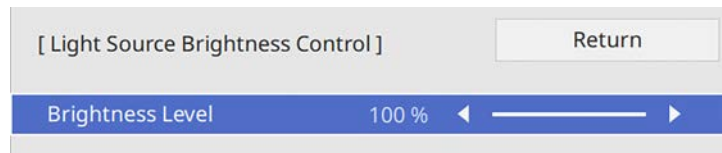

**8** Press [Menu] or [Esc] to exit the menus.



For the best results in maintaining a constant brightness, set the **Light Source Calibration** setting to **Run Periodically** in the projector's **Management** menu.

**▶ Related Links**

- "Light Source Operation Time" p.90



- The light source operation time varies depending on the environmental conditions and usage.
- The hours listed here are an approximate and are not guaranteed.
- You may need to replace internal parts sooner than the estimated light source operation time.
- If **Maintain Brightness** is turned on, and you have exceeded the usage hours listed here, you may not be able to select a high **Maintain Brightness Level** setting.

**Maintain Brightness off**

Brightness Level setting	Time before the brightness of the light source is reduced by half (approximate)
100%	20,000 hours
90%	21,000 hours
80%	24,000 hours
70%	30,000 hours

**Maintain Brightness on**

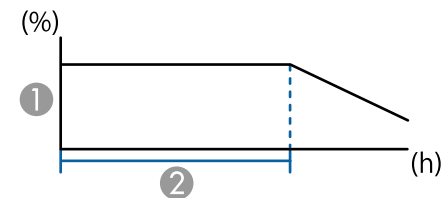

- ① Maintain brightness level
- ② Time the projector can maintain constant brightness (approximate)

## Light Source Operation Time

The light source operation time varies depending on the **Brightness Level** setting and whether **Maintain Brightness** is on or off.

Maintain Brightness Level setting	Hours
85%	6,000 hours
80%	10,000 hours
75%	14,000 hours
70%	19,000 hours

The volume buttons control the projector's internal speaker system.

You can also control the volume of any external speakers you connected to the projector.

You must adjust the volume separately for each connected input source.

- 1** Turn on the projector and start a presentation.
- 2** To lower or raise the volume, press the [Volume] buttons on the remote control as shown.

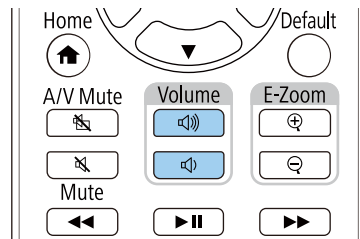

A volume gauge appears on the screen.

- 3** To set the volume to a specific level for an input source, select **Volume** in the projector's **Signal I/O** menu.

## **Caution**

Do not start a presentation at a high volume setting. Sudden loud noises may cause hearing loss.

Always lower the volume before powering off, so that you can power on and then gradually increase the volume.

# Adjusting Projector Features

Follow the instructions in these sections to use your projector's adjustment features.

## ► Related Links

- "HDMI Link Features" [p.94](#)
- "Projecting Two Images Simultaneously" [p.96](#)
- "Projecting a PC Free Presentation" [p.99](#)
- "Projecting in Content Playback Mode" [p.104](#)
- "Shutting Off the Image and Sound Temporarily" [p.110](#)
- "Stopping Video Action Temporarily" [p.111](#)
- "Turning Off the Sound Temporarily (Mute)" [p.112](#)
- "Zooming Images (E-Zoom)" [p.113](#)
- "Saving a User's Logo Image" [p.114](#)
- "Saving Settings to Memory and Using Saved Settings" [p.116](#)
- "Using Advanced Image Adjustment Features" [p.117](#)
- "Multi-Projection Features" [p.120](#)
- "External Camera Usage" [p.131](#)
- "Projector Security Features" [p.133](#)

When an audio/video source that meets the HDMI CEC standard is connected to the projector's HDMI port, you can use the projector's remote control to control certain features of the linked device.

Example: Projector, audio/video system, and multi-media players connection

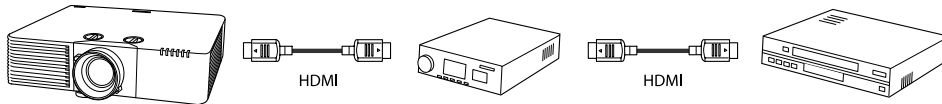

- As long as the connected device meets the HDMI CEC standard, you can use the HDMI Link features even if the audio/video system in-between does not meet the HDMI CEC standard.
- Up to 3 multi-media players that meet the HDMI CEC standard can be connected at the same time.

### ► Related Links

- "Operating the Connected Devices Using the HDMI Link Features" [p.94](#)

## Operating the Connected Devices Using the HDMI Link Features

You can select the connected device that is available for HDMI Link and control the selected device using the HDMI Link features.



- When you use the HDMI Link features, set the **HDMI Link** setting to **On** in the projector's **Signal I/O** menu.
- You must also configure the connected device. See the documentation supplied with the device for more information.
- Some connected devices or functions of those devices may not operate properly even if they meet the HDMI CEC standard. See the documentation supplied with the device for more information.
- Use a cable that supports the HDMI standard.

**1** Press the [Menu] button on the control panel or remote control.

**2** Select **Signal I/O** and press [Enter].

**3** Select **HDMI Link** and press [Enter].  
On the screen displayed, make sure that **HDMI Link** is set to **On**.

**4** Select **Device Connections** and press [Enter].

**5** Select the device you want to control and project the image from, and press [Enter].



- A linked device is indicated by a blue mark.
- The device name is left blank if it cannot be acquired.

**6** Press [Esc] to select the HDMI Link options as necessary.

- **Audio Out Device:** Select the device for audio output.



- Select **Projector** to output audio from the projector itself.
- Select **AV System** to output audio from an AV amplifier that is connected using an HDMI cable.

- **Power On Link** lets you control what happens when you turn on the projector or linked device.



- Select **PJ -> Device** or **Bidirectional** to turn the linked device on when the projector is turned on.
- Select **Device -> PJ** or **Bidirectional** to turn the projector on when the linked device is turned on.

- **Power Off Link** lets you control whether linked devices are turned off when the projector is turned off.



- **Power Off Link** only works when the connected device's CEC power link function is enabled.
- Note that depending on the status of the connected device (for example, if it is recording), the device may not be turned off.

**7** Press [Esc] to exit the menus.

You can use the projector's remote control to control the linked device, such as playback, stop, fast forward, and rewind.

You can use the split screen feature to simultaneously project two images from different image sources. You can control the split screen feature using the remote control or the projector menus.

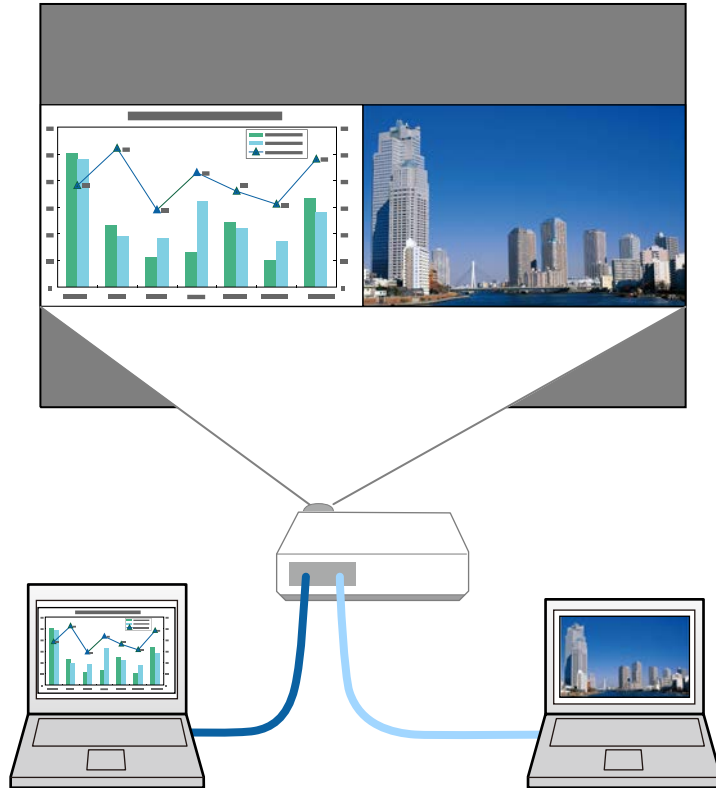

- 1 Turn on the projector and display an image
- 2 Press the [Home] button.
- 3 Select **Split Screen**.

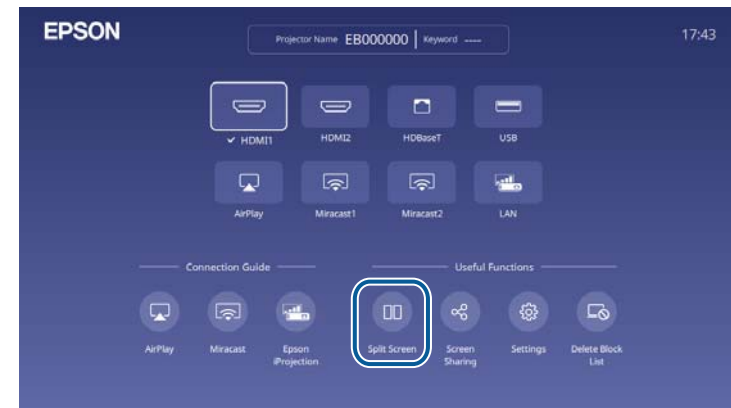

- 4 Press the [Menu] button.



- While using the split screen feature, other projector features may not be available and some settings may be automatically applied to both images.
- You cannot perform split screen projection when the **Content Playback** setting is set to **On** in the projector's **Operation** menu.
- You may not be able to perform split screen projection when you use the **Scale** feature or the **Edge Blending** feature in the projector's **Multi-Projection** menu.



**5** When splitting screen into halves, do the following as necessary:

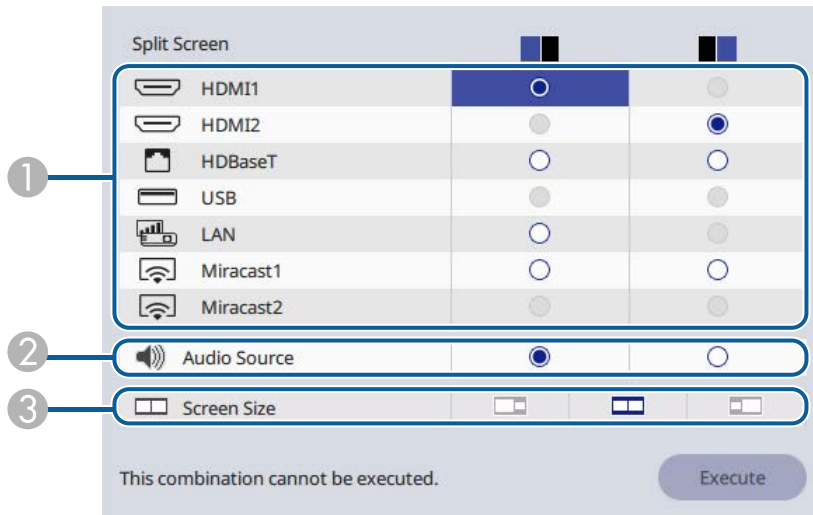

1 Select the input source.



You can only select input sources that can be combined.

2 Select the screen from which you want to hear audio.

3 Select the screen size.

**6** Select **Execute** and press [Enter].

**7** To exit the split screen feature, press [Esc].

**▶▶ Related Links**

- "Input Sources for Split Screen Projection" [p.97](#)
- "Split Screen Projection Restrictions" [p.98](#)

## Input Sources for Split Screen Projection

The combinations of input sources that can be projected on a split screen are listed below.

**EB-L890E/EB-L895E/EB-L790SE/EB-L795SE/EB-L690E/EB-L890U/EB-L895U/EB-L790U/EB-L790SU/EB-L690U/EB-L690SU/EB-L695SU**

Left Screen	Right Screen					
	HDMI1	HDMI2	HDBaseT	USB	LAN	Miracast1 /2
HDMI1	-	✓	✓	✓	-	-
HDMI2	✓	-	-	✓	✓	✓
HDBaseT	✓	-	-	✓	✓	✓
USB	✓	✓	✓	-	-	✓
LAN	-	✓	✓	-	-	-
Miracast1 /2	-	✓	✓	✓	-	-

**EB-L690SE/EB-L695SE**

Left Screen	Right Screen				
	HDMI1	HDMI2	HDBaseT	USB	LAN
HDMI1	-	✓	✓	✓	✓
HDMI2	✓	-	-	✓	✓
HDBaseT	✓	-	-	✓	✓
USB	✓	✓	✓	-	-
LAN	✓	✓	✓	-	-

## Split Screen Projection Restrictions

### Operating restrictions

The following operations cannot be performed during split screen projection.

- Setting the projector's menu
- E-Zoom
- Switching the aspect mode (the aspect mode is set to **Auto**)
- Operations using the [Customize] button on the remote control, other than displaying the network information on the projected surface.
- Applying the **Dynamic Contrast** setting
- Displaying the network information on the projected surface by a method other than pressing the [Customize] button.
- Displaying the **Miracast** information bar

### Image restrictions

- Even if you set **No-signal Screen** to **Logo** in the projector's **Display** menu, the blue screen appears when no image signal is being input.
- When you create a single unified image projected from multiple projectors and use the split screen feature, the second projector does not detect an image signal.

### ▶▶ Related Links

- "Image Aspect Ratio" [p.80](#)
- "Zooming Images (E-Zoom)" [p.113](#)
- "Turning On Automatic Luminance Adjustment" [p.83](#)
- "Adjusting the Menu Settings" [p.190](#)

You can use your projector's PC Free feature whenever you connect a USB device that contains compatible presentation files. This lets you quickly and easily display a presentation and control it using the projector's remote control.

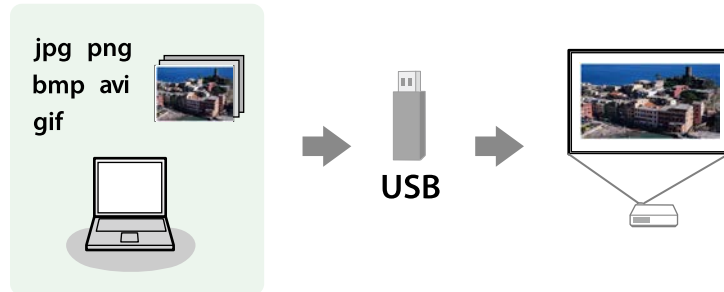

► **Related Links**

- "Supported PC Free File Types" [p.99](#)
- "Precautions on PC Free Projection" [p.99](#)
- "Starting a PC Free Slide Show" [p.100](#)
- "Starting a PC Free Movie Presentation" [p.101](#)
- "PC Free Display Options" [p.102](#)

## Supported PC Free File Types

You can project these types of files using the projector's PC Free feature.



- For best results, place your files on media that is formatted in FAT16/32.
- If you have trouble projecting from media formatted for non-Windows file systems, try formatting the media for Windows instead.

File contents	File type (extension)	Details
Image	.jpg	Make sure the file is not: <ul style="list-style-type: none"> <li>• CMYK format</li> <li>• Progressive format</li> <li>• Highly compressed</li> <li>• Above 8,192 × 8,192 resolution</li> </ul>
	.bmp	Make sure the file is not: <ul style="list-style-type: none"> <li>• Above 1,280 × 800 resolution</li> </ul>
	.gif	Make sure the file is not: <ul style="list-style-type: none"> <li>• Above 1,280 × 800 resolution</li> <li>• Animated</li> <li>• Interlaced</li> </ul>
	.png	Make sure the file is not: <ul style="list-style-type: none"> <li>• Above 1,920 × 1200 resolution</li> <li>• Interlaced</li> </ul>
Movie	.avi	<ul style="list-style-type: none"> <li>• Version: AVI 1.0 only</li> <li>• Resolution: 1,280 × 720 or less</li> <li>• Size: 2 GB or less</li> <li>• Movie Codec: Motion JPEG</li> <li>• Frame Rate: up to 30 fps</li> <li>• Audio Codec: LPCM or IMA ADPCM</li> <li>• Audio Sampling Rate: 11.025 kHz, 22.05 kHz, 44.1 kHz, 16 kHz, 24 kHz, 32 kHz, or 48 kHz</li> </ul>

## Precautions on PC Free Projection

Note the following precautions when using PC Free features.

- You cannot use a USB key for PC Free features.
- Do not disconnect the USB storage device while it is being accessed; otherwise, PC Free may not operate correctly.
- You may not be able to use the security features on certain USB storage devices with PC Free features.
- When connecting a USB device that includes an AC adapter, connect the AC adapter to an electrical outlet when you use the device with your projector.
- Some commercially available USB card readers may not be compatible with the projector.
- The projector can recognize up to 5 cards inserted into the connected card reader at one time.
- You can use the following functions while projecting in PC Free.
  - Freeze
  - A/V Mute
  - E-Zoom

## ► Related Links

- "Stopping Video Action Temporarily" [p.111](#)
- "Shutting Off the Image and Sound Temporarily" [p.110](#)
- "Zooming Images (E-Zoom)" [p.113](#)

## Starting a PC Free Slide Show

After connecting a USB device to the projector, you can switch to the USB input source and start your slide show.



You can change the PC Free operation options or add special effects by highlighting **Option** at the bottom of the screen and pressing [Enter].

- 1** Press the [USB] button on the remote control.  
The PC Free file list screen is displayed.



- If the Select Drive screen is displayed, press the arrow buttons to select the drive and press [Enter].
- To display images on the other USB drive, highlight **Select Drive** at the top of the file list screen and press [Enter].

- 2** Do one of the following to locate your files:
  - If you need to display files inside a subfolder on your device, press the arrow buttons to highlight the folder and press [Enter].
  - To move back up a folder level on your device, highlight **Back to Top** and press [Enter].
  - To view additional files in a folder, highlight **Next Page** or **Previous Page** and press [Enter].

- 3** Do one of the following:
- To display an individual image, press the arrow buttons to highlight the image and press [Enter]. (Press the [Esc] button to return to the file list screen.)
  - To display a slide show of all the images in a folder, press the arrow buttons to highlight the **Slideshow** option at the bottom of the screen and press [Enter].



- You can change the image switching time by highlighting **Option** at the bottom of the screen and pressing [Enter].
- If any file names are longer than the display area or include unsupported symbols, the file names may be shortened or changed only on the screen display.

- 4** While projecting, use the following commands to control the display:
- To rotate a displayed image, press the up or down arrow button.

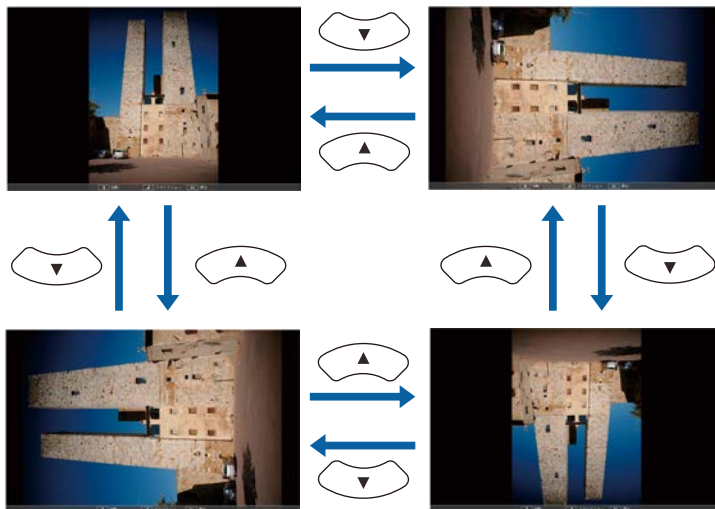

- To move to the next or previous image, press the left or right arrow button.

- 5** To stop the display, follow the on-screen instructions or press the [Esc] button.  
You return to the file list screen.

- 6** Turn off the USB device, if necessary, and then disconnect the device from the projector.

## ▶▶ Related Links

- "Connecting to a USB Device" [p.37](#)
- "PC Free Display Options" [p.102](#)

## Starting a PC Free Movie Presentation

After connecting a USB device to the projector, you can switch to the USB input source and start your movie.



You can change the PC Free operation options by highlighting **Option** at the bottom of the screen and pressing [Enter].

- 1** Press the [USB] button on the remote control.  
The PC Free file list screen is displayed.



- If the Select Drive screen is displayed, press the arrow buttons to select the drive and press [Enter].
- To display movie files on the other USB drive, highlight **Select Drive** at the top of the file list screen and press [Enter].

## 2 Do one of the following to locate your files:

- If you need to display files inside a subfolder on your device, press the arrow buttons to highlight the folder and press [Enter].
- To move back up a folder level on your device, highlight **Back to Top** and press [Enter].
- To view additional files in a folder, highlight **Next Page** or **Previous Page** and press [Enter].

## 3 To play back a movie, press the arrow buttons to highlight the file and press [Enter].



- If any file names are longer than the display area or include unsupported symbols, the file names may be shortened or changed only on the screen display.
- If you want to play back all the movies in a folder in sequence, select the **Slideshow** option at the bottom of the screen.

## 4 To stop movie playback, press the [Esc] button, highlight **Exit**, and press [Enter].

You return to the file list screen.

## 5 Turn off the USB device, if necessary, and then disconnect the device from the projector.

### ► Related Links

- "Connecting to a USB Device" [p.37](#)
- "PC Free Display Options" [p.102](#)

---

## PC Free Display Options

You can select these display options when using PC Free. To access this screen, highlight **Option** at the bottom of the PC Free file list screen and press [Enter].

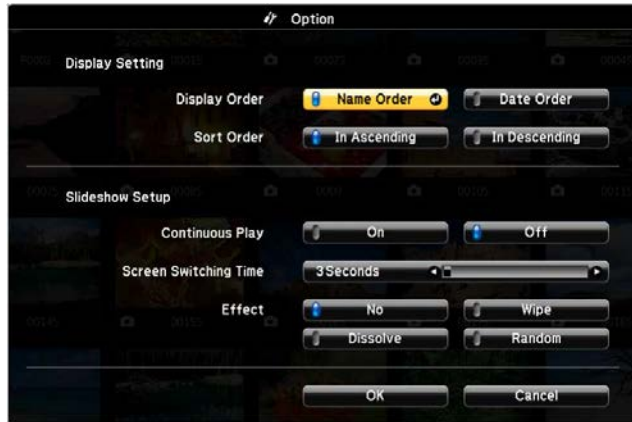

Setting	Options	Description
	Random	Transitions between images using a random variety of effects

Setting	Options	Description
Display Order	Name Order	Displays files in name order
	Date Order	Displays files in date order
Sort Order	In Ascending	Sorts files in first-to-last order
	In Descending	Sorts files in last-to-first order
Continuous Play	On	Displays a slide show continuously
	Off	Displays a slide show once
Screen Switching Time	No	Does not display the next file automatically
	1 Second to 60 Seconds	Displays files for the selected time and switches to the next file automatically; high resolution images may switch at a slightly slower rate
Effect	No	No effect
	Wipe	Transitions between images using a wipe effect
	Dissolve	Transitions between images using a dissolve effect

Your projector's Content Playback feature allows you to project your digital signage content. You can easily project playlists that contain images and movies saved on an external storage device. You can also add color and shape effects to your projected image.



**► Related Links**

- "Supported Content Playback Mode File Types" [p.104](#)
- "Switching to Content Playback Mode" [p.104](#)
- "Projecting Your Playlists" [p.105](#)
- "Adding Effects to Your Projected Image" [p.108](#)
- "Content Playback Mode Restrictions" [p.109](#)

File contents	File type (extension)	Details
Image	.jpg	Make sure the file is not: <ul style="list-style-type: none"> <li>• Progressive format</li> <li>• Highly compressed</li> <li>• Above 8,192 × 8,192 resolution</li> </ul>
	.bmp	Make sure the file is not: <ul style="list-style-type: none"> <li>• Above 1,280 × 800 resolution</li> </ul>
	.gif	Make sure the file is not: <ul style="list-style-type: none"> <li>• Above 1,280 × 800 resolution</li> <li>• Animated</li> <li>• Interlaced</li> </ul>
	.png	Make sure the file is not: <ul style="list-style-type: none"> <li>• Above 1,280 × 800 resolution</li> <li>• Interlaced</li> </ul>
Movie	.avi (Motion JPEG)	<ul style="list-style-type: none"> <li>• Version: AVI 1.0 only</li> <li>• Resolution: 1,280 × 720 or less</li> <li>• Size: 2 GB or less</li> <li>• Movie Codec: Motion JPEG</li> <li>• Frame Rate: up to 30 fps</li> <li>• Audio Codec: LPCM or IMA ADPCM</li> <li>• Audio Sampling Rate: 11.025 kHz, 22.05 kHz, 44.1 kHz, 16 kHz, 24 kHz, 32 kHz, or 48 kHz</li> </ul>

## Supported Content Playback Mode File Types

You can project these types of files using the projector's Content Playback feature.

## Switching to Content Playback Mode

Before you project your playlists, you need to switch to Content Playback mode.

- 1** Turn on the projector.



- 2** Press the [Menu] button, select the **Operation** menu, and then press [Enter].

Image	Standby Mode	Normal
Signal I/O	Standby Audio Output	On <input type="checkbox"/>
Installation	Auto Power On	Off <input type="checkbox"/>
Multi-Projection	Quick Startup	Off <input type="checkbox"/>
Display	HDBaseT	
Operation	Light Source Brightness C...	
Management	Startup Source	Last Source
Network	Sleep Mode	On <input checked="" type="checkbox"/>
Info	Sleep Mode Timer	10 min.
Memory	A/V Mute Settings	
ECO	Operation Settings	
Initial/All Settings	Content Playback	
	Reset Operation Settings	

- 3** Select the **Content Playback** setting and set it to **On**.  
You see a confirmation prompt.
- 4** Turn off the projector, then turn it on again to enable Content Playback mode.

## Projecting Your Playlists

You can project playlists that contain images and movies in Content Playback mode.



- 1** Create your playlists and export them to a USB flash drive using one of the following methods:
- The Epson Projector Content Manager software lets you create playlists and save them on an external storage device. You can also add color and shape effects to your projected image, and schedule playlists.  
You can download and install Epson Projector Content Manager from the following Web site.  
[epson.sn](http://epson.sn)  
See the *Epson Projector Content Manager Operation Guide* for instructions.
  - Epson Web Control allows you to create playlists using a Web browser and save them to an external storage device connected to a projector on a network. You can also add color and shape effects to your projected image.
  - The Epson Creative Projection app lets you create content on iOS devices. You can also transfer content to the projector wirelessly.  
You can download Epson Creative Projection from the App Store.  
Any fees incurred when communicating with the App Store are the responsibility of the customer.

- 2** In Content Playback mode, connect the USB flash drive into the projector's USB-A port.

- 3 Press the [USB] button on the remote control.

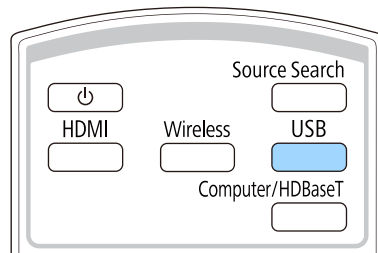

The playlist that was played last is projected. If there is a timetable assigned, the playlist will play back according to the schedule in the timetable.



- You can also press the numeric buttons to project your favorite playlist. You can set a remote control shortcut key using the software you used to create the playlists.
- To select the target playlist from the list, select **USB Viewer** in the projector's **Operation** menu, and use the arrow buttons.

## ► Related Links

- "Creating Playlists Using Epson Web Control" [p.106](#)

## Creating Playlists Using Epson Web Control

In Content Playback mode, you can create playlists using a Web browser and save them to a USB flash drive connected to a projector on a network.

### Attention

Do not remove the USB flash drive from the projector or disconnect the projector's power cord while creating playlists. Data saved on the USB flash drive may be damaged.

- 1 Make sure the projector is operating in Content Playback mode.
- 2 Make sure your computer or device is connected to the same network as the projector.
- 3 Make sure a USB flash drive is connected to the projector's USB-A port.
- 4 Start your Web browser on your computer or device.
- 5 Go to the Epson Web Control screen by entering the projector's IP address into the browser's address box. When entering an IPv6 address, wrap the address with [ and ].
- 6 Select **USB Memory Device**.

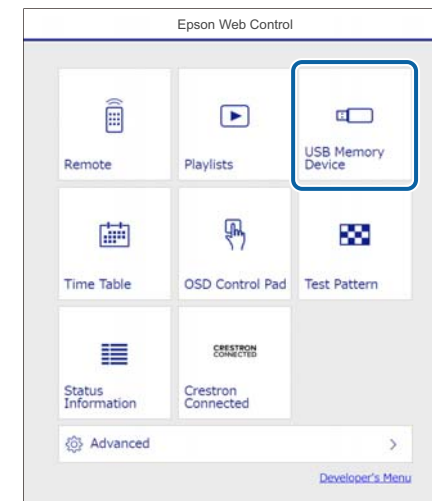

## 7 Select Upload New Data.

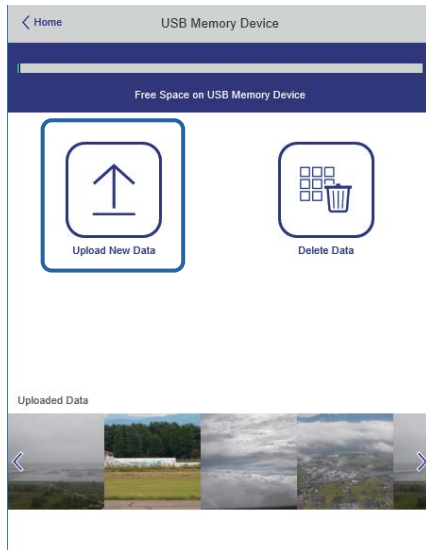

## 8 Select the images or movies you want to add to the playlist.



You can upload .avi, .jpeg (.jpg), .png, .bmp, or .gif files. If you want to add .mp4 or .mov files to the playlist, use the Epson Projector Content Manager software or the Epson Creative Projection app.

The selected files are copied to the connected USB flash drive.

## 9 Do one of the following:

- To add them to the existing playlist, select **Add to Playlist** and select the playlist you want to add them to.
- To create a new playlist and add them to it, select **Create New Playlist**.

## 10 Edit the playlist.

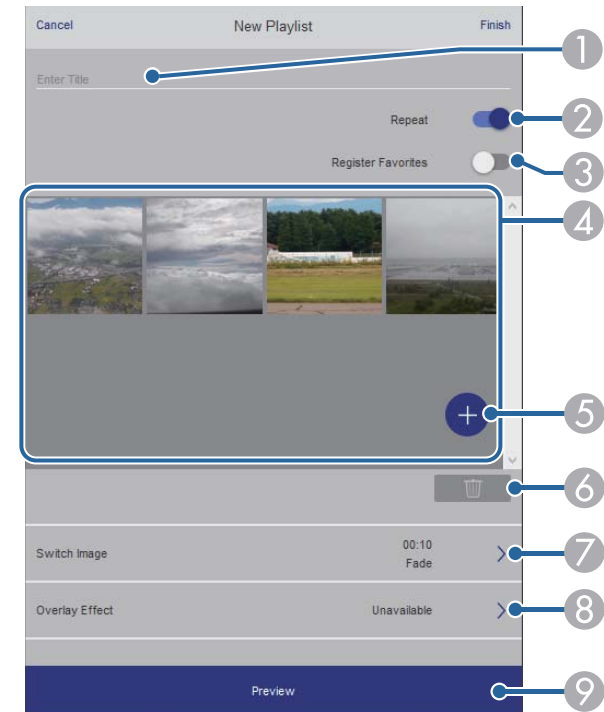

- 1 Edits the playlist name.
- 2 Selects whether to enable repeat playback or not.
- 3 Registers the playlist to your favorites.  
When a playlist has been registered as a favorite, you can start playback quickly using the **Remote** screen or the remote control.
- 4 Displays the images or movies you have added to the playlist. The playlist plays the images or movies in order.
- 5 Adds images or movies to the playlist.
- 6 Deletes images or movies from the playlist.

- 7 Opens the **Switch Image** screen.  
You can specify the time interval to switch to the next image file. You can also select a transition effect.
- 8 Opens the **Effects** screen.  
You can add predefined color and shape effect filters to a playlist. You can also create a customized effect.
- 9 Previews the playlist.

**11** When you have finished editing the playlist, select **Finish**.



- You can play the playlist from the **Remote** or **Playlist** screen.
- When you want to specify when the playlist starts and finishes, schedule the playlist using the Epson Projector Content Manager software.

## Adding Effects to Your Projected Image

You can add color and shape effects to the projected image in Content Playback mode.

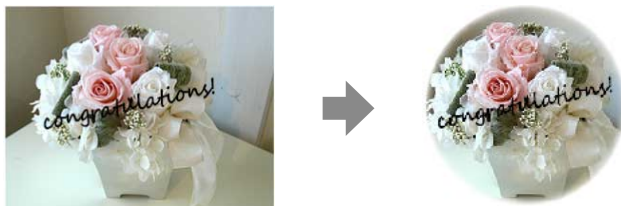

- To use the effect functions, make sure you perform **Refresh Mode** regularly.  
  - ☛ **Management > Refresh Mode**
- This feature is not available when using the **Edge Blending** feature.

**1** In Content Playback mode, press the [Menu] button, select the **Operation** menu, and then press [Enter].

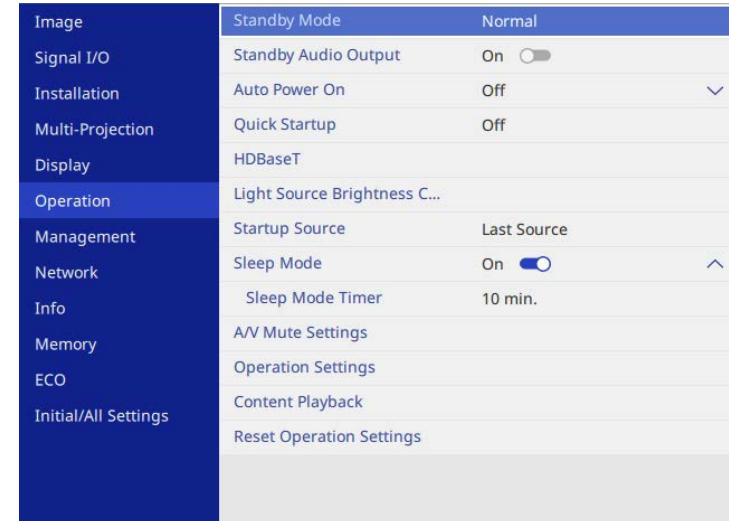

**2** Select **Content Playback** and press [Enter].

**3** Select **Overlay Effect** and press [Enter].

**4** Select **On** as the **Overlay Effect** setting and press [Enter].

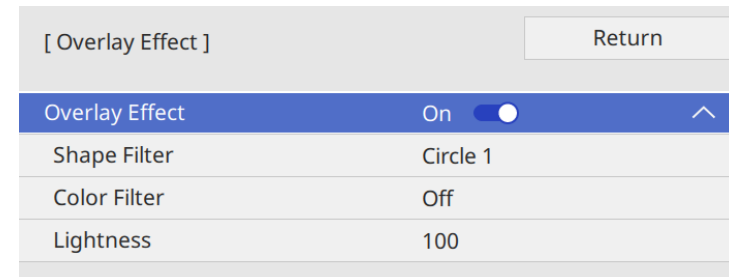

**5** Select **Shape Filter** and press [Enter].

**6** Adjust each of the following options as necessary:

- **Shape** to select the shape effect you want from circles, rectangles, or customized shapes.



You can add your images as customized shapes using the Epson Projector Content Manager software. See the *Epson Projector Content Manager Operation Guide* for details.

- **Filter Effect** to select whether to mask inside or outside of the selected shape.
- **Size** to set the shape size.
- **Position** to set the shape position.



When you use a customized shape, you cannot change the **Size** and **Position** settings.

**7** Select **Color Filter** and press [Enter].

**8** Adjust each of the following options as necessary:

- **Color Filter** to select the color.
- **Custom** to set a customized color by adjusting **Red**, **Green**, and **Blue** individually.

**9** Select **Lightness** to set the brightness level.

**10** When you are finished, press [Menu] to exit the menus.

#### ▶▶ Related Links

- "Projector Feature Settings - Operation Menu" [p.204](#)

## Content Playback Mode Restrictions

### Operating restrictions

The following operations cannot be performed in Content Playback mode.

- Changing the **Color Temp.** setting in the **Image** menu (when **Warm White** or **Cool White** is selected as **Color Filter**)
- Split Screen
- Log Save Destination
- Blanking
- Changing the **Screen Type** setting in the **Installation** menu
- Changing the **No-signal Screen** setting in the **Display** menu
- Detecting the input signal automatically
- Changing **Remote Password** in the **Network Settings** menu
- Basic Control
- PC Free
- USB Document camera
- Screen delivery function using the Epson iProjection software

### ▶▶ Related Links

- "Image Quality Settings - Image Menu" [p.193](#)
- "Network Menu - Network Settings Menu" [p.212](#)
- "Projecting Two Images Simultaneously" [p.96](#)
- "Setting the Screen Type" [p.56](#)
- "Projecting a PC Free Presentation" [p.99](#)

You can temporarily turn off the projected image and sound.

This is effective when you want to redirect your audience's attention during a presentation.

Any sound or video action continues to run, however, so you cannot resume projection at the point that you stopped it.

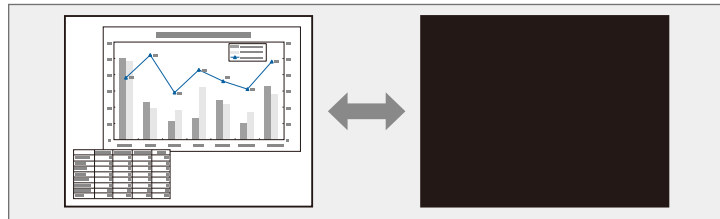

## ► Related Links

- "Projector Feature Settings - Operation Menu" [p.204](#)

- 1 Press the [A/V Mute] button on the control panel or remote control.

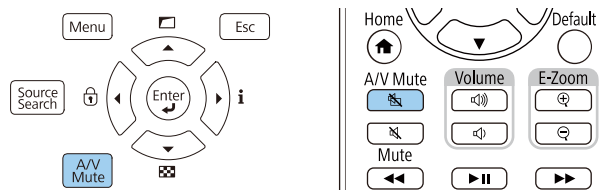

The light source turns off and the projected image and sound are interrupted.

- 2 To turn the image and sound back on, press [A/V Mute] again.



- The projector's power automatically turns off 30 minutes after A/V Mute is enabled. You can disable this feature.
  - ☛ **Operation > A/V Mute Settings > A/V Mute Timer**
- If you selected A/V Mute as the **Button to Release A/V Mute** setting in the **Operation** menu, you can still control the projector while A/V Mute is enabled.
  - ☛ **Operation > A/V Mute Settings > Button to Release A/V Mute**

You can temporarily stop the action in a video or computer presentation and keep the current image on the screen. Any sound or video action continues to run, however, so you cannot resume projection at the point that you stopped it.

- 1 Press the [Freeze] button on the remote control to stop the video action.

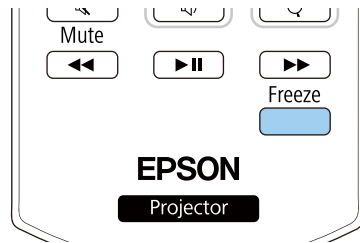

- 2 To restart the video action in progress, press [Freeze] again.



When you press the [Freeze] button on the remote control, a screen is displayed asking if you want to capture the image currently being projected and use it as a test pattern. (This screen is not displayed when 4K Enhancement is set to On.)

If you press the [Enter] button and capture the projected image as a test pattern during Freeze, you can use the captured image as one of the test patterns. While projecting the captured image, you can perform adjustments such as lens shift, focus, and geometry correction.

The captured test pattern is available until you turn off the projector.

You can temporarily turn off the sound.

- 1** Press the [Mute] button on the remote control.

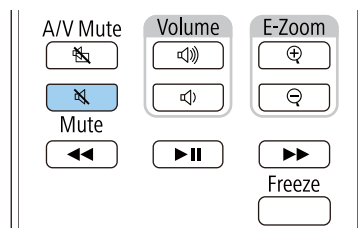

- 2** To turn the sound back on, press [Mute] again.



You can draw attention to parts of a presentation by zooming into a portion of the image and enlarging it on the screen.

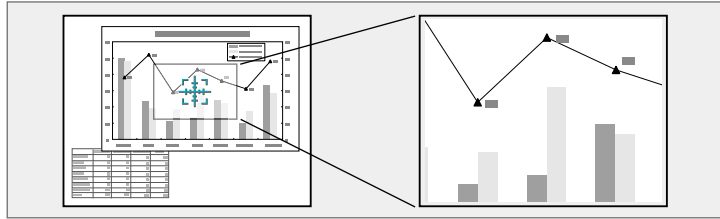

This feature is unavailable if the **Scale** setting in the projector's **Image** menu is enabled.

**1** Press the [E-Zoom] + button on the remote control.

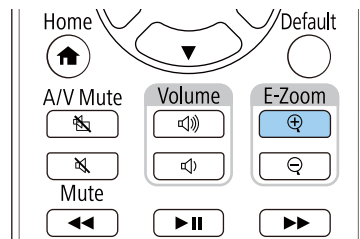

You see a crosshair on the screen indicating the center of the zoom area.

**2** Use the following buttons on the remote control to adjust the zoomed image:

- Use the arrow buttons to position the crosshair in the image area you want to zoom into. To move the crosshair diagonally, press any pair of adjacent arrow buttons at the same time.
- Press the [E-Zoom] + button repeatedly to zoom into the image area. Press and hold the [E-Zoom] + button to zoom in more quickly.
- To pan around the zoomed image area, use the arrow buttons.

- To zoom out of the image, press the [E-Zoom] – button.

- To return to the original image size, press [Esc].

The enlarged image is projected and the enlargement ratio is displayed on the screen.

You can enlarge the selected area to between one to four times in 25 incremental steps.

When projecting images from an Epson document camera using a USB connection, you can enlarge the selected area from one to eight times its size in 57 incremental steps.

You can save an image on the projector and display it whenever the projector turns on. You can also display the image when the projector is not receiving an input signal. This image is called the user's logo screen.

You can select a photo, graphic, or company logo as the user's logo, which is useful in identifying the projector's owner to help deter theft. You can prevent changes to the user's logo by setting up password protection.



- If you turned on **Menu Protection** for the **User's Logo** setting, set it to **Off** before performing the steps here to save the user's logo.
- When you copy the menu settings from one projector to another using the batch setup feature, user's logo is also copied. Do not register the information that you do not want to share between multiple projectors as a user's logo.
- You cannot save content that is protected by HDCP.
- When **Content Playback** is set to **On**, you can display the user's logo only when the projector starts up.
- The user's logo image is not 4K enhanced image quality.
- This function is unavailable if the input source is AirPlay, LAN or Miracast. (EB-L890E/EB-L895E/EB-L790SE/EB-L795SE/EB-L690E/EB-L890U/EB-L895U/EB-L790U/EB-L790SU/EB-L690U/EB-L690SU/EB-L695SU)

**1** Display the image you want to project as the user's logo.

**2** Press the [Menu] button, select the **Management** menu, and press [Enter].

Image	Customize Button	Not Set
Signal I/O	User's Logo	
Installation	Control Panel Lock	Off
Multi-Projection	Color Uniformity	
Display	Refresh Mode	
Operation	Light Source Calibration	
Management	Color Calibration	
Network	Date & Time	
Info	Schedule Settings	
Memory	NFC Settings	
ECO	Language	English
Initial/All Settings	Reset Management Settings	

**3** Select **User's Logo > Start Setting** and press [Enter].

You see a prompt asking if you want to use the displayed image as a user's logo.



Adjustments such as **Geometry Correction**, **E-Zoom**, **Aspect**, **Scale**, or **Screen Type** are temporarily canceled when you select **User's Logo**.

**4** Select **Yes** and press [Enter].

**5** Check the displayed image, and then select **Yes** to save it as the user's logo. The user's logo is overwritten and a completion message is displayed.

**6** Press [Esc] to exit the message screen.

**7** Select the **Display** menu and press [Enter].

Image	No-signal Screen	Blue
Signal I/O	Startup Screen	On <input checked="" type="checkbox"/>
Installation	Standby Confirmation	On <input checked="" type="checkbox"/>
Multi-Projection	Home Screen Auto Disp.	On <input checked="" type="checkbox"/>
<b>Display</b>	Messages	On <input checked="" type="checkbox"/>
Operation	Message Position	Top Right
Management	Menu Rotation	Off
Network	Menu Color	White
Info	Menu Position	Center
Memory	Air Filter Notice	On <input checked="" type="checkbox"/>
ECO	Split Screen Setting	
Initial/All Settings	Reset Display Settings	

**8** Select when you want to display the User's Logo screen:

- To display it whenever there is no input signal, select **No-signal Screen** and set it to **Logo**.
- To display it whenever you turn the projector on, select **Startup Screen** and set it to **On**.



To prevent changes to the **User's Logo** settings, turn on **Menu Protection** for the **User's Logo** setting and set the password.

## ▶ Related Links

- "Selecting Password Security Types" [p.134](#)

You can save customized settings and then select the saved settings whenever you want to use them.

- 1 Turn on the projector and display an image.
- 2 Press the [Menu] button, select the **Memory** menu, and press [Enter].

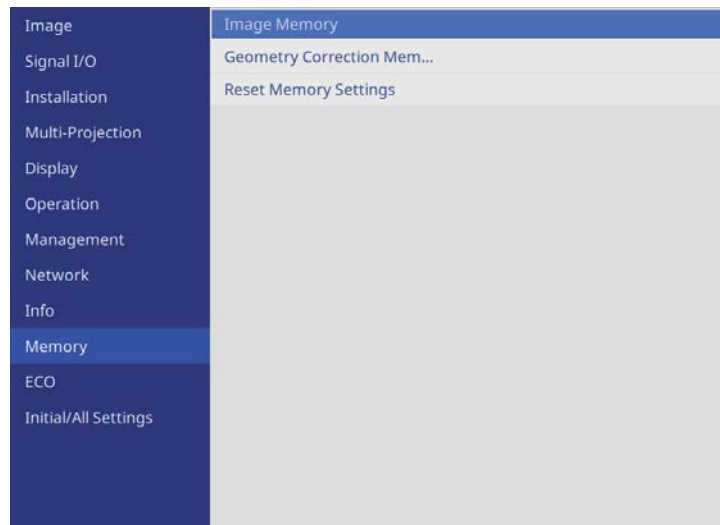

- 3 Select **Image Memory** then press [Enter].
- 4 Select one of the following options:
  - **Save Memory** lets you save your current settings to memory (10 memories with different names are available).



- You can save the following settings:
  - **Image** menu settings for each color mode
  - **Video Range** in the **Signal I/O** menu
  - **Light Source Mode** and **Brightness Level** in the **Operation** menu
    - ☛ **Operation > Light Source Brightness Control > Light Source Mode**
    - ☛ **Operation > Light Source Brightness Control > Brightness Level**
  - **Color Matching** in the **Multi-Projection** menu
    - ☛ **Multi-Projection > Screen Matching > Color Matching**
- A memory name that has already been used is indicated by a blue mark. Saving over a previously saved memory overwrites the settings with your current settings.

- **Load Memory** lets you overwrite your current settings with saved settings.
- **Rename Memory** lets you rename a saved memory.
- **Erase Memory** lets you erase the selected memory settings.

- 5 Press [Menu] or [Esc] to exit the menus.



- The saved Color Mode is displayed on the right of the memory name.
- To delete all saved memories, select **Reset Memory Settings**.

## » Related Links

- "Image Quality Settings - Image Menu" [p.193](#)
- "Input Signal Settings - Signal I/O Menu" [p.196](#)
- "Projector Feature Settings - Operation Menu" [p.204](#)
- "Multiple Projector Operation Settings - Multi-Projection Menu" [p.200](#)

Follow the instructions in these sections to use your projector's advanced image adjustments.

### ▶ Related Links

- "Adjusting the Color Tone (Color Uniformity)" [p.117](#)
- "Running Light Source Calibration" [p.118](#)

## Adjusting the Color Tone (Color Uniformity)

You can use the Color Uniformity feature to manually adjust the color tone balance in the projected image.



The color tone may not be uniform even after adjusting the color uniformity.

**1** Press the [Menu] button, select the **Multi-Projection** menu, and press [Enter].

Image	Projector ID	Off
Signal I/O	Batch Setup	
Installation	Group Tiling	
Multi-Projection	Geometry Correction	H/V-Keystone
Display	Edge Blending	
Operation	Black Level	
Management	Scale	
Network	Screen Matching	
Info	Color Uniformity	
Memory	Light Source Mode	Normal
ECO	Color Matching	
Initial/All Settings	RGBCMY	
	Camera Correction Assist	
	Reset Multi-Projection Sett...	

**2** Select **Color Uniformity** and press [Enter].

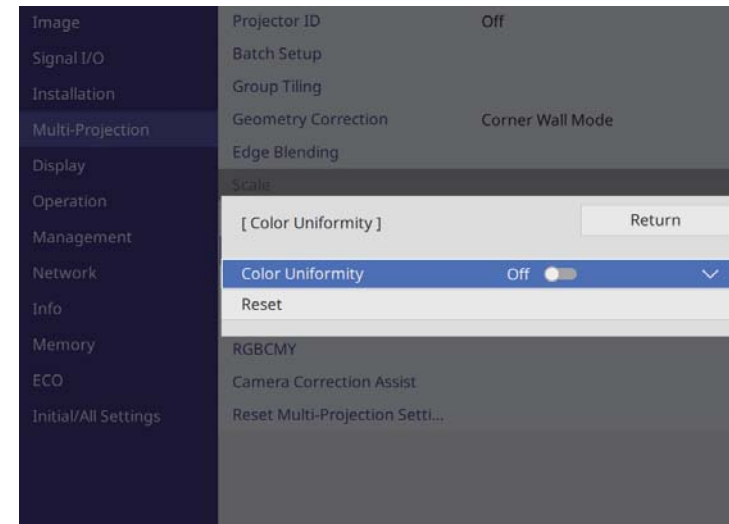

**3** Select **Color Uniformity** again and set it to **On**.

**4** Select **Adjustment Level** and press [Enter].

**5** Select the first adjustment level you want to adjust and press [Esc].



There are eight adjustment levels, from white to gray to black. You can adjust each level individually.

**6** Select **Start Adjustments** and press [Enter].

- 7** Select the area of the image you want to adjust and press [Enter].

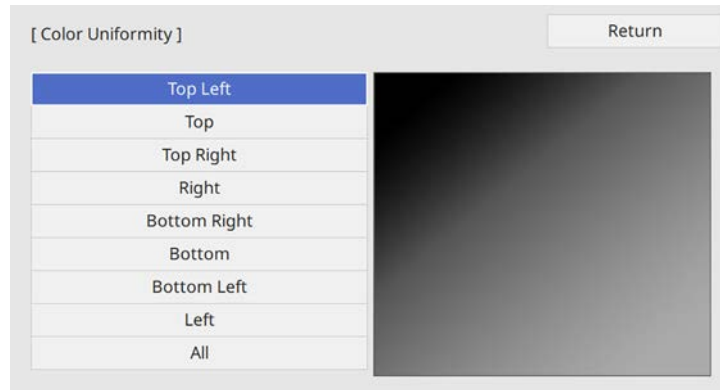

Adjust each area individually, then select **All** and adjust the entire screen.

- 8** Select **Red**, **Green**, or **Blue** and adjust the color tone, if necessary.

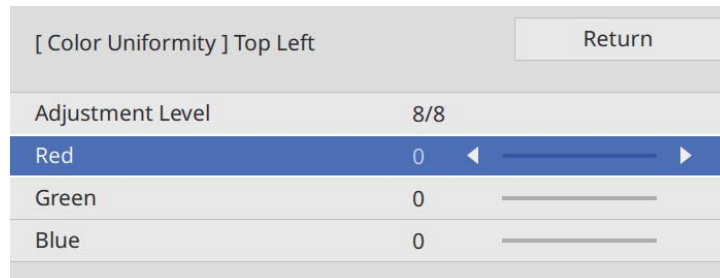

The adjustment screen changes each time you press [Enter].

- 9** Press [Esc] to return to the area selection screen.

- 10** Repeat the color adjustments to each area.

- 11** Return to step 4 and repeat all steps to adjust other levels.

- 12** When you are finished, press [Menu] to exit.

---

## Running Light Source Calibration

Light source calibration automatically adjusts any difference between the white balance and the brightness level of the light source. You should perform light source calibration every 100 hours of projector usage. You can also schedule automatic calibration or run the light source calibration manually using the menus.

Automatic light source calibration may not start in the following conditions:

- Within 30 minutes of turning on the projector.
- When using direct shutdown.
- When you have used the projector continuously for over 24 hours.
- When the projector brightness is automatically dimmed due to high temperatures.

- 1** Turn on the projector.

**2** Press the [Menu] button, select the **Management** menu, and press [Enter].

Image	Customize Button	Not Set
Signal I/O	User's Logo	
Installation	Control Panel Lock	Off
Multi-Projection	Color Uniformity	
Display	Refresh Mode	
Operation	Light Source Calibration	
<b>Management</b>	Color Calibration	
Network	Date & Time	
Info	Schedule Settings	
Memory	NFC Settings	
ECO	Language 	English
Initial/All Settings	Reset Management Settings	

## ►► Related Links

- "Setting Projector Event Schedules" [p.187](#)

**3** Select **Light Source Calibration** and press [Enter].

**4** Select any of the following:

- To run the light source calibration now, select **Run Now**.
- To automatically run the light source calibration every 100 hours of projector usage, select **Run Periodically** and set it to **On**.
- To check the last time the projector performed a calibration, see **Last Run**.



If you use the projector continuously for more than 24 hours or use direct shutdown regularly, select **Schedule Settings** to schedule calibration of the light source periodically.

To schedule automatic calibration, select **Schedule Settings**.

**5** When you are finished, press [Menu] to exit the menus.

You can combine the projected images from multiple projectors to create one bright image or a large seamless image (Multi-Projection).

The number of projectors that can be used depends on the function and method.

- Projecting one large image by compositing several images
  - Using the projector's menu with an optional external camera: up to 2 projectors (simple blending)
  - Using the Epson Projector Professional Tool Software and an optional external camera, or using the projector's menu: up to 15 projectors (blending)
- Projecting a bright image by overlaying images
  - Using the Epson Projector Professional Tool software with the optional external camera: up to 6 projectors (stacking)
  - Using the projector's menu with the optional external camera: up to 2 projectors (simple stacking)

## ► Related Links

- "Conditions for the Camera Correction Function" [p.120](#)
- "Procedure Overview" [p.120](#)
- "Preparing for Multi-Projection" [p.121](#)
- "Image Composition" [p.123](#)
- "Adjusting Colors" [p.130](#)
- "External Camera Usage" [p.131](#)

---

## Conditions for the Camera Correction Function

We recommend meeting the following conditions when using the camera correction function.

- An optional external camera is installed on each projector.
- Wait for 2 minutes after turning on two projectors before starting the simple stacking process.

- You are projecting on a matte white diffusion screen that is flat and even.
- The projector is placed so it squarely faces the screen, not at an angle.
- Nothing is blocking the optional external camera and the projected image.
- The illuminance ratio on the screen surface when projecting an all-white screen and when projecting an all-black screen is 8:1 or more. (When the screen illuminance is 40 lux or less, the projection size within the following range is recommended.)
  - Up to 9.9 Klm: 50 to 200 inches
  - 10 Klm to 14.9 Klm: 60 to 300 inches
  - 15 Klm to 19.9 Klm: 70 to 350 inches
  - 20 Klm to 24.9 Klm: 80 to 400 inches
  - 25 Klm to 29.9 Klm: 90 to 450 inches
  - 30 Klm or more: 100 to 500 inches
- The original resolution of all the projector is same.
- **Projection** in the projector's **Installation** menu is set to **Front** or **Front/Ceiling** for all projectors.

---

## Procedure Overview

We recommend using the following procedure for Multi-Projection.

### Preparation

- Connecting projectors
- Initializing projectors
- Assigning a primary projector
- Calibrating projectors
- Installing projectors
- Performing rough image adjustments
- Connecting projectors to a network



## Image Composition

- Blending
- Tiling
- Stacking

## Adjusting colors

- Adjust the Hue, Saturation, and Brightness settings for individual image colors.
- Adjust the overall tint of the image.

---

## Preparing for Multi-Projection

This section explains how to perform basic settings before installing the projector and preparing in advance for easier operations later.

### ▶▶ Related Links

- "Connecting Projectors" [p.121](#)
- "Initializing Projectors" [p.121](#)
- "Assigning a Primary Projector" [p.121](#)
- "Calibrating Projectors" [p.122](#)
- "Installing Projectors" [p.122](#)
- "Performing Rough Image Adjustments" [p.122](#)
- "Connecting Projectors to a Network" [p.122](#)
- "Projecting the Same Image in a Daisy-Chain Connection" [p.41](#)

## Connecting Projectors

Connect multiple projectors. For details, see "Projecting the Same Image in a Daisy-Chain Connection".

### ▶▶ Related Links

- "Projecting the Same Image in a Daisy-Chain Connection" [p.41](#)

## Initializing Projectors

You need to correct the difference in settings for each projector.

You can make the necessary settings as a batch by using **Batch Setup** before you start Multi-Projection in the projector's **Multi-Projection** menu.

Be sure to make the necessary settings for all of the projectors.

- Initializes the following:
  - Color Uniformity
  - Screen Matching
  - Color Matching
  - Image
  - Black Level
  - Brightness Level
- Changes the following:
  - **Multi-Projection** for Color Mode
  - **Off** for Dynamic Contrast
  - **Custom** for Light Source Mode
  - **Off** for Sleep Mode

## Assigning a Primary Projector

Select one projector to be the basis for adjustment.

Display test patterns from all projectors and select the one that has less color unevenness as the primary projector.



- We recommend displaying the following test patterns: **Grayscale, Gray Bars V, Gray Bars H, and White**
- When using the remote control, we recommend assigning the same ID for the primary projector and the remote control to limit the control target.

## Calibrating Projectors

Perform the following operations for all projectors to adjust the color balance and brightness that has deteriorated over time, and minimize the color tone difference between each projected image:

- Perform light source calibration.
  - ☛ **Management > Light Source Calibration**
- Perform color calibration if you install the optional external camera.
  - ☛ **Management > Color Calibration**
- Perform **Color Uniformity** if you do not install the optional external camera or you were unsuccessful performing color calibration.
  - ☛ **Multi-Projection > Color Uniformity**
  - ☛ **Management > Color Uniformity**
- Set the **Color Mode** setting to **Multi-Projection**.
  - ☛ **Image > Color Mode**



We recommend that you set **Run Periodically** to **Off** in the **Light Source Calibration** menu. If you set **On**, the color adjusted in multi-projection may be changed due to auto calibration.

## Installing Projectors

Install all projectors in an appropriate location.

When you install the primary projector in the center, you can easily calibrate colors because any unevenness at the center of the projected area is reduced.

## Performing Rough Image Adjustments

Perform the following operations for all projectors to adjust the position and the shape for rectangular projected images.

Displaying the test pattern makes it easier to adjust the projection position and the shape.

- For projection position, adjust the location, the angle, and the lens shift.
- For projection size, adjust the location and the zoom.
- For image focus, adjust the focus.



- The projected images are not stable right after turning on the projector. We recommend adjusting the projector at least 30 minutes after you start projecting.
- We recommend displaying the following test patterns: **Grayscale, Gray Bars V, Gray Bars H, and White**
- When adjusting the image height with vertical lens shift, adjust it by moving the image from the bottom to the top. If you adjust it from the top to the bottom, the image position may move down slightly after adjusting.
- It is not recommended that you perform geometry correction for the following reasons:
  - Image quality may decline.
  - If the correction value is too large, image calibration may be difficult.

## Connecting Projectors to a Network

Connect all projectors to the network hub with LAN cables.

When a connection is established, check that all projectors have been assigned their own IP address assigned.



If you are combining images from multiple projectors on a network, you can assign one projector as the "primary" and automatically adjust all the images to match the "primary" image. If the projectors are not connected to a network, you can match each projector's images manually.

## Image Composition

You can create a bright composite image and a large image from multiple projectors.

Choose an adjustment method for composing images based on your environment.

- If you have installed the optional external camera, you can easily adjust image by using the projector's menu.
- If you have installed the optional external camera and the Epson Projector Professional Tool software is available, you can automatically adjust image by using the Camera Assist function of the Epson Projector Professional Tool software.
- If you have not installed the optional external camera or the Epson Projector Professional Tool software is not available, you can manually adjust image using the projector's menu.



- You can download the Epson Projector Professional Tool software and its manual from the following website.  
[epson.sn](http://epson.sn)
- When compositing projected images using the camera assist feature in the Epson Projector Professional Tool software, the following functions support curved surfaces.
  - Screen Matching (convex surfaces are not supported)
  - Color Calibration
  - Blending
  - Stacking
  - Stacking & Blending

### ▶▶ Related Links

- "Blending Using the Epson Projector Professional Tool Software and the Optional Camera" [p.123](#)
- "Tiling Using the Projector's Menu" [p.124](#)
- "Simple Blending Using the Projector's Menu and the Optional External Camera" [p.128](#)
- "Stacking Using the Epson Projector Professional Tool Software and the Optional Camera" [p.129](#)
- "Stacking Using the Projector's Menu (Simple Stacking)" [p.129](#)
- "Stacking & Blending Using the Epson Projector Professional Tool Software" [p.130](#)

## Blending Using the Epson Projector Professional Tool Software and the Optional Camera

You can project one large image from up to 15 projectors using the optional external camera and the Epson Projector Professional Tool software.

See the *Epson Projector Professional Tool Operation Guide* for details.

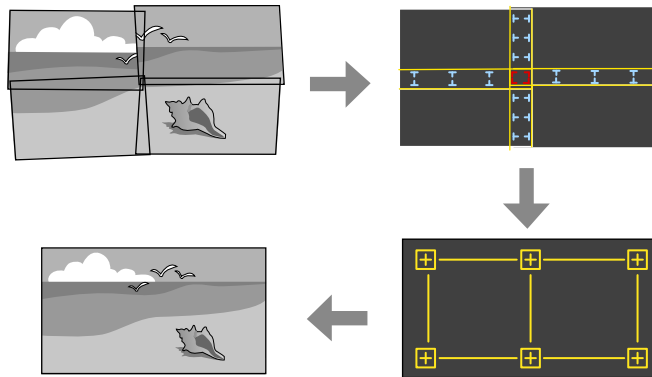

- 1** Start the Epson Projector Professional Tool software.
- 2** Create a group of projectors on the **Layout/Monitoring** tab.
- 3** Specify each projector's position using **Tiling and Stacking Settings** on the **Edit Group** screen.
- 4** Start the **Geometry Assist - Blending Function** wizard.

When the wizard has finished, perform the following operations as necessary:

- **Screen Matching** to correct the tint and brightness of each projected image.
- **Point Correction** to adjust the gaps in the positions of the projected image.
- **Scale** to crop and/or scale portions of the image.



- The required time for configuring tiling automatically varies depending on the layout and number of projectors. It takes up to approximately 8 minutes.
- The required time for screen matching varies depending on the layout and number of projectors. It takes up to approximately 18 minutes.

## Tiling Using the Projector's Menu

If you have not installed the optional external camera or the Epson Projector Professional Tool software is not available, you can project one large image from up to 15 projectors using the projector's menu. This section explains how to adjust the images from all projectors manually.

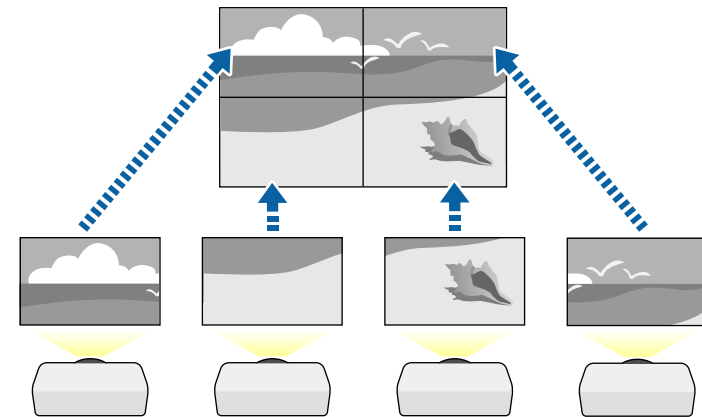

- 1** Select the **Projector ID** setting in the projector's **Multi-Projection** menu, and give each projector a unique ID to control multiple projectors from a remote control.
- 2** Set the remote control's ID to match the projector's ID to operate only a particular projector. Press the [ID] button on the remote control, and then press the numeric button that matches the projector's ID within 5 seconds. (Enter a one-digit number.)
- 3** If you are combining images from multiple projectors on a network, select the **Projector Grouping** setting on the primary projector and create a group of projectors that you can control simultaneously.
- 4** Select **Group Tiling** setting in the projector's **Multi-Projection** menu on the primary projector, and press [Enter].

- 5** Select **Tiling** and press [Enter].
- 6** Select the **Tiling** setting to adjust the arrangement of the images to create one large image.
  - If you have installed the optional external camera, select **Auto** on the primary projector.
  - If you have not installed the optional external camera or tiling the images automatically was unsuccessful, select **Manual**.
  - When selecting **Manual**, select **Layout**, and then select the number of rows and columns you are setting up as the **Row** and **Column** settings.
  - After making the **Layout** settings, select **Location Setup**. Select the position of each projected image as follows: **Row Order** to layout the screens from top to bottom in sequential order starting with 1 at the top, **Column Order** to layout the screens from left to right starting with A on the left.

1A	1B	1C
2A	2B	2C
3A	3B	3C

- Select the **Layout** and **Location Setup** settings on each projector you are setting up.

- 7** Select the input signal to display an image.
- 8** Select **Edge Blending** to adjust the edges of the images.
  - Set the **Edge Blending** setting to **Blending/Black Level** and turn on the **Line Guide** and **Pattern Guide** settings first.
  - Select the edge you want to blend on each projector, and set the **Blending** setting to **On**.
  - Select the **Blend Start Position** setting and adjust the blending start position.
  - Select the **Blend Range** setting and use the arrow buttons to select the width of the blended area so that the displayed guides are at the edges of the overlapping area between the two images.

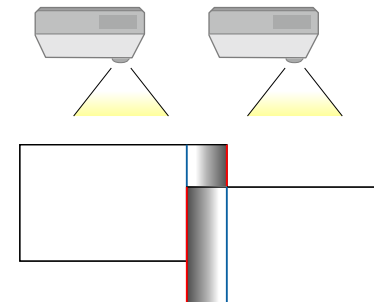

- Select the **Blend Curve** setting and select a gradient for the shaded area on the projectors.
- When the edges are blended, turn off the **Line Guide** and **Pattern Guide** settings on each projector to check the final settings.
- 9** Select the **Black Level** settings to make the difference less noticeable for the overlapping areas.
    - Select **Color Adjustment** first.
    - The adjustment areas are displayed based on the **Edge Blending** setting.

- Use the arrow buttons to select the area you want to adjust and press [Enter].

The selected area is displayed in orange. Adjust the black tone.

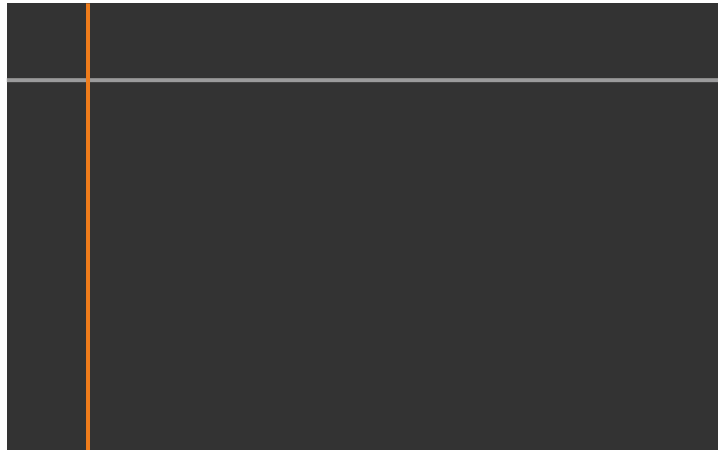

- When multiple screens are overlapping, adjust based on the area with the most overlap (the brightest area). In the illustration below, first align (2) with (1), and then adjust so that (3) aligns with (2).

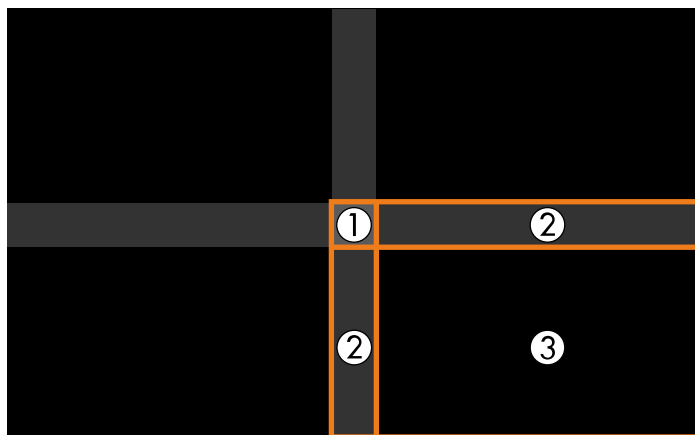

- Repeat these steps as needed to adjust any remaining screen areas.

- When you are finished, press the [Esc] button.

**10** If there are areas where the color does not match, select **Area Correction**.

- Select **Start Adjustments** first.

Boundary lines indicating where images overlap are displayed. The lines are displayed based on the **Edge Blending** setting.

- Use the arrow buttons to select the boundary line you want to adjust, and then press [Enter].

The selected line is displayed in orange.



- Use the arrow buttons to adjust the line position, and then press [Enter]. Next, use the arrow buttons to select the point you want to move, and then press [Enter].

The selected point is displayed in orange. You can move the point using the arrow buttons.

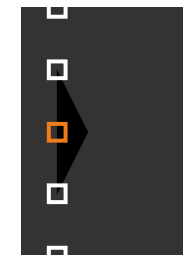



- You can change the number of the displayed points using the **Points** setting.
- To continue to move another point, press [Esc] and then repeat the previous steps.
- To adjust another boundary line, press [Esc] until the screen is displayed.

**11** If you are combining images from multiple projectors on a network, select the **Screen Matching** setting to adjust the brightness and tint of the images.



The required time for screen matching varies depending on the layout and number of projectors. It can take up to approximately 18 minutes.

**12** If the projectors are not connected to a network or you want to adjust manually after performing automatic adjustments, select the **Color Matching** setting to adjust the brightness and tint of the images manually.

- Select a value for the **Adjustment Level** setting, and adjust the color tone for the **Red**, **Green**, or **Blue** settings, and then adjust the **Brightness** setting.
- Repeat these steps as necessary to adjust each adjustment level.

**13** Select the **Scale** setting to select sections of the images.

- Set the **Scale** setting to **Auto** or **Manual** first.
- Select the **Scale Mode** setting and select one of the following options:
  - **Zoom Display** to maintain the image aspect ratio as you scale the image.



- **Full Display** to adjust the image to the projector's screen size as you scale the image.



- Select one or more of the following scaling options and adjust it as necessary:
  - **Scale V/H** to scale the image horizontally and vertically at the same time.
  - **Scale Vertically** to scale the image vertically only.
  - **Scale Horizontally** to scale the image horizontally only.

- Select the **Clip Adjustment** setting and use the arrow buttons to adjust the coordinates and size of each image as you view the screen.
- Select **Display Clip Range** to preview the clipped area you selected.

## Simple Blending Using the Projector's Menu and the Optional External Camera

You can create a horizontally wide screen image projected from two projectors using the optional external camera.

This function is only available when the optional external camera is installed, and the projectors are connected with a distributor.

- 1** Connect two projectors using a LAN cable.
- 2** Make sure the DHCP setting is turned on in the projector's Network menu for two projectors.



Wait for 1 minute after assigning an IP address automatically.

- 3** Select **Multi-Projection > Camera Correction Assist > Simple Blending**, and press [Enter]. Select Yes if necessary.
- 4** Select the **Location Setup** setting and specify the position of the primary projector from A1, B1, or C1.

- 5** Select the image aspect in the **Whole Screen Aspect** setting for the merged wide image.



You can set the following aspects using the **Whole Screen Aspect** menu.

Selectable items vary depending on the screen type setting.

- 21:9 (EDID 3440x1440)
- 21:9 (EDID 2560x1080)
- 16:6 (EDID 2880x1080)
- 16:6 (EDID 1920x720)
- 3:1 (EDID 3240x1080)
- 32:10 (EDID 3456x1080)
- 32:9 (EDID 3200x900)

- 6** Perform **Start Auto Adjustment**. If the projection position cannot be adjusted fully using lens shift dials, move the projectors so that the green pattern and the magenta pattern overlap and become white.
- 7** After auto adjustment is complete, perform **Correct Shape** following the instructions on the screen.
- 8** Perform **Screen Matching** to adjust the brightness and tint of the images.

When the automatic adjustment has finished, if there are any gaps in the pixels of the projected images, adjust the **Point Correction** setting manually.



## Stacking Using the Epson Projector Professional Tool Software and the Optional Camera

You can create one bright image by overlaying images from up to 6 projectors using the optional external camera and the Epson Projector Professional Tool software.

See the *Epson Projector Professional Tool Operation Guide* for details.

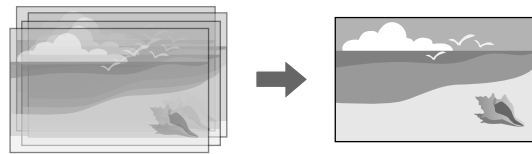

- 1** Start the Epson Projector Professional Tool software.
- 2** Create a group of projectors on the **Layout/Monitoring** tab.
- 3** Specify each projector's position using **Tiling and Stacking Settings** on the **Edit Group** screen.
- 4** Start the **Geometry Assist - Stacking Function** wizard.

When the wizard has finished, if there are any gaps in the pixels of the projected images, adjust the **Point Correction** setting manually.



The required time to automatically configure stacking varies depending on the layout and number of projectors. It can take up to approximately 9 minutes.

## Stacking Using the Projector's Menu (Simple Stacking)

If the Epson Projector Professional Tool software is not available, you can create one bright image by overlaying images from up to 2 projectors using the projector's menu.

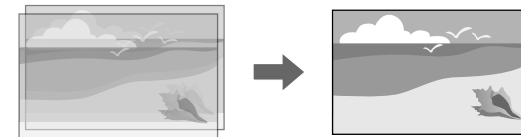

This function is only available when the optional external camera is installed.

- 1** Connect two projectors using a LAN cable.
- 2** Make sure the **DHCP** setting is turned on in the projector's **Network** menu for two projectors.  
  - ☛ **Network > Network Settings > Wired LAN > IP Settings > DHCP**



Wait for 1 minute after assigning an IP address automatically.

- 3** Select **Multi-Projection > Camera Correction Assist > Simple Stacking > Point Correction**, and adjust the image position, shape, and focus on one of the projectors (this projector becomes the primary projector), using the **Quick Corner** menu.
- 4** Select **Start Auto Adjustment** and follow the on-screen instructions.

When the automatic adjustment has finished, if there are any gaps in the pixels of the projected images, adjust the **Point Correction** setting manually.



- The required time for simple stacking varies depending on the projector layout. It can take up to approximately 5 minutes.
- If you have not installed the optional external camera, adjust the following settings manually:
  - Focus
  - Zoom
  - Lens Shift
  - Geometry Correction

## Stacking & Blending Using the Epson Projector Professional Tool Software

You can use the **Geometry Assist - Stacking & Blending Function** wizard to easily and quickly create a single large, bright, projected image by joining and overlapping the images of multiple projectors.

See *Epson Projector Professional Tool Operation Guide* for more details.

- 1** Start the Epson Projector Professional Tool software.
- 2** Create a group of projectors that support Stacking & Blending on the **Layout/Monitoring** tab.
- 3** Select **Blending and Stacking Settings** on the **Create Group** screen.
- 4** Specify the projectors' positions in the **Blending and Stacking Settings**.
- 5** Start the **Geometry Assist - Stacking & Blending Function** wizard. When the wizard has finished, perform the following operations as necessary:
  - **Screen Matching** to correct the tint and brightness of each projected image.

- **Point Correction** to adjust the gaps in the positions of the projected image.

---

## Adjusting Colors

Display the test patterns from all projectors to check each color tone.

If you need adjust the color tone, perform the following operations:

- Adjust the Hue, Saturation, and Brightness settings for individual image colors.
  - ☛ **Image > RGBCMY**
- Adjust the overall tint of the image.
  - ☛ **Image > White Balance**



We recommend displaying the following test patterns:  
Gray Bars V, Gray Bars H, and White

When you install the optional external camera on the projector, you can use the following functions to help you adjust the image.

- Adjust the image automatically using the Epson Projector Professional Tool software (Camera Assist function).
- Create a bright projected image by overlapping the images from two projectors (Simple Stacking).
- Create a horizontally wide screen image projected from two projectors (Simple Blending).
- Check the image you captured using the optional external camera in Epson Web Control (Remote Camera Access).
- Correct differences in the tint and brightness between projectors to optimize the display quality of the combined image (Screen Matching).
- Adjust the color tone of the entire screen when it has declined over time (Color Calibration).

The external camera should be mounted on a projector, a lens unit, or a camera tripod. There is also no need to adjust the focus, angle, and exposure.

See the external camera manual for the installation method.



You can download the Epson Projector Professional Tool software and manual from the following website.

[epson.sn](http://epson.sn)

## ▶▶ Related Links

- "Connecting to an Optional Camera" [p.131](#)

---

## Connecting to an Optional Camera

You can connect an optional external camera ELPEC01 to your projector to adjust images projected from multiple projectors.

After attaching the external camera ELPEC01 to your projector by referring to the ELPEC01 *User's Guide*, secure the USB cable that comes with the ELPEC01 to the projector as shown.

If the USB cable that came with the projector is too short when mounting on a camera tripod, you can use a commercially available USB cable instead.



- Set the possible extension length according to the instructions provided with the commercially available cable.
- When using commercially available cables to extend the communication distance, perform thorough operational testing beforehand, and use at your own risk.
- We cannot guarantee operation with all commercially available cables.

Before you start, make sure you have the following items:

- Commercially available cable tie × 1

- 1** After installing the external camera, secure the USB cable through the path on the bottom of the projector.

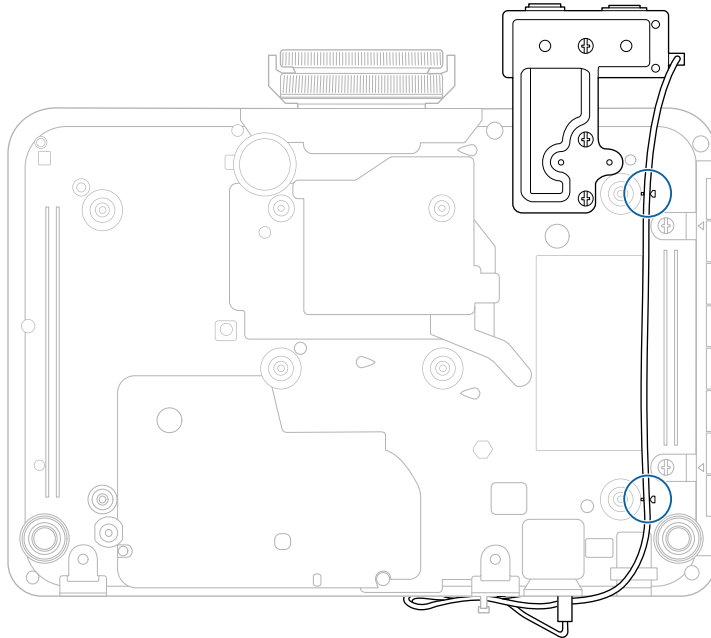

- 2** After connecting the end of the USB cable to the projector, loop the cable tie through the cable holder of the projector, and then fold the USB cable and fix with the cable tie.

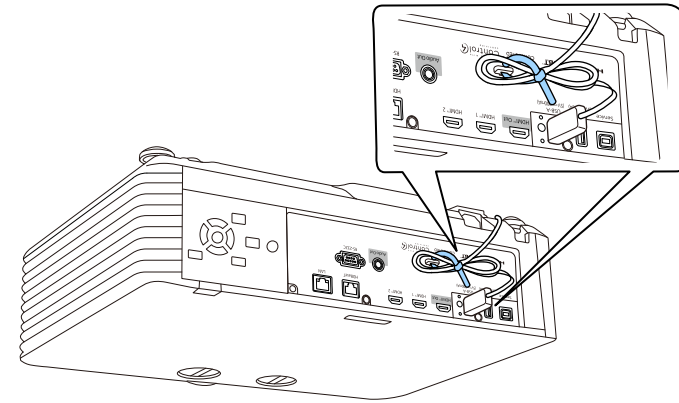

You can secure your projector to deter theft or prevent unintended use by setting up the following security features:

- **Password security** to prevent people who do not know the password from using the projector, and prevent changes to the startup screen and other settings.  
This acts as an anti-theft function as the projector cannot be used even if it is stolen, and you can limit who can use the projector.
- **Button lock security** to block operation of the projector using the buttons on the control panel.  
This is useful at events or shows when you want to deactivate all buttons during projection or at schools when you want to limit button operation.
- **Security cabling** to physically secure the projector in place.

#### ▶▶ Related Links

- "Password Security Types" [p.133](#)
- "Locking the Projector's Buttons" [p.135](#)
- "Locking the Remote Control Buttons" [p.136](#)
- "Installing a Security Cable" [p.137](#)

## Password Security Types

You can set up the following types of password security using one shared password:

- **Power On Protection** prevents anyone from using the projector without first entering a password. When plugging the power cord and turning on the projector, you must enter the correct password. This also applies to **Direct Power On** and **Auto Power On**.
- **Menu Protection of User's Logo** prevents anyone from changing the custom screen displayed when the projector turns on or receives an input signal. The custom screen deters theft by identifying the projector's owner.
- **Menu Protection of Schedule** prevents anyone from changing the projector's schedule settings.

- **Menu Protection of Network** prevents anyone from changing the projector's **Network** settings.

#### ▶▶ Related Links

- "Setting a Password" [p.133](#)
- "Selecting Password Security Types" [p.134](#)
- "Entering a Password to Use the Projector" [p.135](#)

## Setting a Password

For the first time you use the projector, you must set a password.



No password is set by default. You must set a password.

- 1 Hold down the [Freeze] button on the remote control for about 5 seconds.

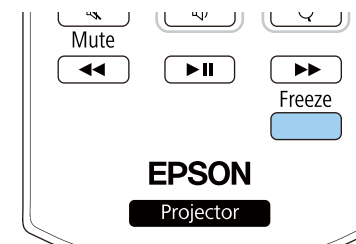

You see the Password Protection setting menu.



- If no password has been set, a screen prompting you to set a password is displayed before you can view the **Password Protection** setting menu.
- If **Password Protection** is already activated, you must enter the correct password to display the **Password Protection** setting menu.

- 2** Select **Password** and press [Enter].

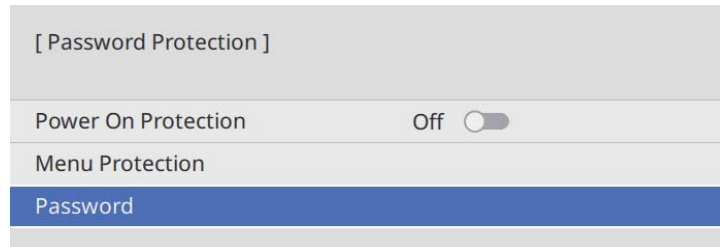

You see the prompt **Change the password?**.

- 3** Select **Yes** and press [Enter].



If you select **No**, the Password Protection setting menu is displayed again.

- 4** Use the numeric buttons on the remote control to set a four-digit password.

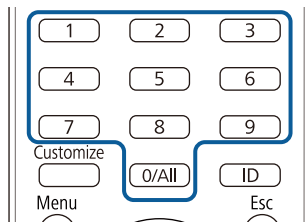

The password displays as \*\*\*\* as it is entered. A confirmation prompt is displayed when you enter the fourth digit.

- 5** Enter the password again.

You see the message **Password accepted**. If you enter the password incorrectly, a message is displayed prompting you to re-enter the password.

- 6** Press [Esc] to return to the menu.

- 7** Make a note of the password and keep it in a safe place.

## Selecting Password Security Types

After setting a password, you see this menu, allowing you to select the password security types you want to use.

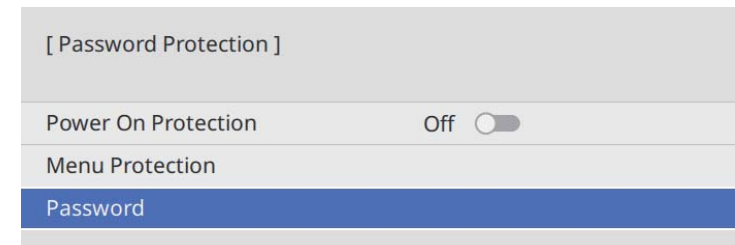

If you do not see this menu, hold down the [Freeze] button on the remote control for 5 seconds until the menu appears.

- To prevent unauthorized use of the projector, set the **Power On Protection** setting to **On**.
- To prevent changes to the projector's settings, select the **Menu Protection** setting, press [Enter], and select the options as necessary.
  - To prevent changes to the User's Logo screen or related display settings, set the **User's Logo** setting to **On**.
  - To prevent changes to the projector's schedule settings, set the **Schedule** setting to **On**.
  - To prevent changes to projector's network settings, set the **Network** setting to **On**.

You can attach the password protect sticker to the projector as an additional theft deterrent.



Be sure to keep the remote control in a safe place; if you lose it, you will not be able to enter the password.

## Entering a Password to Use the Projector

When the password screen is displayed, enter the correct password.

[ Password ]

Enter the new password.  
(4-digit number)

- 1 Enter the password using the numeric buttons on the remote control.

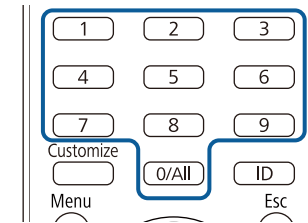

The password screen closes.

- 2 If the password is incorrect, you see a message and a prompt to try again. Enter the correct password to proceed.

### Attention

- If an incorrect password is entered three times in succession, the message **The projector's operation will be locked.** is displayed for approximately 5 minutes, and the projector switches to standby mode. If this happens, disconnect the power plug from the electrical outlet, reinsert it, and turn the projector back on. The projector displays the password entry screen again so that you can enter the correct password.
- If you have forgotten the password, make a note of the " **Request Code: xxxxx**" number that appears on the screen and contact Epson for help.
- If you continue to repeat the above operation and input the wrong password 30 times in succession, the message **The projector's operation will be locked. Contact Epson as described in your documentation.** is displayed and the projector does not accept any more password entries. Contact Epson for help.

## Locking the Projector's Buttons

You can lock the buttons on the control panel to prevent anyone from using the projector. The projector can still be operated using the remote control.

- 1 Press the [Menu] button, select the **Management** menu, and press [Enter].

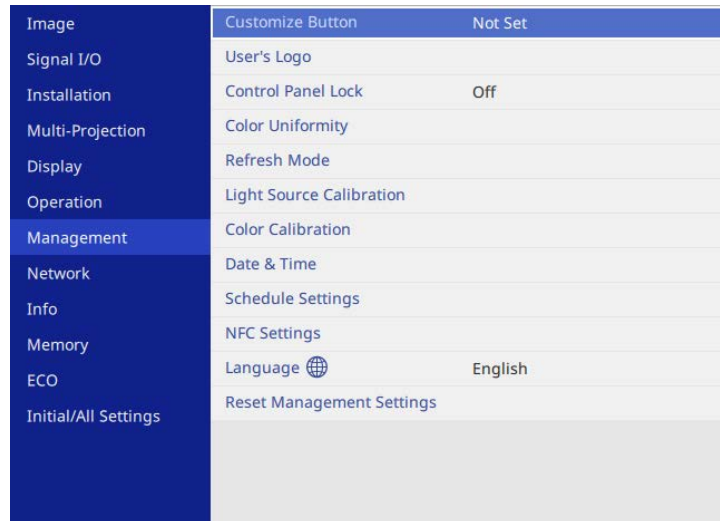

- 2 Select **Control Panel Lock** and press [Enter].

- 3 Select one of these lock types and press [Enter]:

- To lock all of the projector's buttons, select **Full Lock**.
- To lock all buttons except the power button, select **Except for Power**.

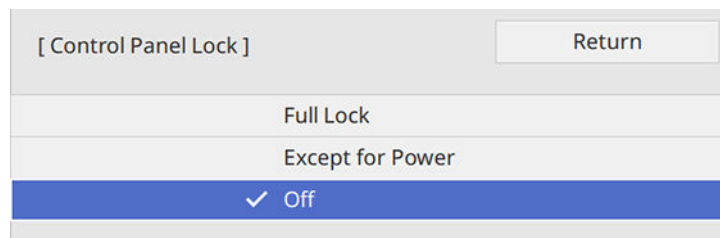

You see a confirmation prompt.

- 4 Select **Yes** and press [Enter].

The **Control Panel Lock** setting takes effect.

#### ▶▶ Related Links

- "Unlocking the Projector's Buttons" [p.136](#)

## Unlocking the Projector's Buttons

If the projector's buttons have been locked, do one of the following to unlock them.

- Hold down the [Enter] button on the control panel for 7 seconds. A message is displayed and the lock is released.
- Set the **Control Panel Lock** setting to **Off** in the projector's **Management** menu.

#### ▶▶ Related Links

- "Projector Administration Settings - Management Menu" [p.207](#)

## Locking the Remote Control Buttons

You can lock some of the buttons on the remote control.

To lock the remote control buttons shown here, press and hold the [Home] button on the remote control for approximately 5 seconds.

To unlock the buttons, press and hold the [Home] button again for approximately 5 seconds.



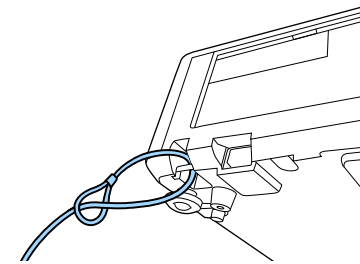
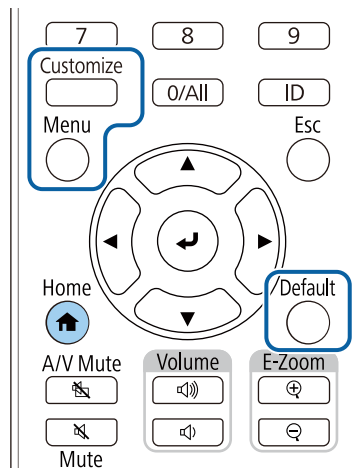

## Installing a Security Cable

You can install the security cable on the projector to deter theft.

- Use the security slot on the projector to attach a Kensington Microsaver Security system.



For more details on the Microsaver Security System, visit the Kensington Web site.

<https://www.kensington.com/>

- Use the security cable attachment point on the projector to attach a wire cable and secure it to a room fixture or heavy furniture.

# Using the Projector on a Network

Follow the instructions in these sections to set up your projector for use on a network.

## ► Related Links

- "Wired Network Projection" [p.139](#)
- "Wireless Network Projection" [p.143](#)
- "Wireless Network Projection from a Mobile Device (Miracast)" [p.153](#)
- "Using AirPlay" [p.157](#)
- "Secure HTTP" [p.161](#)
- "Screen Sharing" [p.163](#)

You can send images to your projector through a wired network. To do this, connect the projector to your network, and then set up your projector and computer for network projection.

After connecting and setting up the projector as described here, download and install Epson iProjection (Windows/Mac) from the following Web site.

[epson.sn](http://epson.sn)

Epson iProjection software sets up your computer for network projection. It also allows you to hold interactive meetings by projecting user's computer screens over a network. See the *Epson iProjection Operation Guide (Windows/Mac)* for instructions.



If the **Web Control Password** has not been set, a screen prompting you to set a password is displayed when you save the network settings. Follow the on-screen instructions to set the password.

## ► Related Links

- "Connecting to a Wired Network" [p.139](#)
- "Selecting Wired Network Settings" [p.139](#)

## Connecting to a Wired Network

To connect the projector to a wired local area network (LAN), use a 100Base-TX or 10Base-T network cable. To ensure proper data transmission, use a Category 5 shielded cable or better.

- 1** Connect one end of the network cable to your network hub, switch, or router.

- 2** Connect the other end of the cable to the projector's LAN port.

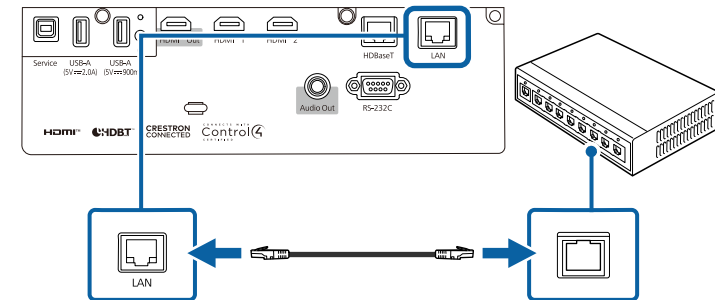

## Selecting Wired Network Settings

Before you can project from computers on your network, you need to select network settings on the projector.



Make sure you already connected the projector to your wired network using the LAN port.

- 1 Press the [Menu] button, select the **Network** menu, and press [Enter].

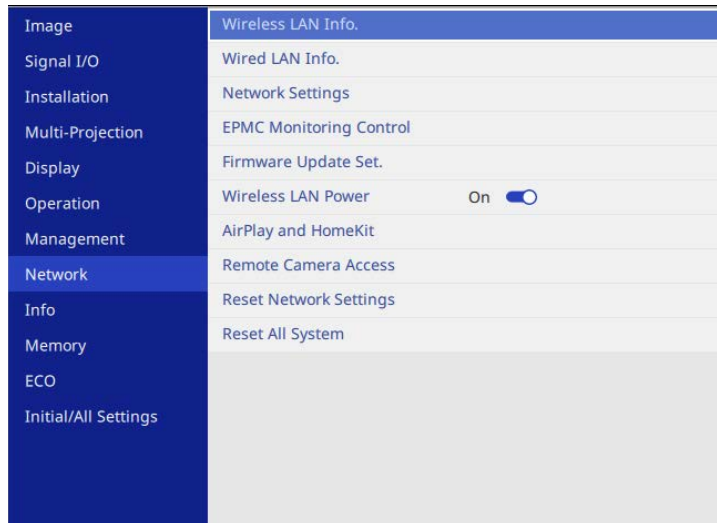

- 2 Select **Network Settings** and press [Enter].
- 3 To identify the projector over the network, select **Projector Name** and enter a name up to 16 alphanumeric characters long.
- 4 Set the **Priority Control Interface** setting to **Wired LAN**.

- 5 Select the **Wired LAN** menu and press [Enter].

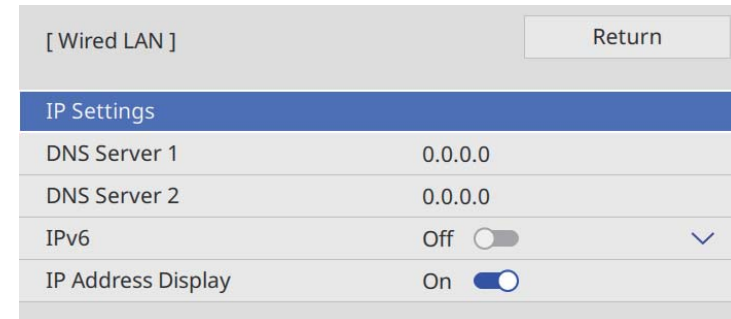

- 6 Assign the IP settings for your network as necessary.
  - If your network assigns addresses automatically, select **IP Settings** to set the **DHCP** setting to **On**.
  - If you must set addresses manually, select **IP Settings** to set the **DHCP** setting to **Off**, and then enter the projector's **IP Address**, **Subnet Mask**, and **Gateway Address** as necessary.
- 7 To prevent the IP address from being displayed on the network information screen, set the **IP Address Display** setting to **Off**.

- 8** Select the **Network Projection** menu and press [Enter].

[ Network Projection ]		Return
Projector Keyword	Off <input type="checkbox"/>	
Epson iProjection	On <input checked="" type="checkbox"/>	^
SSID Display	On <input checked="" type="checkbox"/>	
LAN Info. Settings	Text & QR Code	
Moderator Password		
Keyword Interrupt Display	Off <input type="checkbox"/>	
Miracast	On <input checked="" type="checkbox"/>	^
Access Control	01 <input type="checkbox"/>	
Secondary Connections		
Adjust Image Quality	1 (Fine)	
Miracast Info.	On <input checked="" type="checkbox"/>	
Message Broadcasting	Off <input type="checkbox"/>	
Screen Sharing	Off <input type="checkbox"/>	v

- 9** Turn on the **Projector Keyword** setting if you want to prevent access to the projector by anyone not in the room with it.



When you turn on this setting, you must enter a displayed, randomized keyword from a computer using Epson iProjection to access the projector and share the current screen.

- 10** Set the **Epson iProjection** setting to **On**.

- 11** Select the options as necessary.

- **SSID Display** lets you select whether to display projector's SSID on the network information screen and Home screen.

- **LAN Info. Settings** lets you set the display format for the projector's network information.
- **Moderator Password** lets you enter a four-digit number password for accessing the projector as a moderator using Epson iProjection. (No password is set by default.)
- **Keyword Interrupt Display** lets you select whether to display a projector keyword on the projected image when accessing the projector using Epson iProjection.

- 12** When you finish selecting settings, go back to the **Network Settings** screen, select **Set**, and follow the on-screen instructions to save your settings and exit the menus.



If no **Web Control Password** has been set, a screen prompting you to set a password is displayed before you can save the settings. Follow the on-screen instructions to set the password.

- 13** Press the [Wireless] button on the remote control to switch to the LAN source.

The wired network settings complete when you see the correct IP address on the network information screen.

[ LAN ]

Projector Name :

IP Address  :

Keyword :

Read the QR Code using the Epson iProjection app.



You can send images to your projector through a wireless network.

- To do this, you must install the Epson wireless LAN module, and then set up your projector and computer for wireless projection.
- Some models have built-in wireless LAN modules. You must set up your projector and computer for wireless projection.

You can connect the projector to your wireless network by configuring the connection manually using the projector's **Network** menus.

After setting up the projector, download and install the network software from the following Web site.

[epson.sn](http://epson.sn)

Use the following software and documentation to set up and control wireless projection:

- Epson iProjection (Windows/Mac) software allows you to hold interactive meetings by projecting the computer screens of users over a network. See the *Epson iProjection Operation Guide (Windows/Mac)* for instructions.
- Epson iProjection (iOS/Android) app allows you to project from iOS or Android devices.

You can download Epson iProjection for free from the App Store or Google Play. Any fees incurred when communicating with the App Store or Google Play are the responsibility of the customer.

- Epson iProjection (Chromebook) app allows you to project from Chromebook devices.

You can download Epson iProjection from the Chrome Web Store. Any fees incurred when communicating with the Chrome Web Store are the responsibility of the customer.



If the **Web Control Password** has not been set, a screen prompting you to set a password is displayed when you save the network settings. Follow the on-screen instructions to set the password.

## ► Related Links

- "Safety Instructions for Built-in Wireless LAN Module" [p.143](#)

- "Installing the Wireless LAN Module" [p.143](#)
- "Connection Methods for Wireless Network Projection" [p.144](#)
- "Selecting Wireless Network Settings Manually" [p.145](#)
- "Setting Up Wireless Network Security (When Simple AP is Enabled)" [p.148](#)
- "Setting Up Wireless Network Security (When Simple AP is Disabled)" [p.149](#)
- "Using a QR Code to Connect a Mobile Device" [p.151](#)
- "Using a USB Key to Connect a Windows Computer" [p.152](#)

## Safety Instructions for Built-in Wireless LAN Module

If your projector contains built-in wireless LAN modules, be sure to follow these important guidelines when using a wireless LAN connection.

### **Warning**

- Do not use the device near medical equipment such as pace makers. Furthermore, when using the device, make sure there is no medical equipment such as pace makers, in the surrounding area. Electromagnetic interference may cause medical equipment to malfunction.
- Electromagnetic interference may cause automatically controlled equipment to malfunction which could cause an accident. Do not use the device near automatically controlled equipment such as automatic doors or fire alarms.

### **Caution**

Make sure you keep a distance of at least 20 cm between the device and your body. Otherwise, it could cause you to feel unwell.

## Installing the Wireless LAN Module

To use the projector over a wireless network, install the Epson wireless LAN module (EB-L690SE/EB-L695SE). Do not install any other type of wireless LAN module.

## Attention

Never remove the module while its indicator is blue or flashing, or while you are projecting wirelessly. This could damage the module or lose data.



The indicator on the wireless LAN module does not operate. See the wireless LAN indicator on the projector to check the wireless LAN status.

- 1 Use a cross-head screwdriver to remove the screw that secures the wireless LAN module cover.

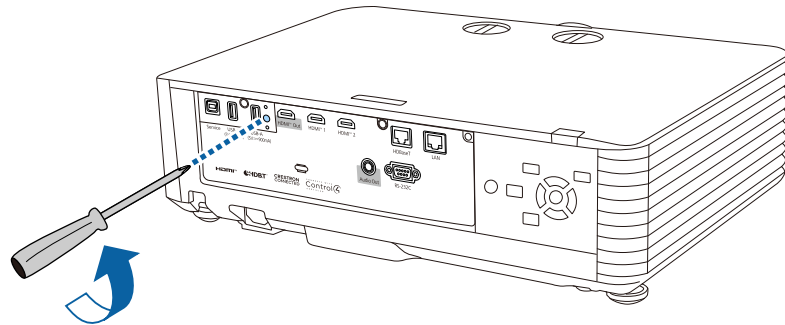

- 2 Connect the wireless LAN module to the USB-A port.

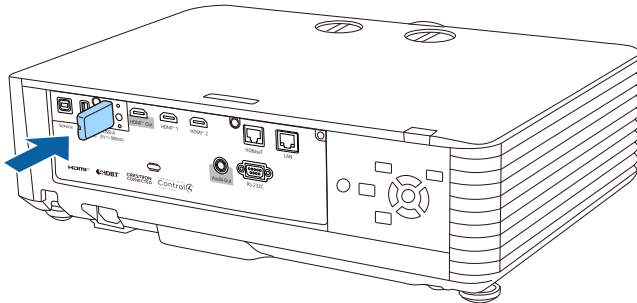

- 3 Attach the cover that comes with your wireless LAN module, and secure it in place with the screw.

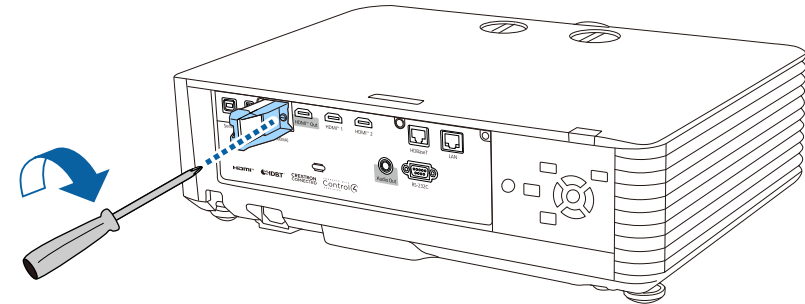

## Connection Methods for Wireless Network Projection

Choose a connection method for connecting your computer and projector over a network based on your network environment.

- Turning on simple AP mode lets you directly connect to smartphones, tablets, or computers using your projector as an access point. When you use this method, connect the projector using **Quick Connection Mode** of the Epson iProjection software, using Miracast, or using the optional wireless presentation system.





When monitoring or controlling the projector using wireless LAN in standby mode, set the **Simple AP** setting to **Off**, and connect your computer and projector.

If your projector has built-in wireless LAN modules, you can use both network connection methods at the same time. Set the **Simple AP** setting to **On**.

☛ **Network > Network Settings > Simple AP**

## Selecting Wireless Network Settings Manually

Before you can project from your wireless network, you need to select network settings for the projector.



To use the projector over a wireless network, install the Epson wireless LAN module (EB-L690SE/EB-L695SE).

- Turning off simple AP mode lets you connect to smartphones, tablets, or computers over a wireless network access point. Select this mode when connecting using Epson iProjection's **Advanced Connection Mode** (EB-L690SE/EB-L695SE).

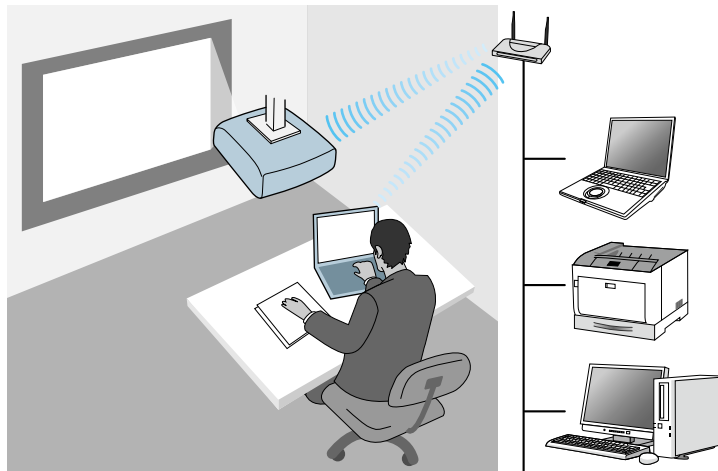

**1** Press the [Menu] button, select the **Network** menu, and press [Enter].

Image	Wireless LAN Info.
Signal I/O	Wired LAN Info.
Installation	Network Settings
Multi-Projection	EPMC Monitoring Control
Display	Firmware Update Set.
Operation	Wireless LAN Power <span style="float: right;">On <input type="checkbox"/></span>
Management	AirPlay and HomeKit
<b>Network</b>	Remote Camera Access
Info	Reset Network Settings
Memory	Reset All System
ECO	
Initial/All Settings	

- 2** Set the **Wireless LAN Power** setting to **On**.
- 3** Select **Network Settings** and press [Enter].
- 4** To identify the projector over the network, select **Projector Name** and enter a name up to 16 alphanumeric characters long.
- 5** Set the **Priority Control Interface** setting to **Wireless LAN**.
- 6** Select the connection method.
  - For simple AP mode, set the **Simple AP** setting to **On** and go to step 11.
  - For the access point connection, set the **Simple AP** setting to **Off** and go to next step.
  - If you want to use both connection methods at the same time, set the **Simple AP** setting to **On** and go to next step.
- 7** Select the **Wireless LAN** menu and press [Enter].

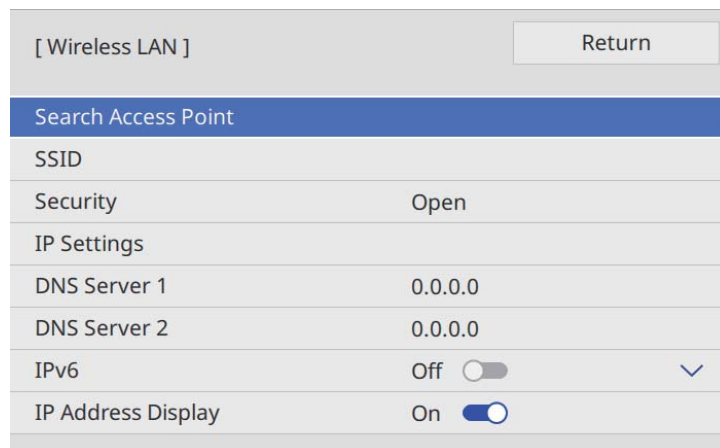

The projector starts searching for access points.



You can also search for access points using the **Search Access Point** setting manually.

- 8** Select the access point you want to connect to.



If you need to assign the SSID manually, select **SSID** to enter the SSID.

- 9** Assign the IP settings for your network as necessary.
  - If your network assigns addresses automatically, select **IP Settings** to set the **DHCP** setting to **On**.
  - If you must set addresses manually, select **IP Settings** to set the **DHCP** setting to **Off**, and then enter the projector's **IP Address**, **Subnet Mask**, and **Gateway Address** as necessary.
- 10** To prevent the IP address from being displayed on the network information screen, set the **IP Address Display** setting to **Off**.

- 11** Select the **Network Projection** menu and press [Enter].

[ Network Projection ]		Return
Projector Keyword	Off <input type="checkbox"/>	
Epson iProjection	On <input checked="" type="checkbox"/>	^
SSID Display	On <input checked="" type="checkbox"/>	
LAN Info. Settings	Text & QR Code	
Moderator Password		
Keyword Interrupt Display	Off <input type="checkbox"/>	
Miracast	On <input checked="" type="checkbox"/>	^
Access Control	01 <input type="checkbox"/>	
Secondary Connections		
Adjust Image Quality	1 (Fine)	
Miracast Info.	On <input checked="" type="checkbox"/>	
Message Broadcasting	Off <input type="checkbox"/>	
Screen Sharing	Off <input type="checkbox"/>	v

- 12** Turn on the **Projector Keyword** setting if you want to prevent access to the projector by anyone not in the room with it.



When you turn on this setting, you must enter a displayed, randomized keyword from a computer using Epson iProjection to access the projector and share the current screen.

- 13** Set the **Epson iProjection** setting to **On**.

- 14** Select the options as necessary.

- **SSID Display** lets you select whether to display projector's SSID on the network information screen and Home screen.

- **LAN Info. Settings** lets you set the display format for the projector's network information.
- **Moderator Password** lets you enter a four-digit number password for accessing the projector as a moderator using Epson iProjection. (No password is set by default.)
- **Keyword Interrupt Display** lets you select whether to display a projector keyword on the projected image when accessing the projector using Epson iProjection.

- 15** When you finish selecting settings, go back to the **Network Settings** screen, select **Set**, and follow the on-screen instructions to save your settings and exit the menus.



If no **Web Control Password** has been set, a screen prompting you to set a password is displayed before you can save the settings. Follow the on-screen instructions to set the password.

- 16** Press the [Wireless] button on the remote control to switch to the LAN source.

The wireless network settings are complete when you see the correct IP address on the network information screen.

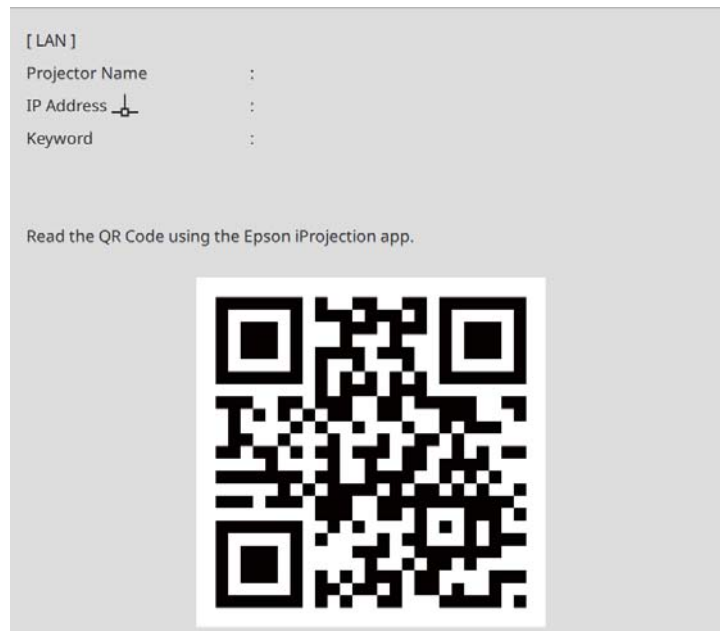

When you have finished making wireless settings for your projector, you need to select the wireless network on your computer. Then start the network software to send images to your projector through a wireless network.

#### ► Related Links

- "Selecting Wireless Network Settings in Windows" [p.148](#)
- "Selecting Wireless Network Settings in Mac" [p.148](#)

## Selecting Wireless Network Settings in Windows

Before connecting to the projector, select the correct wireless network on your computer.

- 1** To access your wireless utility software, click the network icon on the Windows taskbar.

- 2** When connecting to devices over a wireless network access point, make sure Wi-Fi is turned on and select the network name (SSID) of the network the projector is connecting to.

- 3** Click **Connect**.

## Selecting Wireless Network Settings in Mac

Before connecting to the projector, select the correct wireless network in Mac.

- 1** Click the Wi-Fi icon on the menu bar at the top of the screen.
- 2** When connecting to devices over a wireless network access point, make sure Wi-Fi is turned on and select the network name (SSID) of the network the projector is connecting to.

## Setting Up Wireless Network Security (When Simple AP is Enabled)

You can set up security for your projector to use on a wireless network with simple AP mode. You can use WPA2-PSK security.



Contact your network administrator for guidance on entering the correct information.

- 1** Press the [Menu] button, select the **Network** menu, and press [Enter].
- 2** Select **Network Settings** and press [Enter].

- 3 Select **Passphrase**, press [Enter], and enter a passphrase from 8 to 63 characters long.

- 4 When you finish entering a passphrase, go back to the **Network Settings** screen, select **Set**, and follow the on-screen instructions to save your settings and exit the menus.

## Setting Up Wireless Network Security (When Simple AP is Disabled)

You can set up security for your projector to use on a wireless network with infrastructure mode. Set up one of the following security types to match the settings used on your network:

- WPA3-PSK security
- WPA2/WPA3-PSK security
- WPA3-EAP security

- WPA2/WPA3-EAP security



Contact your network administrator for guidance on entering the correct information.

- 1 If you want to set up WPA3-EAP or WPA2/WPA3-EAP security, make sure your digital certificate file is compatible with projector registration type and placed directly on a USB storage device.
- 2 Press the [Menu] button, select the **Network** menu, and press [Enter].
- 3 Select **Network Settings** and press [Enter].
- 4 Select the **Wireless LAN** menu and press [Enter].

- 5 Select the **Security** setting and press [Enter].

- 6** Select the security settings to match your network settings.

- 7** Do one of the following according to the security you selected.
- **WPA3-PSK or WPA2/WPA3-PSK:** Select **Passphrase**, press [Enter], and enter a passphrase from 8 to 63 characters long. Then go to step 16.
  - **WPA3-EAP or WPA2/WPA3-EAP:** Select **EAP Type** and press [Enter].

- 8** Select the protocol for authentication as the **EAP Type** setting.

- 9** To import your certificate, select the certificate type and press [Enter].
- **Client Certificate** for the EAP-TLS type
  - **CA certificate** for all EAP types



You can also register the digital certificates using your Web browser. However, be sure to register just once or the certificate may not install correctly.

- 10** Select **Save** and press [Enter].
- 11** Follow the on-screen instructions to connect a USB storage device to the projector's USB-A port.
- 12** Press [Enter] to display the certificate list.
- 13** Select the certificate to import using the displayed list.  
A message is displayed prompting you to enter the password for the certificate.
- 14** Enter a password and press [Enter].  
The certificate is imported and a completion message appears.
- 15** Select your EAP settings as necessary.
- **User name** lets you enter a user name using up to 64 alphanumeric characters. When importing a client certificate, the name the certificate was issued to is automatically set.
  - **Password** lets you enter a password using up to 64 alphanumeric characters for authentication when using the **PEAP** type.
  - **RADIUS Server Name** lets you enter the server name to be verified.
- 16** When you finish making settings, go back to the **Network Settings** screen, select **Set**, and follow the on-screen instructions to save your settings and exit the menus.

#### » Related Links

- "Supported Client and CA Certificates" [p.150](#)

### Supported Client and CA Certificates

You can register these types of digital certificates.

## Client Certificate (EAP-TLS)

Specification	Description
Format	PKCS#12
Extension	PFX, P12
Encryption	RSA
Hashes	MD5/SHA-1/SHA-256/SHA-384/SHA-512
Key length	512/1024/2048/4096 bit
Password	Up to 64 alphanumeric characters; required

## CA Certificate (PEAP/EAP-TLS)

Specification	Description
Format	X509v3
Extension	DER/CER/PEM
Encryption	RSA
Hashes	MD5/SHA-1/SHA-256/SHA-384/SHA-512
Key length	512/1024/2048/4096 bit
Encoding	BASE64/Binary

## Using a QR Code to Connect a Mobile Device

After selecting the wireless network settings for your projector, you can display a QR code on the screen and use it to connect a mobile device using the Epson iProjection (iOS/Android) app.



- Make sure you have installed the latest version of Epson iProjection on your device.
- You can download Epson iProjection for free from the App Store or Google Play. Any fees incurred when communicating with the App Store or Google Play are the responsibility of the customer.
- When using Epson iProjection in Quick connection mode, we recommend making security settings.

- 1 Press the [Wireless] button on the remote control. The QR code is displayed on the projected surface.



- If you do not see the QR code, set the LAN Info. Settings setting to Text & QR Code in the projector's Network menu.  
 🖱️ **Network > Network Settings > Network Projection > Epson iProjection > LAN Info. Settings**
- To hide the QR code, press [Esc].
- When the QR code is hidden, press [Enter] to display the code.

- 2 Start Epson iProjection on your mobile device.

- 3 Read the projected QR code using Epson iProjection to connect it to the projector.



To correctly read the QR code, make sure you face the screen squarely and closely enough so that the projected code fits into the guide of the mobile device's QR code reader. If you are too far from the screen, the code may not be read.

When a connection is established, select **Contents** menu from , and then select the file you want to project.

## Using a USB Key to Connect a Windows Computer

You can set up your USB flash drive as a USB key to quickly connect the projector to a wireless LAN supported Windows computer. After creating the USB key, you can quickly project images from the network projector.

- 1** Set up the USB key using **USB Key Setup Tool** of the Epson iProjection (Windows/Mac) software.



See the *Epson iProjection Operation Guide (Windows/Mac)* for instructions.

- 2** Make sure the wireless LAN module is installed or built into your projector.
- 3** Turn on the projector.
- 4** Press the [Wireless] button on the remote control.  
You see the network information screen. Verify that an SSID and IP address are displayed.
- 5** Remove the wireless LAN module from the projector's USB-A port (if installed) and insert the USB key into the same port.  
You see a projected message that the network information update is complete.
- 6** Remove the USB key.  
If your projector needs the wireless LAN module, reinsert the wireless LAN module into the projector.
- 7** Connect the USB key to a USB port on your computer.

- 8** Follow the on-screen instructions to install the necessary application.



- If the Windows Firewall message is displayed, click **Yes** to disable the firewall.
- You need administrator authority to install the software.
- If it is not installed automatically, double-click **MPPLaunch.exe** in the USB key.

After a few minutes, your computer image is displayed by the projector.

- 9** When you have finished projecting wirelessly, select the **Safely Remove Hardware** option in the Windows taskbar, and then remove the USB key from your computer.



You may need to restart your computer to reactivate your wireless LAN connection.



You can send image to your projector from mobile devices such as laptops, smartphones, and tablets using Miracast technology.

If your device supports Miracast, you do not need to install any additional software. When using a Windows computer, make sure the necessary adapter for the Miracast connection is available.

Note the following limitations when using Miracast features.

- You cannot play an interlaced image.
- You cannot play multi-channel audio over 3ch (channel 3).
- You may not be able to project images depending the resolution and frame rate.
- You cannot play 3D video.
- You cannot view contents with copyright protection using a Miracast connection.
- Do not change the projector's Miracast setting during Miracast projection. Doing so may cause the projector to disconnect and it may take a while to re-connect.

☛ **Network > Network Configuration > Network Projection > Miracast**

- Do not turn off the projector directly by the breaker during Miracast projection.



- Mobile devices with Android installed or Windows 8.1 or later installed mainly support Miracast.  
Support for Miracast varies depending on the mobile device. See your mobile device manual for details.
- If the **Web Control Password** has not been set, a screen prompting you to set a password is displayed when you save the network settings. Follow the on-screen instructions to set the password.

## ▶ Related Links

- "Selecting Miracast Settings" [p.153](#)
- "Connecting with the Miracast Function" [p.154](#)
- "Connecting Using Miracast in Windows 10" [p.155](#)

- "Connecting Using Miracast in Windows 11" [p.156](#)

## Selecting Miracast Settings

You must select **Miracast** settings for your projector to project images from your mobile device.



If you use Windows 10 or Windows 11, you can cast images using the following connections:

- Casting images from your device to the projector directly
- Casting images via local area network

When you cast images via local area network, the connection is more stable and secure. Do one of the following to connect your projector to a local area network:

- Connect a LAN cable.
- Select the **Wireless LAN** setting to connect to the wireless access point.

- 1 Press the [Menu] button, select the **Network** menu, and press [Enter].

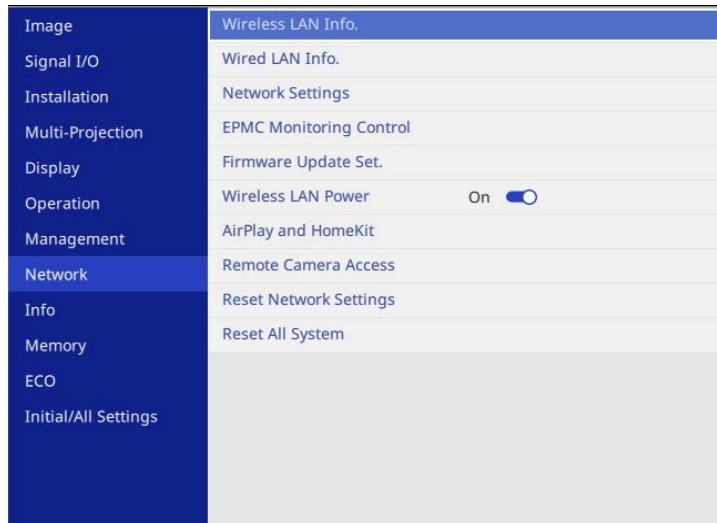

- 2 Set the **Wireless LAN Power** setting to **On**.
- 3 Select **Network Settings** and press [Enter].
- 4 Choose one of the following options:
  - If you cast the data via local area network using the wired LAN, select **Wired LAN**.
  - If you cast the data directly or via wireless access point, select **Wireless LAN**.
  - If your device only supports casting data directly, select **Wireless LAN**.
- 5 Set the **Simple AP** setting to **On**.



If no password has been set, a screen prompting you to set a password is displayed before you can set **Simple AP** to **On**.

- 6 Select **Network Projection**.
- 7 Set the **Miracast** setting to **On**.
- 8 Select the options as necessary.
  - **Access Control** lets you select whether or not to connect to another mobile device during Miracast projection.
  - **Secondary Connections** lets you select the connection behavior for devices attempting to connect during a Miracast connection.
  - **Adjust Image Quality** lets you adjust the Miracast speed/quality. Select a small number to improve the quality and select large number to increase the speed.
  - **Miracast Info.** displays connection information when projecting the Miracast source.
- 9 When you finish selecting settings, go back to the **Network Settings** screen, select **Set**, and follow the on-screen instructions to save your settings and exit the menus.



If no **Web Control Password** has been set, a screen prompting you to set a password is displayed before you can save the settings. Follow the on-screen instructions to set the password.

## Connecting with the Miracast Function

If your mobile device such as a smartphone supports Miracast, you can connect it to the projector wirelessly and project images. You can play audio through the projector's speaker system by connecting using Miracast.

- 1 Select the **Miracast** setting on your projector as necessary.

- 2** Press the [Wireless] button on the remote control to switch to the Miracast source.  
You see the network information screen.
- 3** On your mobile device, use your Miracast function to search for the projector.  
You see a list of available devices.
- 4** Select the projector's Projector Name from the list.  
The projector displays the image from your mobile device.



- When **Access Control** is set to **On**, select **Yes** on the displayed projection permission screen to start projection.  
You can also force the device to disconnect by pressing the [Esc] button on the remote control or the control panel during projection.
- It may take some time until the connection is established. While connecting, do not disconnect the projector's power cord. Doing so may cause your device to freeze or malfunction.  
Depending on the mobile device, you may need to delete a device when connecting. Follow the on-screen instructions on your device.

- 2** Press the [Wireless] button on the remote control to switch to the Miracast source.  
You see the network information screen.
- 3** Hold down the Windows key and press K on your keyboard at the same time.  
You see a list of available devices.
- 4** Select the projector's Projector Name from the list.  
The projector displays the image from your computer.



- When **Access Control** is set to **On**, select **Yes** on the displayed projection permission screen to start projection.  
You can also force the device to disconnect by pressing the [Esc] button on the remote control or the control panel during projection.
- It may take some time until the connection is established. While connecting, do not disconnect the projector's power cord. Doing so may cause your device to freeze or malfunction.

## Connecting Using Miracast in Windows 10

You can set up your computer for wireless projection and play audio through the projector's speaker system by connecting using Miracast.

- 1** Select the **Miracast** setting on your projector as necessary.

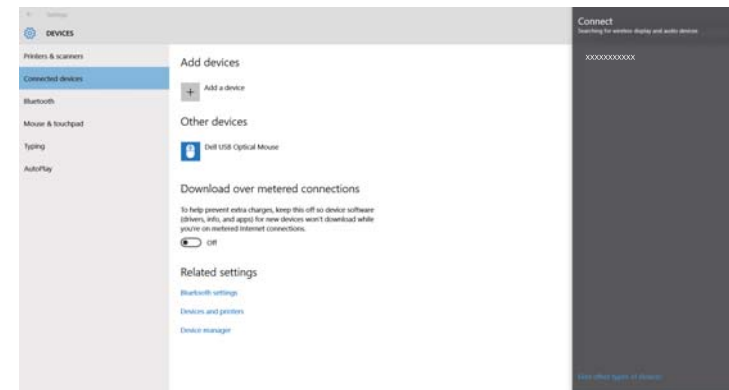

## Connecting Using Miracast in Windows 11

You can set up your computer for wireless projection and play audio through the projector's speaker system by connecting using Miracast.

- 1** Select the **Miracast** setting on your projector as necessary.
- 2** Press the [Wireless] button on the remote control to switch to the Miracast source.

You see the network information screen.

- 3** Click the speaker icon on your computer's taskbar.

- 4** Click **Cast**.

You see a list of available devices.



If **Cast** is not displayed or another message is displayed, see the manual supplied with the computer.

- 5** Select the projector's **Projector Name** from the list.

The projector displays the image from your computer.



- When **Access Control** is set to **On**, select **Yes** on the displayed projection permission screen to start projection.  
You can also force the device to disconnect by pressing the [Esc] button on the remote control or the control panel during projection.
- It may take some time until the connection is established. While connecting, do not disconnect the projector's power cord. Doing so may cause your device to freeze or malfunction.

You can stream media such as videos, music, and photos to the projector using Apple devices that support AirPlay. You can also mirror the entire screen of your Apple device.

This projector is compatible with HomeKit. When you register the projector with HomeKit on your Apple device, you can control the projector using the Apple Home app on your Apple device.



- When **Standby Mode** is set to **Normal** in the **Operation** menu, you can make AirPlay connections even if the projector is in standby mode (when the power is off).
- You need to connect to the internet to enable AirPlay. Make network settings in the **Network** menu. If you have never connected to the internet before, a screen is displayed indicating that you need to make network settings when you try to connect using AirPlay.
- You need to configure a DNS server to use AirPlay. Depending on your network, set **DHCP** to **On** in **IP Settings** from the **Wired LAN** menu or the **Wireless LAN** menu. If **DHCP** is set to **Off**, or if you want to specify a DNS server address, enter the IP address in **DNS Server 1** or **DNS Server 2**.
  - ☛ **Network > Network Settings > Wired LAN**
  - ☛ **Network > Network Settings > Wireless LAN**
- You cannot use AirPlay when the same access point is used for wired LAN and wireless LAN.
- To stream content that is not stored on your Apple device with AirPlay, set **Priority Control Interface** to **Wireless LAN** or **Wired LAN** according to the network to be used.
- The maximum display resolution is 1920 × 1080.
- You may not be able to use AirPlay to view copyright-protected content.
- The audio supports up to 2 channels with a maximum sampling frequency of 44.1 kHz.

▶ **Related Links**

- "Settings for AirPlay" [p.157](#)

- "Streaming/Mirroring Media with an AirPlay Connection" [p.159](#)

## Settings for AirPlay

When using AirPlay, make sure your Apple device and the projector are using the same network.

You can make AirPlay settings from the AirPlay and HomeKit settings screen.



- If the date and time are not correctly set on the projector, the AirPlay connection may be disconnected while projecting. Set the correct date and time in **Date & Time** and **Daylight Saving Time** from the **Management** menu.
- When using AirPlay, if there are no operations for about 10 minutes on the standby screen, the screen may turn black to prevent burn-in.

- 1** Change the source to something other than AirPlay.
- 2** Press the [Menu] button, select the **Network** menu, and press [Enter].

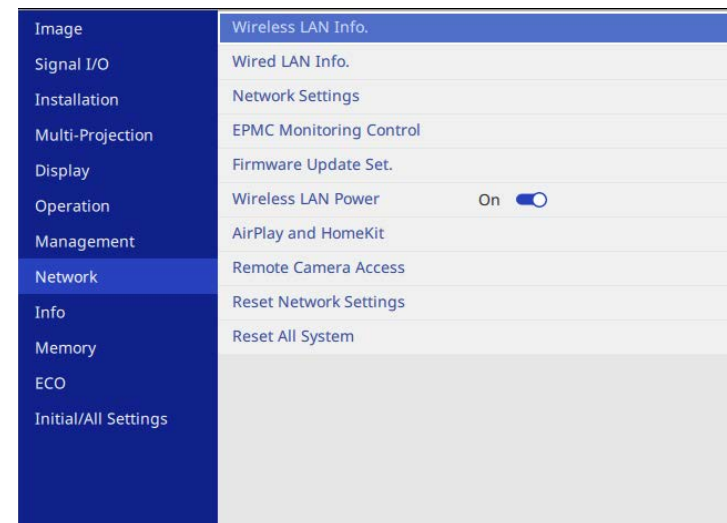

- 3 Select **AirPlay and HomeKit** in the **Network** menu and press [Enter]. The AirPlay and HomeKit settings screen is displayed.

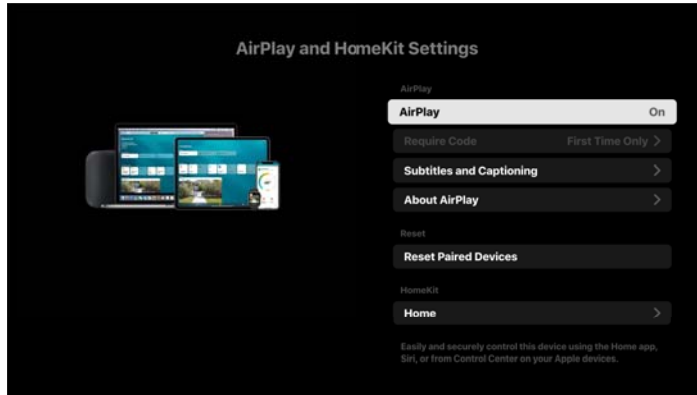

- 4 Set AirPlay to On.

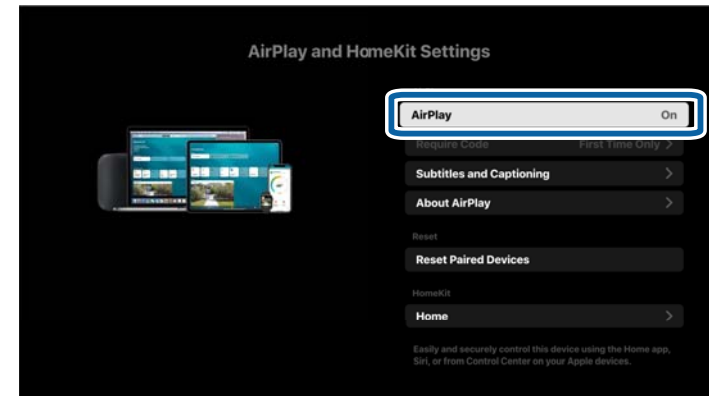

- 5 Change the other settings as needed.

To register with HomeKit, scan the projected QR code using your Apple device.

Once registered with HomeKit, you can control the projector and change the device name from the Home app on your Apple device.

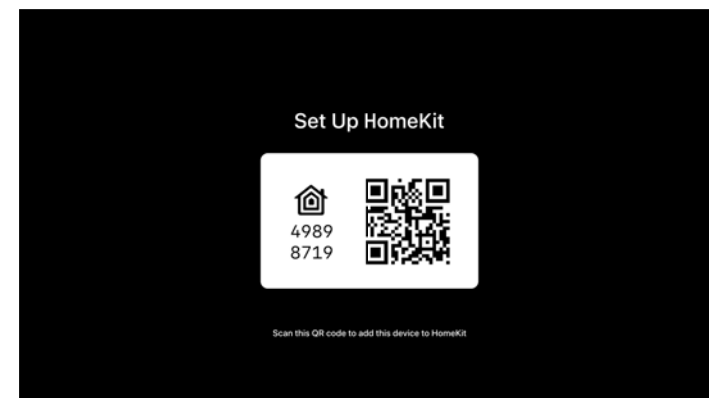

- When the source is AirPlay, you cannot select **AirPlay and HomeKit** from the **Network** menu. If you want to change the settings, stop playback on your Apple device. Display the AirPlay and HomeKit settings screen from the following screen that is displayed.

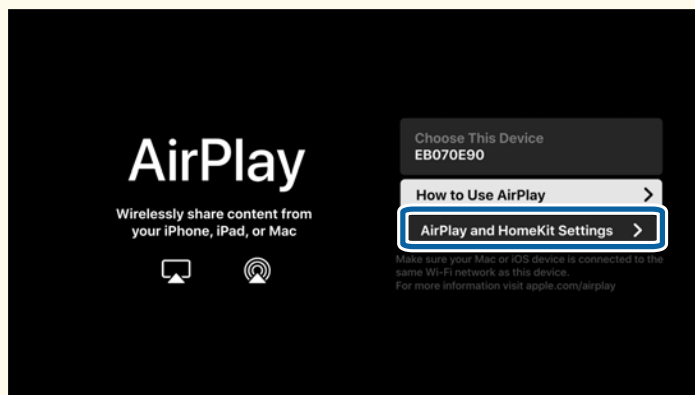

- When AirPlay is Off, the AirPlay and HomeKit settings screen is displayed when you set the source to AirPlay.



When changing the device name in the Home app, only characters that can be entered using the soft keyboard are available. You cannot use other characters.

► **Related Links**

- "Available Text Using the Displayed Keyboard" [p.192](#)

## Streaming/Mirroring Media with an AirPlay Connection

When using an Apple device that supports AirPlay, you can stream media such as videos, music, and photos to the projector. You can also mirror and display the entire screen of your Apple device.



When using AirPlay, if there are no operations for about 10 minutes on the standby screen, the screen may turn black to prevent burn-in.

- 1 On your Apple device, select the media you want to play using AirPlay and select the AirPlay icon (📺 or 📶).  
To mirror, open the Control Center and select the screen mirroring icon (🖥️).

- 2 Select the projector's device name from the list displayed on your Apple device.



- To check the projector's device name, stop media playback on your Apple device and press the [Wireless] button on the remote control until the following screen is displayed. You can also check it on the Home screen or LAN standby screen.

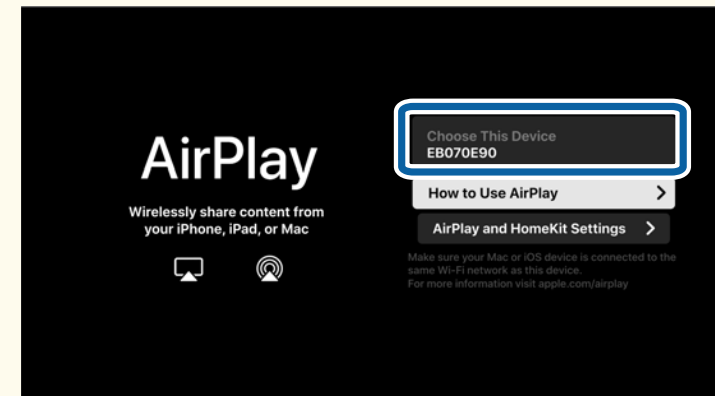

- When AirPlay is off, the projector's device name is not displayed in the list on your Apple device. Use one of the following operations to display the AirPlay and HomeKit settings screen, and then turn on AirPlay.
  - Press the [Wireless] button until the AirPlay and HomeKit settings screen is displayed.
  - Select **AirPlay and HomeKit** in the **Network** menu and press [Enter].

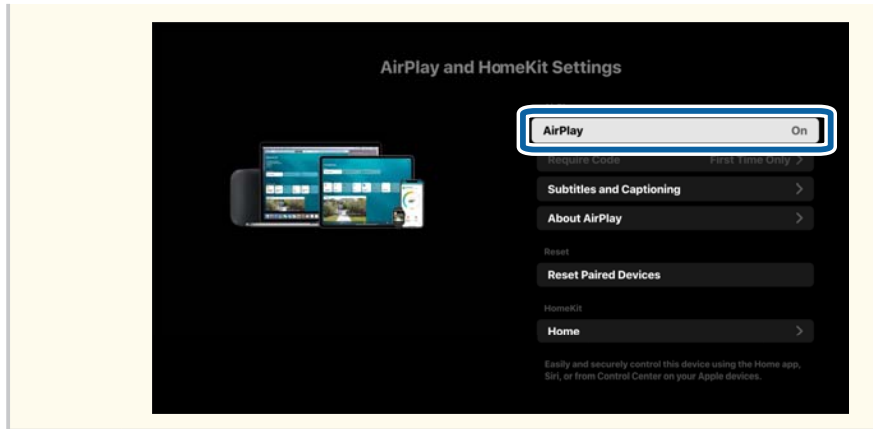

- 3** If the projector prompts you for a 4-digit PIN code, enter it on your Apple device.

Media streaming or mirroring of your Apple device screen starts.



When streaming, you can play, pause, fast-forward, rewind, change the volume, and mute using the projector's remote control.

- 4** To end the AirPlay connection, press [Esc].  
The screen that was displayed before the connection started is projected.



- You can also end the AirPlay connection by switching to a different target device or by canceling mirroring on your Apple device.
- The AirPlay connection ends if you switch from the screen on which AirPlay is playing to another display, such as displaying the projector's home screen.



You can use the HTTPS protocol to increase security between the projector and a Web browser communicating with it. To do this, you create a server certificate, install it on the projector, and turn on the **Secure HTTP** setting in the projector menus to verify the reliability of the Web browser.

☛ **Network > Network Settings > Projector Control > Secure HTTP**

Even if you do not install a server certificate, the projector automatically creates a self-signed certificate and allows communication. However, because the self-signed certificate cannot verify reliability from a Web browser, you see a warning about the server's reliability when you access the projector from a Web browser. This warning does not prevent communication.

#### ▶ Related Links

- "Importing a Web Server Certificate Using the Menus" [p.161](#)

## Importing a Web Server Certificate Using the Menus

You can create your Web server certificate and import it using the projector menus and an external storage device.



- You can use a USB flash drive as an external storage device for this model.
- You can also register the digital certificates from your Web browser. However, be sure to register just once or the certificate may not install correctly.

- 1** Make sure your digital certificate file is compatible with projector registration and directly placed on the USB storage device.
- 2** Press the [Menu] button, select the **Network** menu, and press [Enter].
- 3** Select **Network Settings** and press [Enter].

- 4** Select the **Projector Control** menu and press [Enter].

[ Projector Control ]		Return
Command Communication	Protected	
Web API Settings		
Basic Control	Off	<input type="checkbox"/> ↓
PJLink	Off	<input type="checkbox"/> ↓
SNMP		
AMX Device Discovery	Off	<input type="checkbox"/>
Crestron Connected	Off	<input type="checkbox"/> ↓
Crestron XiO Cloud	Off	<input type="checkbox"/>
Control4 SDDP	Off	<input type="checkbox"/>
Secure HTTP	On	<input checked="" type="checkbox"/> ↑
Web Server Certificate		

- 5** Set the **Secure HTTP** setting to **On**.
- 6** Select **Web Server Certificate** and press [Enter].
- 7** Select **Save** and press [Enter].
- 8** Follow the on-screen instructions to connect a USB storage device to the projector's USB-A port.
- 9** Press [Enter] to display the certificate list.
- 10** Select the certificate to import using the displayed list.  
A message is displayed prompting you to enter the password for the certificate.

- 11** Enter a password and press [Enter].  
The certificate is imported and a completion message appears.

► **Related Links**

- "Supported Web Server Certificates" [p.162](#)

### Supported Web Server Certificates

You can register these types of digital certificates.

#### Web Server Certificate (Secure HTTP)

Specification	Description
Format	PKCS#12
Extension	PFX, P12
Encryption	RSA
Hashes	MD5/SHA-1/SHA-256/SHA-384/SHA-512
Key length	512/1024/2048/4096 bit
Common name	Network host name
Organization	Optional
Password	Up to 64 alphanumeric characters; required

You can distribute the currently projected screen image to up to four projectors that are connected to the same network. This allows you to view the image at the same time from other projectors.

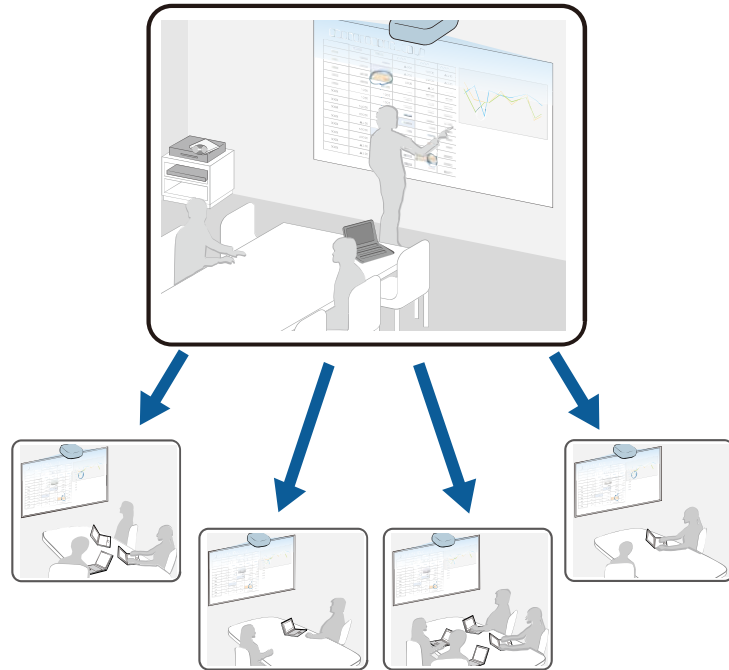

Note the following limitations when using the Screen Sharing function.

- You can share the screen with projectors that support the screen sharing feature.
- If the firmware version amongst the projectors sharing the screen is not the same, you may need to update the projector's firmware to share your screen.
- You cannot distribute images that are protected by HDCP.
- You cannot change the projector's **Network** settings during Screen Sharing.
- This function is unavailable if the input source is AirPlay, LAN or Miracast. (EB-L890E/EB-L895E/EB-L790SE/EB-L795SE/EB-L690E/EB-L890U/EB-L895U/EB-L790U/EB-L790SU/EB-L690U/EB-L690SU/EB-L695SU)

### ▶ Related Links

- "Sharing the Screen" [p.163](#)
- "Receiving Shared Screen Images" [p.165](#)

## Sharing the Screen

Before sharing the screen, you need to select settings on your projector.

- Connect the projector to the network.
- Make sure the **Screen Sharing** setting is set to **On**.
  - ☛ **Network > Network Settings > Network Projection > Screen Sharing**
- If you want to skip authentication of keywords for other projectors so you can quickly connect to them, set the **Connection Mode** setting to **Keyword Off**.
  - ☛ **Network > Network Settings > Network Projection > Screen Sharing > Connection Mode**

- 1** Turn on the projector and display an image.
- 2** Press the [Home] button.
- 3** Select **Screen Sharing**.

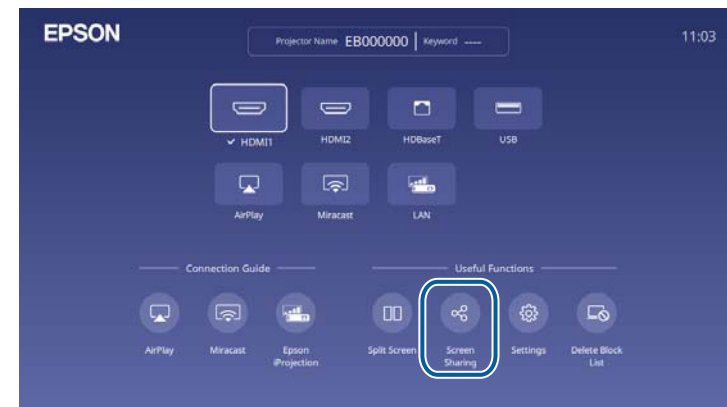

## 4 Select Start Screen Sharing.



## 5 Specify the projector you want to share your screen with.



- 1 Enter the IP address using the numeric keypad.
- 2 Enter the projector keyword using the numeric keypad, if required. The projector keyword is displayed on the projected image of the receiving projector.

- 3 Displays the connection history. To connect to a projector that you have previously connected to, select the IP address from the displayed list.

## 6 Select Connect.

When the connection is established, the bar indicating the shared status appears at the upper right of the screen. You can drag and drop the shared status bar position.

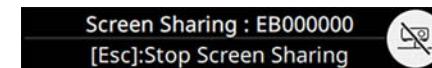

## 7 Repeat steps 3 to 6 as needed to connect to more projectors.

## 8 Select the input source to project images you want to share.

The image is distributed to the receiving projectors.

### ►► Related Links

- "Finishing the Screen Sharing" [p.164](#)

## Finishing the Screen Sharing

To finish sharing, select the  icon on the shared status bar. This option disconnects all projectors at one time. If you want to disconnect specific projector, follow the steps below.

**1** Press the [Home] button.

**2** Select **Screen Sharing**.



**3** Select the projector you want to disconnect and select **Disconnect**.



When you select **Disconnect**, the button changes to **Confirm**. Select the button again to disconnect the projector.



The selected projector is disconnected and screen sharing finishes to this projector.

**4** Repeat step 3 as needed to disconnect to more projectors.



When you select **Disconnect All**, the button changes to **Confirm**. Select the button again to disconnect all projectors.

## Receiving Shared Screen Images

Before receiving the screen, you need to select settings on your projector.

- Connect the projectors to the same network as the projector that is sharing images.
- Make sure that no other device is connecting to the projector using the Epson iProjection software.
- Make sure the **Screen Sharing** setting is set to **On**.

➡ **Network > Network Settings > Network Projection > Screen Sharing**

When the other projector starts sharing screen, the shared screen image is automatically displayed.

If not, press the [Wireless] button on the remote control.

To remove the shared image during projection, press the [Esc] button.



If you do not have the IP address for your projector, press the [Home] button and select **Screen Sharing**. You can check the IP address displayed on the guide screen.

# Monitoring and Controlling the Projector

Check these sections to monitor and control the projector over a network.

## ► Related Links

- "Epson Projector Management Connected/Epson Projector Management" [p.167](#)
- "Controlling a Networked Projector Using a Web Browser" [p.168](#)
- "Registering Digital Certificates from a Web Browser" [p.177](#)
- "Setting Up Projector Network E-Mail Alerts" [p.179](#)
- "Setting Up Monitoring Using SNMP" [p.180](#)
- "Using ESC/VP21 Commands " [p.182](#)
- "PJLink Support" [p.183](#)
- "Crestron Connected Support" [p.184](#)
- "Operating the Projector Using Web API" [p.186](#)
- "Setting Projector Event Schedules" [p.187](#)

Epson Projector Management Connected and Epson Projector Management software (Windows only) lets you monitor and control your projector over a network.

With Epson Projector Management Connected, projector information is managed on a cloud server, so it can be remotely monitored and controlled from any device.

Epson Projector Management is a Windows-only software that allows you to monitor and control projectors within the same network from your computer.

Choose one of the software programs mentioned above depending on your usage environment and purpose.

For more information, visit the following Web site.

<https://www.projection-service.epson.com/epm-connected/>



The authentication method when registering projectors varies depending on the version of the Epson Projector Management software you are using.

- Epson Projector Management Ver. 5.30 or earlier: **Monitor Password**
- Epson Projector Management Ver. 5.40 or later: **Web Control Password**

For the best results, we recommend that you use the latest version of the Epson Projector Management software.

Once you have connected your projector to your network, you can select projector settings and control projection using a compatible Web browser. This lets you access the projector remotely.

In Content Playback mode, you can also edit playlists.

### Attention

In Content Playback mode, do not remove the USB flash drive from the projector or disconnect the projector's power cord in the following situations. Data saved on the USB flash drive may be damaged.

- When the **Playlists** screen is displayed
- When the **USB Memory Device** screen is displayed



- Make sure the computer and projector are connected to the network. If you are connecting wirelessly, connect to devices over a wireless network access point.
- You can use the following Web browsers.
  - Microsoft Edge (Windows)
  - Safari (Mac, iOS)
  - Chrome (Android)
- While using the Web browser, do not connect using a proxy server. You cannot select all of the projector menu settings or control all projector functions using a Web browser.
- If you set the **Standby Mode** setting to **Normal** in the projector's **Operation** menu, you can use a Web browser to select settings and control projection even if the projector is in standby mode (when the power is off).
- You can also control the projector using a Web browser through the Epson iProjection (iOS/Android) app.

**1** Make sure the projector is turned on.

**2** Make sure your computer or device is connected to the same network as the projector.

**3** Start your Web browser on the computer or device.

**4** Go to the **Epson Web Control** screen by entering the projector's IP address into the browser's address box. When entering an IPv6 address, wrap the address with [ and ].

You see the **Epson Web Control** screen.

- In normal mode

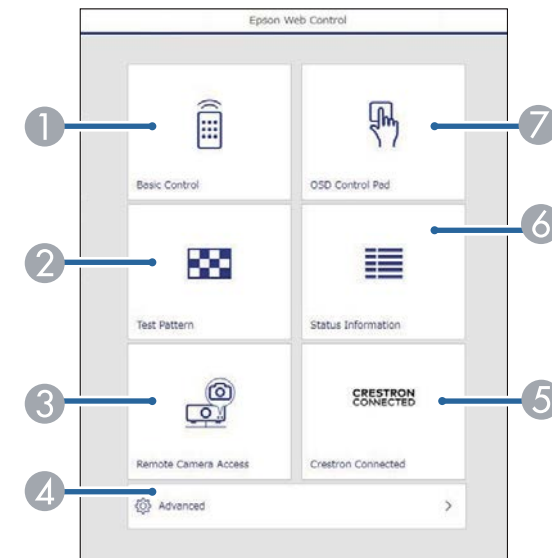

- 1** Controls the projector remotely.
- 2** Displays a test pattern.
- 3** Takes an image capture of the displayed image from a remote location. Available only when the **Remote Camera Access** menu is enabled in the projector's **Network** menu.
- 4** Sets detailed projector settings.



- ⑤ Opens the **Crestron Connected** operation window. Available only when you set the **Crestron Connected** system.
- ⑥ Displays the projector's status.
- ⑦ Operates the projector's menu settings with your finger or mouse.



You can also check the projector's log files by entering "https://<projector's IP address>/logs/" into your browser's URL bar when you set **Log Save Destination** to **USB and Internal Memory** in the projector's **Management** menu.

• In **Content Playback** mode

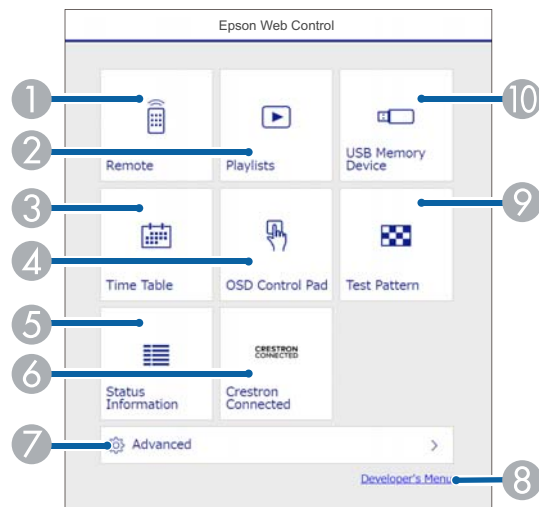

- ① Controls the projector remotely.
- ② Selects the playlist you want to play, and allows you to create or edit playlists.
- ③ Displays the **Time Table** screen.
- ④ Operates the projector's menu settings with your finger or mouse.
- ⑤ Displays the projector's status.

- ⑥ Opens the Crestron Connected operation window. Available only when you set the Crestron Connected system.
- ⑦ Sets detailed projector settings.
- ⑧ Displays the **Developer's Menu** screen.
- ⑨ Displays a test pattern.
- ⑩ Registers or deletes the data for a playlist on the USB flash drive.

**5** Select the option corresponding to the projector function you want to control.



You may need to log in to access some of the options on the **Epson Web Control** screen. Set the following passwords first.

- To access the **Basic Control** option, you need to log in using **EPSONREMOTE** as the user name and your **Remote Password**. (No password is set by default.)  
Set **Basic Control** to **On** in the projector's **Network** menu, and then set the password.  
☛ **Network > Network Settings > Projector Control > Basic Control**
- To access other options and save settings, you need to log in using **EPSONWEB** as the user name and your **Web Control Password**. (No password is set by default.)  
Set the password in the projector's **Network** menu.  
☛ **Network > Network Settings > Web Control Password**

▶▶ **Related Links**

- "Web Control Options" [p.170](#)
- "Projector Network Settings - Network Menu" [p.211](#)

## Web Control Options

### Basic Control

Options on the **Basic Control** screen allow you to select the input source and control the projector.



- If you see a log in window, enter your user name and password. (The user name is EPSONREMOTE. No password is set by default. When you are using the function for the first time, follow the on-screen instructions to set a password.)
- You can change the password in the projector's **Network** menu.
  - **Network > Network Settings > Projector Control > Basic Control**

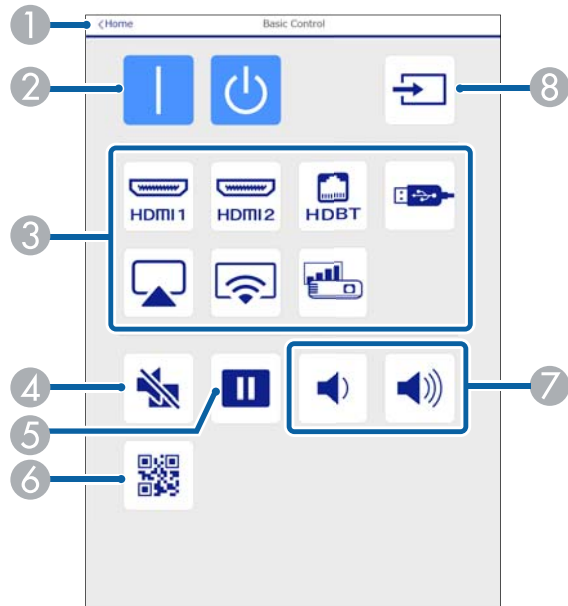

- 1 Returns to the Epson Web Control screen.
- 2 Turns the projector on or off.

- 3 Selects the input source.
- 4 Turns the video and audio on or off temporarily.
- 5 Pauses or resumes images.
- 6 Displays the QR code.
- 7 Adjusts the speaker volume.
- 8 Searches for sources.

### OSD Control Pad

Options on the **OSD Control Pad** screen allow you to display the projector's setting menus and select them moving your finger or mouse on the pad.

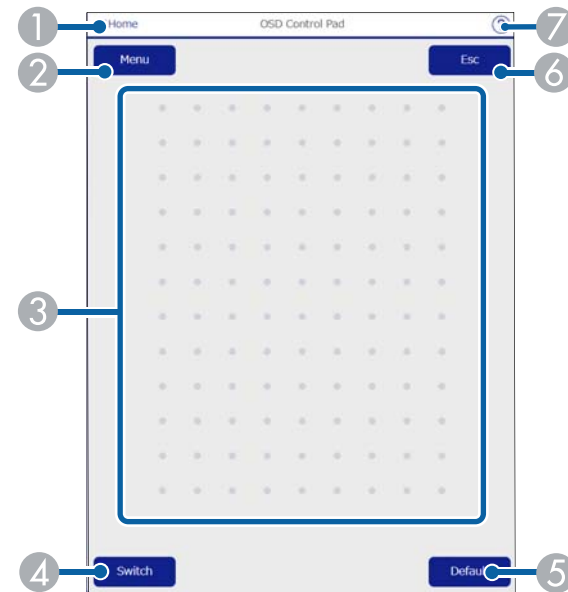

- 1 Returns to the Epson Web Control screen.
- 2 Displays the projector's setting menus.
- 3 Use your finger or mouse to navigate the menus.
- 4 Displays the button operation screen.

- 5 Resets the selected setting to its default value.
- 6 Returns to the previous menu.
- 7 Displays help topics.

## Test Pattern

The **Test Pattern** screen displays the available test patterns and allow you to select to project it.

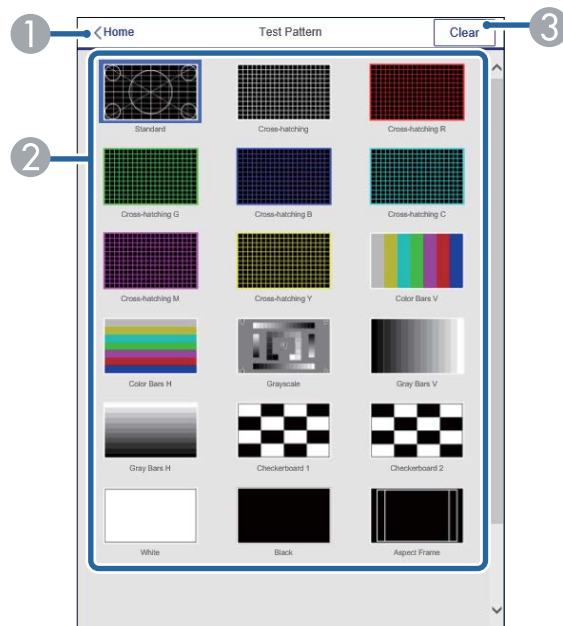

- 1 Returns to the Epson Web Control screen.
- 2 Displays available test patterns; select to project a test pattern.
- 3 Turns off test pattern display.

## Status Information



- 1 Returns to the Epson Web Control screen.
- 2 Displays a list of monitored settings.
- 3 Displays the setting status.
- 4 Select to view different status information.

## Remote Camera Access (only in normal mode)

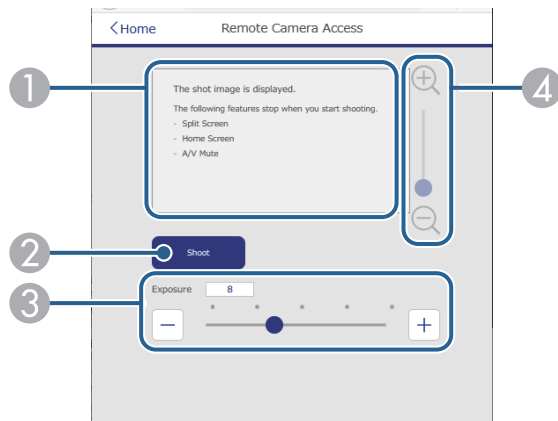

- 1 Displays the image you captured using the **Shoot** button.
- 2 Takes a picture of the projected image using the optional external camera installed on the projector.
- 3 Adjusts the image exposure.
- 4 Zooms in or out on the image you captured.

## Advanced

The **Advanced** screen allow you to select the projector's settings.

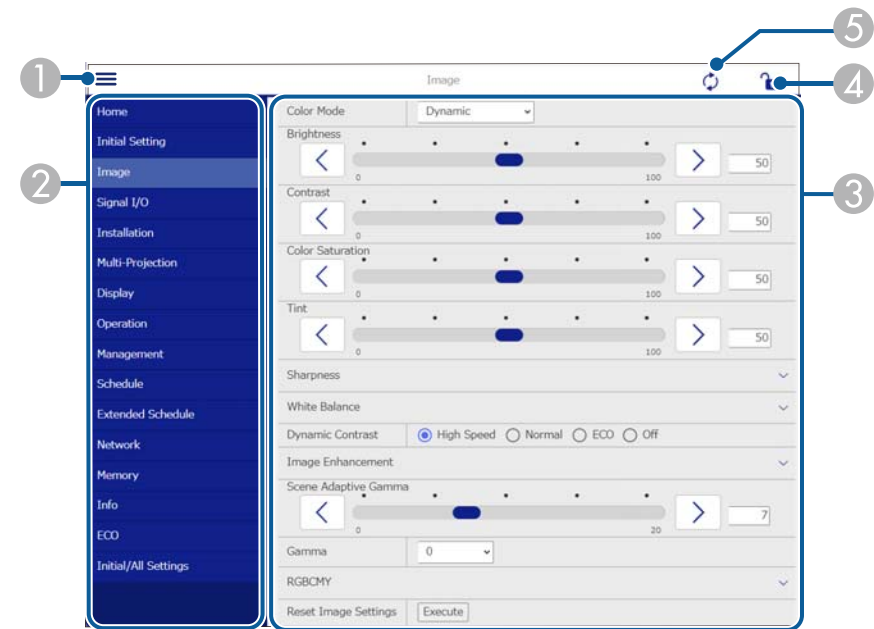

- 1 Opens the menus.
- 2 Displays the menu name you selected.
- 3 Specifies the projector settings. (The available settings vary depending on your projector model.)
- 4 Locks/unlocks the projector settings.
- 5 Updates the projector settings.



You cannot change the following settings using Epson Web Control.

- HDMI Link
- Batch Setup
- Camera Correction Assist
- Remote Camera Access
- Content Playback
- Customize Button
- User's Logo
- Wireless LAN Diagnosis
- Language
- Search Access Point
- Crestron Connected
- HDBaseT Signal Level
- Event ID
- HDBaseT Tx
- Antenna Level
- Reset Network Settings
- Firmware Update



You can select the following settings only with Epson Web Control.

- Monitor Password (up to 16 alphanumeric characters)
- IPv6 Settings (manual)
- HTTP port (port number used for Web Control except for 80 [default], 843, 3620, 3621, 3625, 3629, 4352, 4649, 5357, 10000, 10001, 41794)
- Display Logs

## Remote (only in Content Playback mode)

Options on the **Remote** screen allow you to select the input source, control the projector, and start projecting playlists.

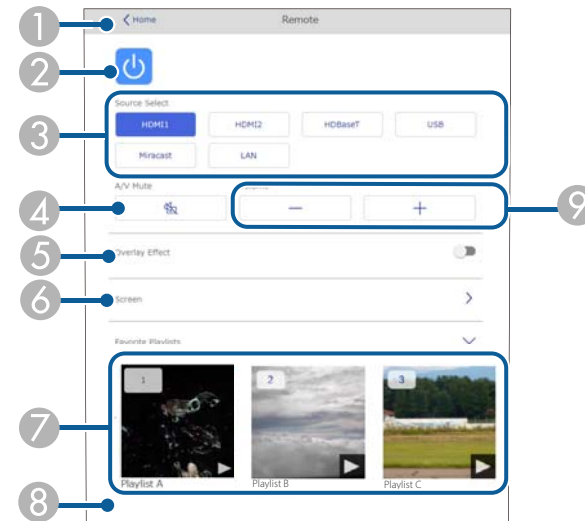

- 1 Returns to the **Epson Web Control** screen.
- 2 Turns the projector on or off.
- 3 Selects the input source. (The available sources vary depending on your projector model.)
- 4 Turns the video and audio on or off temporarily.
- 5 **Overlay Effect** option is displayed when the current source is anything other than USB.  
Turns **Overlay Effect** on or off to add color and shape effects to a playlist. When turning on, the **Effects** screen is displayed. You can add predefined color and shape effect filters to a playlist. You can also create a customized effect.
- 6 Specifies the screen settings.
- 7 Displays your favorite playlists. Select a playlist to start projecting.

- 8 Displays information for the playlist being projected.

The icons indicate the playlist settings.

: Overlay effects have been applied

: Repeat playback has been applied

: Length of the playlist

Select the arrow at the bottom-right to display the following screen.

- 9 Adjusts the speaker volume.

## Screen displayed while projecting playlist (only in Content Playback mode)

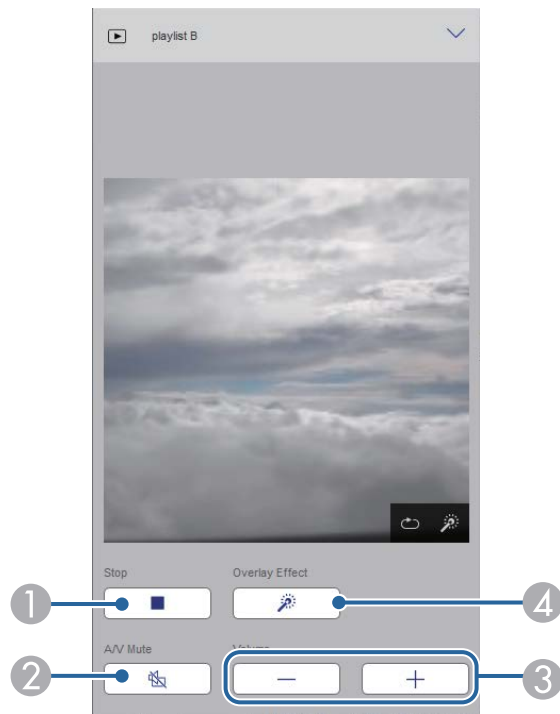

- 1 Stops projection.

- 2 Turns the video and audio on or off temporarily. However, the audio and video continue to run so you cannot resume projection at the point you activated this function.
- 3 Adjusts the speaker volume.
- 4 Opens the **Effects** screen. You can select preset effects or select individual brightness, color, and shape effect filters.

## Playlist (only in Content Playback mode)

Options on the **Playlist** screen allow you to select the playlist you want to play from the list, and create or edit playlists.

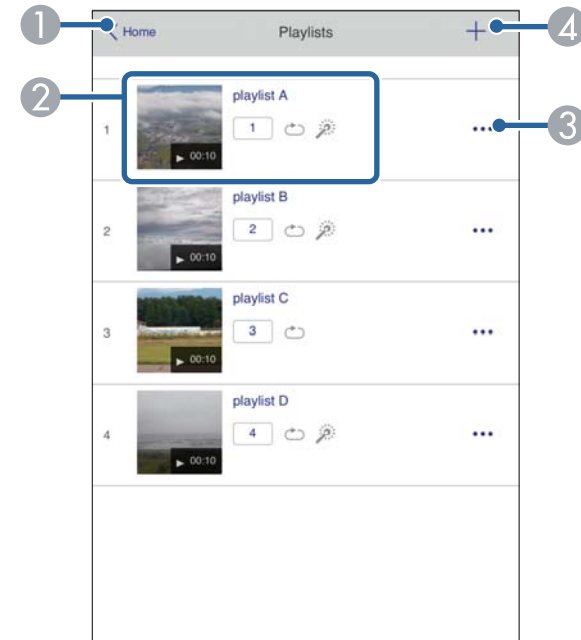

- 1 Returns to the Epson Web Control screen.

- ② Starts projecting the playlist.  
The icons indicate the playlist settings.
  - 📄: Number assigned to your favorite playlists
  - 🔄: Repeat playback has been applied
  - 🌟: Overlay effects have been applied
- ③ Opens the menu that allows you to edit, copy, register to your favorites, or delete the playlist.  
When you select **Edit** or **Duplicate**, the **Edit Playlist** screen is displayed.
- ④ Opens the **New Playlist** screen where you can create a new playlist.

- ① Edits the playlist name.
- ② Selects whether to enable repeat playback or not.
- ③ Registers the playlist as favorites.  
When registering favorites, you can quickly start playback of the favorite playlist using the **Remote** screen or the remote control.
- ④ Displays the images or movies you have added to the playlist. The playlist plays the images or movies in order.
- ⑤ Adds images or movies to the playlist.
- ⑥ Deletes images or movies from the list.
- ⑦ Opens the **Switch Image** screen.  
You can specify the time interval to switch to the next image file. You can also select a transition effect.
- ⑧ Opens the **Effects** screen.  
You can add predefined color and shape effect filters to a playlist. You can also create a customized effect.
- ⑨ Previews the playlist.

### New Playlist/Edit Playlist screen (only in Content Playback mode)

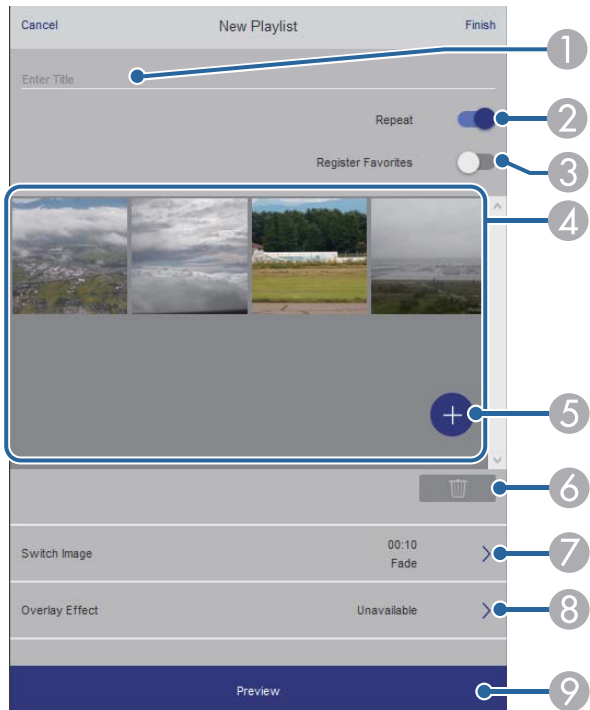

### USB Memory Device (only in Content Playback mode)

Options on the **USB Memory Device** screen allow you to upload data for a playlist to the USB flash drive or delete the data on the USB flash drive.



You can upload .avi, .jpeg (.jpg), .png, .bmp, or .gif files.  
If you want to add the .mp4 and .mov files to the playlist, use the Epson Projector Content Manager software or the Epson Creative Projection app.

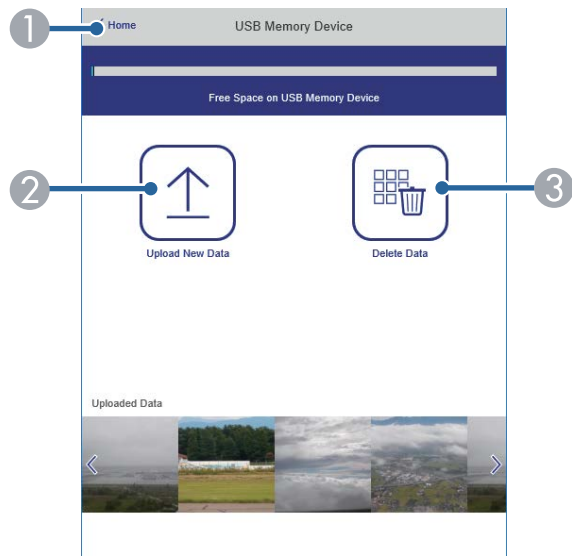

- 1 Returns to the **Epson Web Control** screen.
- 2 Copies images or movies you want to add to playlists to a USB flash drive.
- 3 Deletes images or movies on the USB flash drive.

## Time Table (only in Content Playback mode)

Options on the **Time Table** screen allow you to enable or disable the specified time table features.

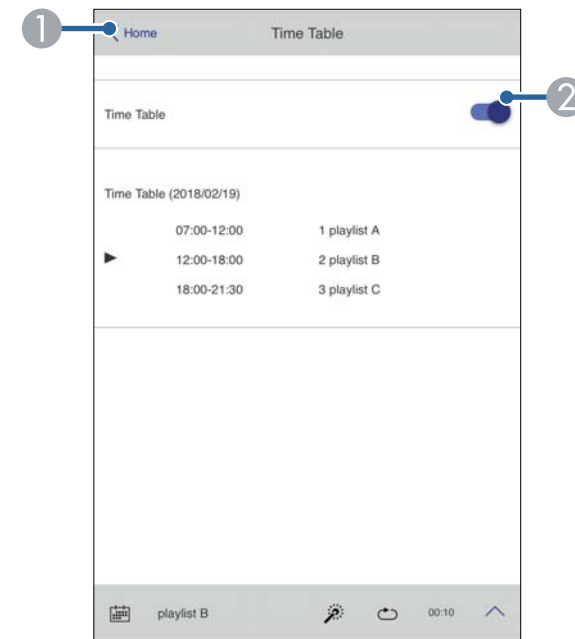

- 1 Returns to the **Epson Web Control** screen.
- 2 Turns the time table on or off.



You can specify when each playlist starts and finishes using the time table feature in the Epson Projector Content Manager software.

For details, see the *Epson Projector Content Manager Operation Guide*.



You can register the digital certificates on the projector to provide security for your presentation files.



You can also register the digital certificates in the projector's **Network** menu. However, be sure to register just once or the certificate may not install correctly.

☛ **Network > Network Configuration > Wireless LAN > EAP Method > Client Certificate**

☛ **Network > Network Configuration > Wireless LAN > EAP Method > CA certificate**

☛ **Network > Network Configuration > Others > Web Server Certificate**

- 1** Make sure your digital certificate file is compatible with projector registration.
- 2** Make sure the projector is turned on.
- 3** Start your Web browser on a computer or device connected to the network.
- 4** Go to the Epson Web Control screen by entering the projector's IP address into the browser's address box.  
You see the Epson Web Control screen.

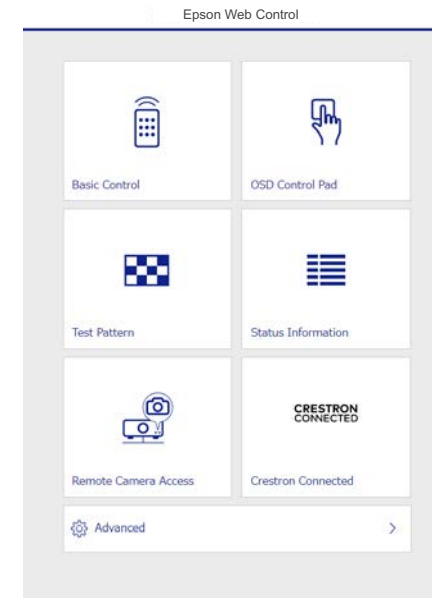

- 5** Select **Advanced**.



- You may need to log in before you see the Advanced screen. If you see a log in window, enter your user name and password. (The user name is **EPSONWEB**. No password is set by default.)
- You can change the password in the projector's **Network** menu.  
☛ **Network > Network Configuration > Basic > Web Control Password**

- 6** Under **Network**, select **Certificate**.
- 7** Select the certificate file you want to register.
- 8** Enter the password in the **Password** box, and then click **Send**.

- 9 When you finish registering the certificate, click **Apply** to finalize your changes and complete the registration.

You can set up the projector to send you an e-mail alert over the network if there is a problem with the projector.

If you set the **Standby Mode** setting to **Normal** in the projector's **Operation** menu, you can receive the e-mail alerts even if the projector is in standby mode (when the power is off).

- 1 Press the [Menu] button, select the **Network** menu, and press [Enter].
- 2 Select **Network Settings** and press [Enter].
- 3 Select the **Mail Notification** menu and press [Enter].



- 4 Set the **Mail Notification** setting to **On**.
- 5 Enter the IP address for the **SMTP Server** option.



Do not use "127.x.x.x" (where x is a number from 0 to 255) for the **SMTP Server**.

- 6 Select a type of **Authentication** of SMTP server.
- 7 Select a number for the SMTP server **Port Number**, from 1 to 65535 (default is 25).
- 8 Enter a **User Name** for the SMTP server.
- 9 Enter a **Password** for the SMTP server authentication.

- 10 Enter the e-mail address to be indicated as the sender in **From**.
- 11 Choose an address field, enter the e-mail address, and select the alerts you want to receive. Repeat for up to three addresses.



Your e-mail address can be up to 64 alphanumeric characters long.

- 12 When you finish selecting settings, go back to the **Network Settings** screen, select **Set**, and follow the on-screen instructions to save your settings and exit the menus.



If a critical problem causes a projector to shut down, you may not receive an e-mail alert.

## ▶▶ Related Links

- "Network Projector E-mail Alert Messages" [p.179](#)

---

## Network Projector E-mail Alert Messages

When a problem occurs with a projector on the network, and you selected to receive e-mail alerts, you receive an e-mail containing the following information:

- The email address set in **From** as the mail sender
- **Epson Projector** in the subject line
- The name of the projector experiencing a problem
- The IP address of the affected projector
- Detailed information about the problem

Network administrators can install SNMP (Simple Network Management Protocol) software on network computers so they can monitor projectors. If your network uses this software, you can set up the projector for SNMP monitoring.

- 1 Press the [Menu] button, select the **Network** menu, and press [Enter].
- 2 Select **Network Settings** and press [Enter].
- 3 Select the **Projector Control** menu and press [Enter].

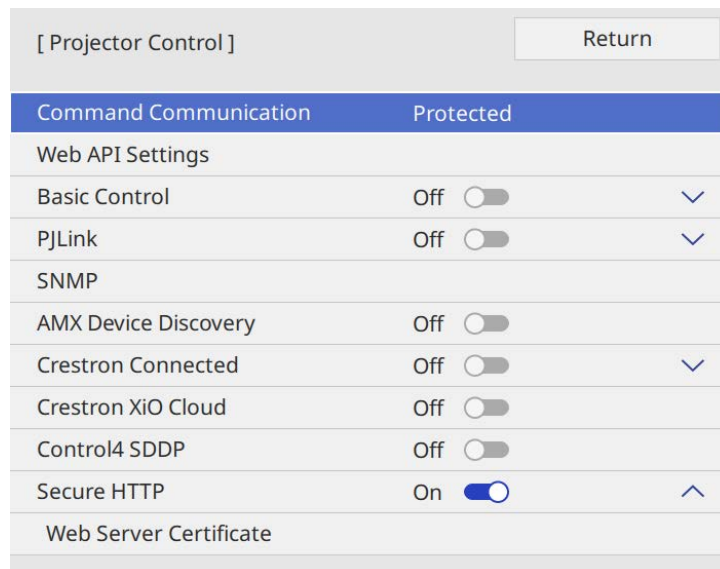

- 4 Select the **SNMP** setting and press [Enter].
- 5 Select the SNMP agent version settings to match your network settings.

- 6 Do one of the following according to the SNMP agent version you selected.
  - **SNMPv1/v2c**: Set to **On** and enter the **SNMP Community Name** up to 32 alphanumeric characters long.
  - **SNMPv3**: Set to **On** and then go to step 8.
- 7 Enter up to two IP addresses to receive SNMP notifications as the **Trap IP Address 1** and **Trap IP Address 2** settings, using 0 to 255 for each address field.



Do not use these addresses: 224.0.0.0 through 255.255.255.255.

Then go to step 9.

- 8 Select your SNMP settings as necessary.
  - **User name** lets you enter a user name using up to 32 alphanumeric characters.
  - **Trap IP Address 1** and **Trap IP Address 2** lets you enter up to two IP addresses to receive SNMP notifications, using 0 to 255 characters for each address field.



Do not use these addresses: 224.0.0.0 through 255.255.255.255.

- **Authentication** lets you select the type of SNMPv3 authentication.
- **Authentication Password** lets you enter a password for the SNMPv3 authentication using up to 32 alphanumeric characters.
- **Encryption Type** lets you select the type of SNMPv3 encryption.
- **Encryption Password** lets you enter a password for the SNMPv3 encryption using up to 32 alphanumeric characters.

- 9 When you finish selecting settings, go back to the **Network Settings** screen, select **Set**, and follow the on-screen instructions to save your settings and exit the menus.

You can control the projector from an external device using ESC/VP21.

► **Related Links**

- "ESC/VP21 Command List" [p.182](#)
- "Cable Layouts" [p.182](#)

## ESC/VP21 Command List

When the power ON command is transmitted to the projector, the power turns on and it enters warm-up mode. When the projector's power has turned on, a colon ":" (3Ah) is returned.

When a command is input, the projector executes the command and returns a ":", and then accepts the next command.

If the command being processed terminates abnormally, an error message is output and a ":" is returned.

You can check the available commands in the projector's *Specifications*.

► **Related Links**

- "Getting the Latest Version of the Documents" [p.10](#)

## Cable Layouts

### Serial connection

- Connector shape: D-Sub 9-pin (male)
- Projector input port name: RS-232C
- Cable type: Crossover (null modem) cable

In the following illustration, the projector side is shown on the left, and the computer side on the right:

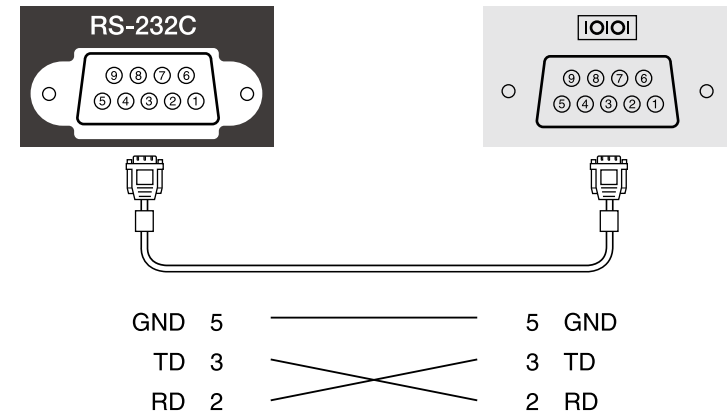

Signal name	Function
GND	Signal wire ground
TD	Transmit data
RD	Receive data

### Communications protocol

- Default baud rate setting: 9600 bps
- Data length: 8 bit
- Parity: None
- Stop-bit: 1 bit
- Flow control: None

PJLink was established by the JBMIA (Japan Business Machine and Information System Industries Association) as a standard protocol for controlling network-compatible projector's as part of their efforts to standardize projector control protocols.

The projector complies with the PJLink Class2 standard established by the JBMIA.

The port number used for the PJLink search function is 4352 (UDP).

You need to make network settings before you can use PJLink.

It complies with all commands except for the following commands defined by PJLink Class2, and agreement was confirmed by the PJLink standard adaptability verification.

<http://pjlink.jbmia.or.jp/english/>

- Non-compatible commands

Function		PJLink command
Mute settings	Image muting set	AVMT 11
	Audio muting set	AVMT 21

- Input ports and corresponding input source number

Input port name	Input source number
HDMI1	32
HDMI2	33
USB	41
LAN	52
HDBaseT	56
Miracast	57
AirPlay	59

- Manufacturer name displayed for "Manufacture name information query"  
EPSON

- Model name displayed for "Product name information query"
  - EPSON L895E/L890E
  - EPSON L795SE/L790SE
  - EPSON L790G/L695SE/L690SE
  - EPSON L690E
  - EPSON L895U/L890U
  - EPSON L790U
  - EPSON L790SU
  - EPSON L690U
  - EPSON L695SU/L690SU

▶▶ **Related Links**

- "Using the Projector on a Network" [p.138](#)

If you are using the Crestron Connected network monitoring and control system, you can set up your projector for use on the system. Crestron Connected lets you control and monitor your projector using a Web browser.



- You cannot use the Message Broadcasting feature in Epson Projector Management when you use Crestron Connected.

For additional information on Crestron Connected, visit the Crestron Web site.

<https://www.crestron.com/>

To monitor devices in the system, you can use Crestron RoomView Express or Crestron Fusion provided by Crestron. You can communicate with the help desk and send emergency messages. See the following Web site for details.

<http://www.crestron.com/getroomview>

This manual describes how to perform operations on your computer using a Web browser.

## ► Related Links

- "Setting Up Crestron Connected Support" p.184

## Setting Up Crestron Connected Support

To set up your projector for monitoring and control using a Crestron Connected system, make sure your computer and projector are connected to the network.

If you are connecting wirelessly, connect to devices over a wireless network access point.



If you set the **Standby Mode** setting to **Normal** in the projector's **Operation** menu, you can use a Web browser to select settings and control projection even if the projector is in standby mode (when the power is off).

**1** Press the [Menu] button, select the **Network** menu, and press [Enter].

**2** Select **Network Settings** and press [Enter].

**3** Select the **Projector Control** menu and press [Enter].

[ Projector Control ]		Return
Command Communication	Protected	
Web API Settings		
Basic Control	Off	<input type="checkbox"/>
PJLink	Off	<input type="checkbox"/>
SNMP		
AMX Device Discovery	Off	<input type="checkbox"/>
Crestron Connected	Off	<input type="checkbox"/>
Crestron XiO Cloud	Off	<input type="checkbox"/>
Control4 SDDP	Off	<input type="checkbox"/>
Secure HTTP	On	<input checked="" type="checkbox"/>
Web Server Certificate		

**4** Set the **Crestron Connected** setting to **On** to allow the projector to be detected.

**5** When you finish selecting settings, go back to the **Network Settings** screen, select **Set**, and follow the on-screen instructions to save your settings and exit the menus.

**6** Turn off the projector, and then turn it on again to enable the setting.

**7** Start your Web browser on a computer or device connected to the network.



- 8** Go to the Epson Web Control screen by entering the projector's IP address into the browser's address box.
- 9** Select the **Crestron Connected** settings. See the Crestron Web site for details.

You can use Web API to operate the projector in Content Playback mode and Projector Control. See the *Web API Specifications for Projectors* for details.



- You can authenticate Web API communications using API authentication (Digest authentication).
- The user name for API authentication is **EPSONWEB**; use the password that is set for **Web Control Password**.
  - ☛ **Network > Network Settings > Web Control Password**

## ▶▶ Related Links

- "Enabling Web API" [p.186](#)

---

## Enabling Web API

You can enable Web API from a Web browser.

- 1** Select **Developer's Menu** on the Epson Web Control screen.
- 2** Set **Enable API** to **On**.

You can schedule up to 30 events to occur automatically on your projector, such as turning the projector on or off or switching the input source. The projector performs the selected events on the specified date and time in the schedule you set up.

## Warning

Do not place flammable objects in front of the lens. If you schedule the projector to turn on automatically, flammable objects in front of the lens could catch on a fire.



- If you set a **Menu Protection of Schedule** to **On**, turn it off first.

- 1** Set the date and time in the **Date & Time** menu in the projector's **Management** menu.
- 2** Press the [Menu] button, select the **Management** menu, and press [Enter].
- 3** Select **Schedule Settings** and press [Enter].
- 4** Select **Schedule** and press [Enter].

- 5** Select **Add New** and press [Enter].

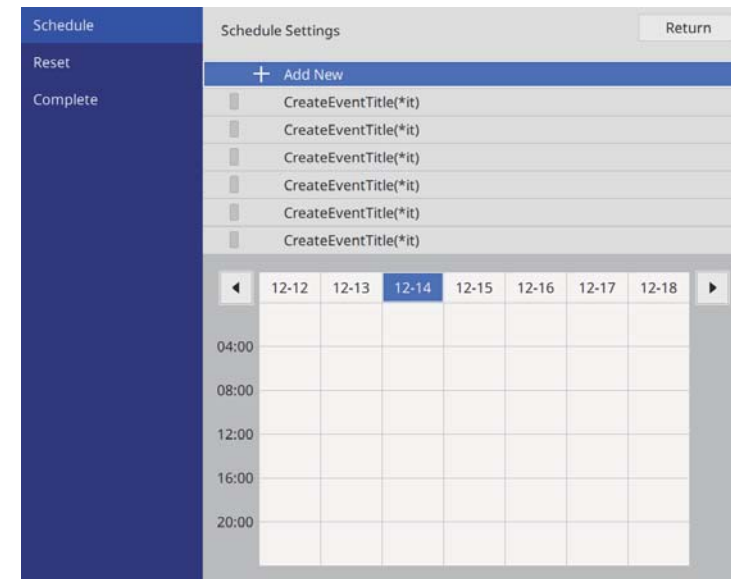

**6** Select the event details you want to perform.

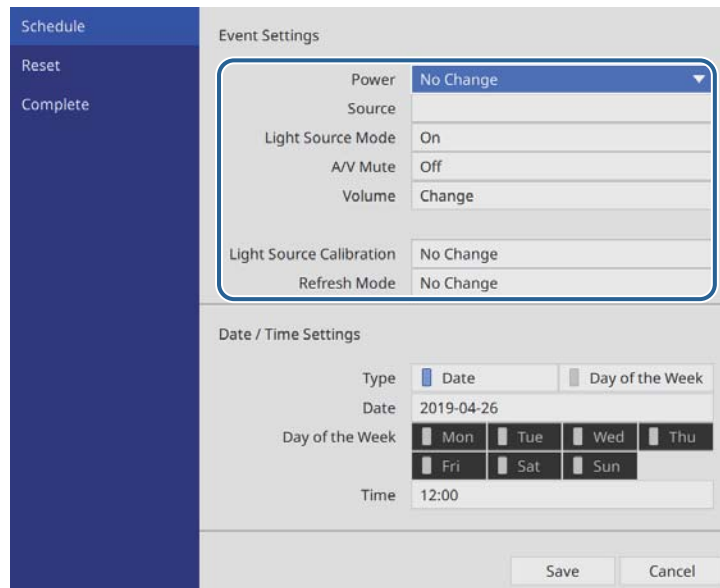

**7** Select the date and time at which you want the event to occur.

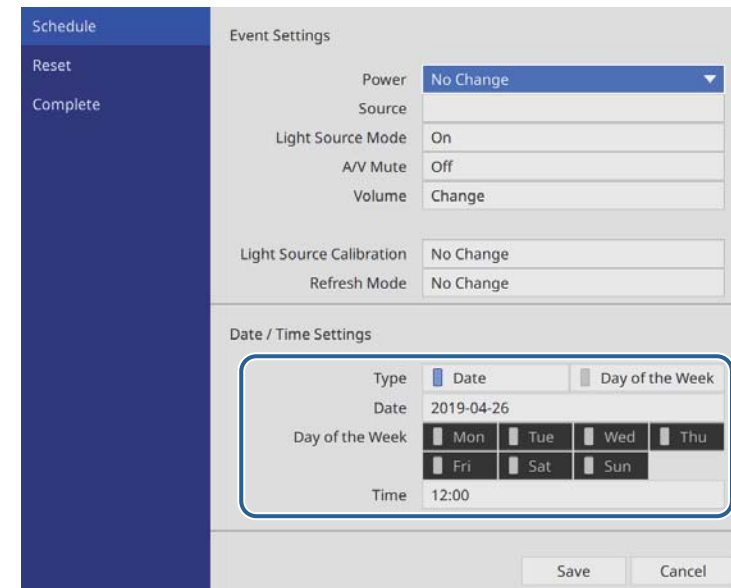

**8** Select **Save** and press [Enter].  
The scheduled events are displayed on the screen with icons indicating the event status.

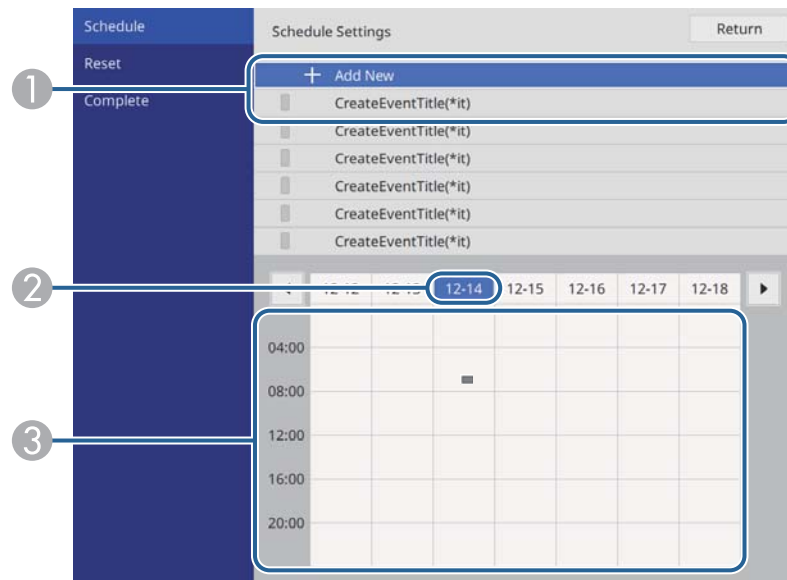

- **Edit** lets you change the event details or date and time.
- **Clear** lets you remove the scheduled event from a list.

**11** Select **Setup complete**, then select **Yes**.

To delete all scheduled events, select **Schedule Reset**.

**▶▶ Related Links**

- "Setting the Date and Time" [p.51](#)
- "Projector Administration Settings - Management Menu" [p.207](#)

- 1 : valid schedule
- : regular schedule
- : invalid schedule
- 2 The date currently selected (highlighted)
- 3 : one time schedule
- : regular schedule
- : standby schedule (turns communication on or off during standby)
- : invalid schedule

**9** To edit a scheduled event, select the schedule and press [Esc].

**10** Select an option from the menu displayed.

- **On** or **Off** lets you enable or disable the selected event.

# Adjusting the Menu Settings

Follow the instructions in these sections to access the projector menu system and change projector settings.

## ► Related Links

- ["Using the Projector's Menus" p.191](#)
- ["Using the Displayed Keyboard" p.192](#)
- ["Image Quality Settings - Image Menu" p.193](#)
- ["Input Signal Settings - Signal I/O Menu" p.196](#)
- ["Projector Installation Settings - Installation Menu" p.198](#)
- ["Multiple Projector Operation Settings - Multi-Projection Menu" p.200](#)
- ["Projector Display Settings - Display Menu" p.202](#)
- ["Projector Feature Settings - Operation Menu" p.204](#)
- ["Projector Administration Settings - Management Menu" p.207](#)
- ["Projector Network Settings - Network Menu" p.211](#)
- ["Projector Information Display - Info Menu" p.222](#)
- ["Image Quality Memory Settings - Memory Menu" p.223](#)
- ["Projector Setup Settings - ECO Menu" p.224](#)
- ["Projector Initial Settings and Reset Options - Initial/All Settings Menu" p.225](#)
- ["Copying Menu Settings Between Projectors \(Batch Setup\)" p.227](#)



You can use the projector's menus to adjust the settings that control how your projector works. The projector displays the menus on the screen.

- 1 Press the [Menu] button on the control panel or remote control.  
You see the menu screen.

Image	Color Mode	Dynamic
Signal I/O	Image Adjustment	☀ 50 ● 50 ● 50 ● 50
Installation	Sharpness	
Multi-Projection	White Balance	
Display	Dynamic Contrast	Off
Operation	Image Enhancement	
Management	Scene Adaptive Gamma	0
Network	Gamma	
Info	RGBCMY	
Memory	Reset to Defaults	
ECO	Aspect	Auto
Initial/All Settings	Scale	
	Reset Image Settings	

- 2 Press the up or down arrow buttons to move through the menus listed on the left. The settings for each menu are displayed on the right.
- 3 To change settings in the displayed menu, press [Enter].
- 4 Press the up or down arrow button to move through the settings.
- 5 To return all the menu settings to their default values, select **Initial/All Settings**.
- 6 When you finish changing settings on a menu, press [Esc].

- 7 Press [Menu] or [Esc] to exit the menus.

 The  arrow indicates that the menu contains sub items. When you turn on a menu setting or select a specific value for it, the menu system displays the sub items.



You can use the displayed keyboard to enter numbers and characters.

- 1 Use the arrow buttons on the control panel or remote control to highlight the number or character you want to enter and press the [Enter] button.

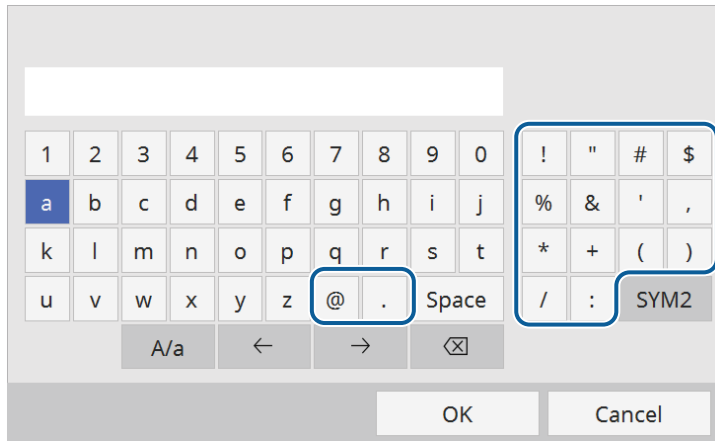

Each time you select the A/a key, the characters change between upper case and lower case. Each time you select the SYM1/2 key, the symbols enclosed by the frame change.

- 2 After entering the text, select **OK** on the keyboard to confirm your entries. Select **Cancel** to cancel entering text.



You can select projector settings and control projection over a network using a Web browser from your computer.  
Some symbols cannot be entered using the displayed keyboard. Use your Web browser to enter the text.

► **Related Links**

- "Available Text Using the Displayed Keyboard" [p.192](#)

## Available Text Using the Displayed Keyboard

You can enter the following text when using the displayed keyboard.

Text type	Details
Numbers	0123456789
Alphabet	ABCDEFGHIJKLMNOPQRSTUVWXYZ abcdefghijklmnopqrstuvwxyz
Symbols	!"#\$%&'()*+,-./:;<=>?@[ \ ] ^ _`{ }~



Settings on the **Image** menu let you adjust the quality of your image. The available settings depend on the currently selected color mode and input source.

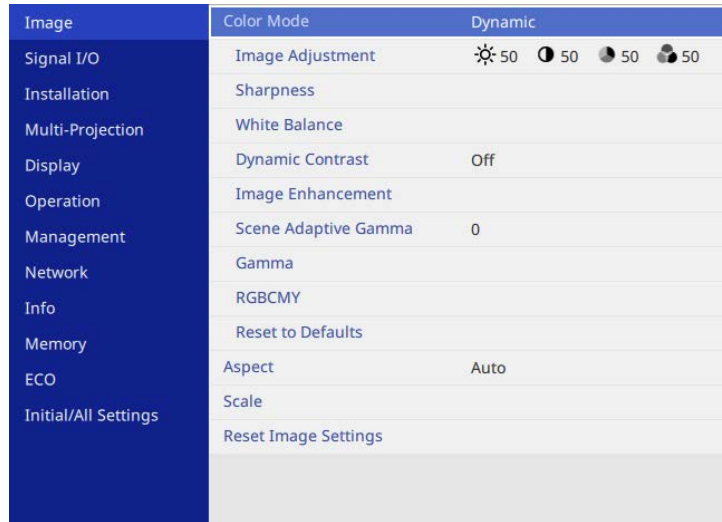

Setting	Options	Description
Color Mode	See the list of available color modes	Adjusts the vividness of image colors for various image types and environments.
Image Adjustment	Brightness	Lightens or darkens the overall image.
	Contrast	Adjusts the difference between light and dark areas of the image.
	Color Saturation	Adjusts the intensity of the image colors.
	Tint	Adjusts the balance of green to magenta tones in the image.
Sharpness	Various levels available	Adjusts the sharpness or softness of image details.

Setting	Options	Description
White Balance	Color Temp.	Sets the color temperature according to the color mode you selected. Higher values tint the image blue and lower values tint the image red.  Setting is only displayed when <b>Color Filter</b> is not set to <b>Warm White</b> or <b>Cool White</b> .  🖱️ <b>Operation &gt; Content Playback &gt; Overlay Effect &gt; Color Filter</b>
	G-M Correction	Makes fine adjustments to the color tone. Higher values tint the image green and lower values tint the image red.
	Custom	Adjusts the individual R (red), G (green), and B (blue) components of the offset and gain.
Dynamic Contrast	High Speed Normal ECO Off	Adjusts the projected luminance based on the image brightness.
Image Enhancement	4K Enhancement	(This setting may be unavailable depending on your projector model.) You can project an image at a doubled resolution by diagonally shifting 1 pixel in increments of 0.5 pixels. A highresolution image signal is projected in fine detail. This item is disabled in the following cases: <ul style="list-style-type: none"> <li>• The <b>Aspect</b> setting is set to <b>Native</b></li> <li>• You are using the <b>Screen Sharing</b> function</li> </ul>

Setting	Options	Description
	Image Preset Mode	Selects the settings prepared in advance as the settings for <b>Noise Reduction</b> , <b>MPEG Noise Reduction</b> , and <b>Detail Enhancement</b> .
	Noise Reduction	Reduces flickering in analog images. This item is disabled in the following cases: <ul style="list-style-type: none"> <li>• When using one of the following input sources (Available input sources differ depending on your projector model.)                             <ul style="list-style-type: none"> <li>• USB</li> <li>• LAN</li> <li>• AirPlay</li> <li>• Miracast</li> </ul> </li> <li>• An image that exceeds 2k resolution is being input</li> <li>• An interlaced signal is being input</li> <li>• <b>4K Enhancement</b> is set to <b>On</b></li> <li>• <b>Edge Blending</b> is set to <b>Blending/Black Level</b> or <b>Black Level</b></li> </ul>
	MPEG Noise Reduction	Reduces the noise or artifacts seen in MPEG video. This setting is unavailable when using one of the following input sources: <ul style="list-style-type: none"> <li>• USB</li> <li>• LAN</li> </ul>
	Detail Enhancement	Creates a more emphatic texture and material feel of the image.
	Reset	Resets all adjustment values on the <b>Image Enhancement</b> setting to their default settings.

Setting	Options	Description
Scene Adaptive Gamma	Various levels available	Adjusts the coloring according to the scene, and obtains a more vivid image. Select a large number to enhance contrast.
Gamma	-5 to 5 Custom	Adjusts the coloring by selecting one of the gamma correction values, or referring to a gamma graph.
RGBCMY	Various levels available	Adjusts the hue, saturation, and brightness of each color <b>R</b> (red), <b>G</b> (green), <b>B</b> (blue), <b>C</b> (cyan), <b>M</b> (magenta), <b>Y</b> (yellow) individually.
Reset to Defaults	—	Resets all settings for the current color mode.
Aspect	See the list of available aspect ratios	Sets the aspect ratio (width-to-height ratio) for the selected input source. (Turn off the <b>Scale</b> setting or set the <b>Scale Mode</b> setting to <b>Full Display</b> first.) This setting is only displayed when the current source is HDMI, HDBaseT, or USB while projecting images viewed by the document camera.
Scale	Various scale options	Enlarges or reduces the image horizontally and vertically. Adjusts the scale of the image displayed by each projector when using multiple projectors to project one image.
Reset Image Settings	—	Resets all adjustment values on the <b>Image</b> menu to their default settings.



- The **Brightness** setting does not affect light source brightness. To change the light source brightness, select the **Light Source Brightness Control** setting in the projector's **Operation** menu.

### ▶ **Related Links**

- "Available Color Modes" [p.82](#)
- "List of Functions" [p.11](#)

Normally the projector automatically detects and optimizes the input signal settings. If you need to customize the settings, you can use the **Signal I/O** menu. The available settings depend on the currently selected input source.

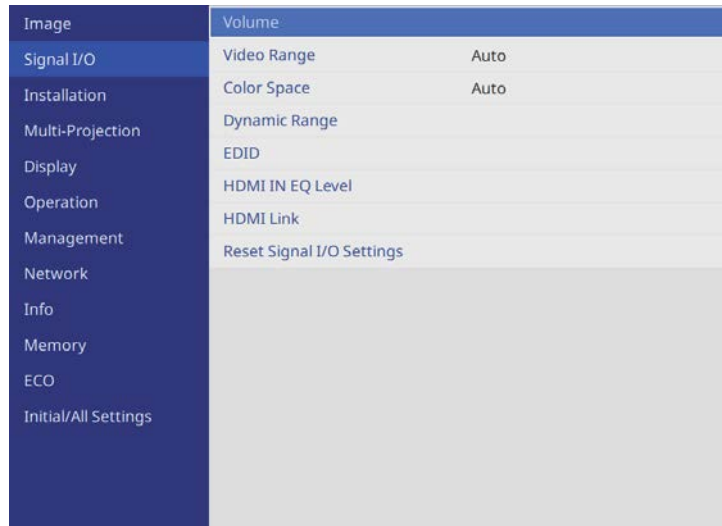

Setting	Options	Description
Volume	Various levels available for each source	Adjusts the volume of projector's speaker system. You can also adjust the volume of external speakers. Setting is only displayed when the audio is not output to AV system.
Video Range	Auto Limited (16-235) Full (0-255)	Sets the video range to match the setting of input source.

Setting	Options	Description
Color Space	Auto BT.709 BT.2020	Sets the conversion system for the color space. You cannot select this setting when <b>Color Mode</b> is set to <b>BT.709</b> or <b>DICOM SIM</b> in the projector's <b>Image</b> menu.
Dynamic Range	Dynamic Range	Changes the range of dark and bright areas in images; choose from <b>Auto</b> (recommended), <b>SDR</b> , <b>HDR10</b> or <b>HLG</b> . You cannot select this setting when <b>Color Mode</b> is set to <b>BT.709</b> or <b>DICOM SIM</b> in the projector's <b>Image</b> menu.
	Signal Status	Displays the detected input image signal.
	HDR10 Setting	Changes the PQ (Perceptual Quantizer) curve of the dynamic range using the HDR PQ method. This setting is only displayed when <b>Dynamic Range</b> is set to <b>Auto</b> and <b>Signal Status</b> is set to <b>HDR10</b> , or when <b>Dynamic Range</b> is set to <b>HDR10</b> .
	HLG Setting	Changes the HLG (Hybrid Log Gamma) curve of the dynamic range using the HDR HLG method. This setting is only displayed when <b>Dynamic Range</b> is set to <b>Auto</b> and <b>Signal Status</b> is set to <b>HLG</b> , or when <b>Dynamic Range</b> is set to <b>HLG</b> .

Setting	Options	Description
EDID	EDID (HDMI1) EDID (HDMI2) EDID (HDBaseT)	Describes the display capabilities of your projector. Change this setting as necessary according to the resolution of the image.  Even in setups with multiple displays with different resolutions, you can switch the <b>EDID</b> of the current source and unify the <b>EDID</b> across the displays by setting the same <b>EDID</b> as the standard display.
HDMI IN EQ Level	HDMI1 HDMI2	Adjusts the HDMI input signal level depending on the devices connected to the HDMI port. If there is a lot of interference in the image, or if a problem such as no image being projected occurs, change the setting.  You can select the settings for individual input sources without changing the input source.
HDMI Link	HDMI Link	Set to <b>On</b> to enable the <b>HDMI Link</b> features.
	Device Connections	Lists the devices connected to the HDMI ports.  Setting is only displayed when <b>HDMI Link</b> is set to <b>On</b> .
	Audio Out Device	Selects whether to output audio from the internal speakers or a connected audio/video system.

Setting	Options	Description
	Power On Link	Controls what happens when you turn on the projector or connected device.  This setting is not available when <b>HDMI Out Power Link</b> is set to <b>On</b> .  <ul style="list-style-type: none"> <li>• <b>Bidirectional</b>: automatically turns on the connected device when you turn on the projector, and vice versa.</li> <li>• <b>Device -&gt; PJ</b>: automatically turns on the projector when you turn on the connected device.</li> <li>• <b>PJ -&gt; Device</b>: automatically turns on the connected device when you turn on the projector.</li> </ul>
	Power Off Link	Controls whether connected devices are turned off when you turn off the projector.  This setting is not available when <b>HDMI Out Power Link</b> is set to <b>On</b> .
	HDMI Out Power Link	Turns on or off devices connected to the HDMI Out port when you turn the projector on or off.
	HDMI Out Terminal End	Set to <b>On</b> only for the projector at the end of the daisy chain.  This setting is not available when <b>HDMI Out Power Link</b> is set to <b>Off</b> .
Reset Signal I/O Settings	—	Resets all adjustment values on the <b>Signal I/O</b> menu to their default settings.

Settings on the **Installation** menu help you set up your projector in your installation environment.

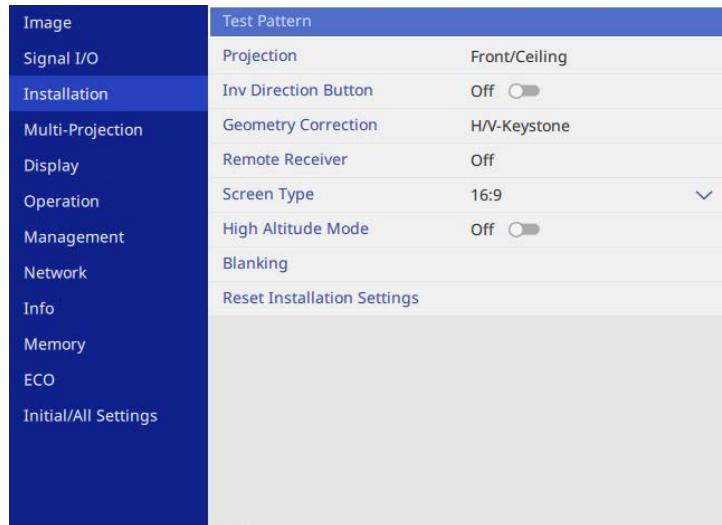

Setting	Options	Description
Geometry Correction	H/V-Keystone	Manually corrects horizontal and vertical sides. <b>V-Keystone:</b> lets you manually correct vertical side. <b>V-Balance:</b> lets you manually correct vertical balance. <b>H-Keystone:</b> lets you manually correct horizontal side. <b>H-Balance:</b> lets you manually correct horizontal balance.
	Quick Corner	Corrects image shape and alignment using an on-screen display.
	Point Correction Mode	Divides the projected image into a grid and corrects the distortion by moving the selected point of intersection from side to side and up and down.
	Curved Surface Mode	Corrects the corners and sides of an image projected on a curved surface.
	Corner Wall Mode	Corrects the corners and sides of an image projected on a curved surface with right angles.
	Off	Temporarily cancels the geometry correction.

Setting	Options	Description
Test Pattern	—	Displays a test pattern to assist in focusing and zooming the image and correcting image shape (press the [Esc] button to cancel pattern display).
Projection	Front Rear Front/Ceiling Rear/Ceiling	Sets the way the projector faces the screen so the image is oriented correctly.
Inv Direction Button	On Off	When suspending the projector from a ceiling, set to <b>On</b> to invert the operation direction of the control panel arrow buttons.

Setting	Options	Description
	Memory	<p>Save customized sets of settings to memory.</p> <ul style="list-style-type: none"> <li>• <b>Save Memory:</b> saves the current shape of an image you have adjusted.</li> <li>• <b>Load Memory:</b> loads the settings you made and saved.</li> <li>• <b>Rename Memory:</b> changes the name of the memory settings.</li> <li>• <b>Erase Memory:</b> deletes a saved memory.</li> <li>• <b>Reset Memory:</b> resets all saved memories.</li> </ul>
Remote Receiver	Front/Rear Front Rear Off	Limits reception of remote control signals by the selected receiver; <b>Off</b> turns off all receivers.
Screen Type	4:3 16:6 16:9 16:10 21:9	<p>Sets the aspect ratio of the screen to fit the image into the projection area.</p> <p>Setting is only displayed when <b>Content Playback</b> is set to <b>Off</b> in the projector's <b>Operation</b> menu.</p>
Screen Position	Various positions available	<p>Shifts the image position horizontally and vertically.</p> <p>This feature is not available if you set the <b>Screen Type</b> setting to the same aspect ratio as the projector resolution.</p>
High Altitude Mode	On Off	Regulates the projector's operating temperature at altitudes above 1,500 m.

Setting	Options	Description
Blanking	Top Bottom Left Right	<p>Hides an area of the projected image that you select using the arrow buttons.</p> <p>Setting is only displayed when <b>Content Playback</b> is set to <b>Off</b> in the projector's <b>Operation</b> menu.</p>
Reset Installation Settings	—	Resets all adjustment values on the <b>Installation</b> menu to their default settings.

Settings on the **Multi-Projection** menu let you set up multiple projectors to project a single unified image.

Image	Projector ID	Off
Signal I/O	Batch Setup	
Installation	Group Tiling	
Multi-Projection	Geometry Correction	H/V-Keystone
Display	Edge Blending	
Operation	Black Level	
Management	Scale	
Network	Screen Matching	
Info	Color Uniformity	
Memory	Light Source Mode	Normal
ECO	Color Matching	
Initial/All Settings	RGBCMY	
	Camera Correction Assist	
	Reset Multi-Projection Sett...	

Setting	Options	Description
Edge Blending	Edge Blending Top Edge Bottom Edge Left Edge Right Edge Line Guide Pattern Guide Guide Color	Blends the border between multiple images to create a seamless screen.
Black Level	Color Adjustment Area Correction Reset	Adjusts the black color of the overlapping image area. You cannot select this setting when <b>Blending</b> is set to <b>On</b> for the <b>Top Edge</b> , <b>Bottom Edge</b> , <b>Left Edge</b> , or <b>Right Edge</b> setting.
Scale	—	See the <b>Image</b> menu table for details on the <b>Scale</b> settings.

Setting	Options	Description
Projector ID	Off 1 through 9	Assigns an ID for the projector when you use multiple projectors.
Batch Setup	—	Performs batch settings necessary to use the Multi-Projection features.
Group Tiling	Projector Grouping	Creates a group of projectors that you can control simultaneously.
	Tiling	Sets the number of split screens and the position of each image.
Geometry Correction	—	See the <b>Installation</b> menu table for details on the <b>Geometry Correction</b> settings.



Setting	Options	Description
Screen Matching	Start Auto Adjustment Undo Redo Schedule Settings Color Mode Light Source Brightness Control Color Matching Color Uniformity Black Level Reset	<p>You can adjust the tint, brightness, black level, and blend curve of multiple projectors so that they match better.</p> <ul style="list-style-type: none"> <li>The auto adjustment feature is only available under the following conditions.                             <ul style="list-style-type: none"> <li>When you set the position of each image using <b>Location Setup</b> in the <b>Tiling</b> menu</li> <li>When an optional camera is installed</li> <li>When <b>Color Calibration</b> in the projector's <b>Management</b> menu is set to <b>On</b></li> </ul> </li> <li>You can undo or redo the screen matching procedure only when <b>Light Source Mode</b> is set to <b>Custom</b>.</li> </ul>
Color Uniformity	Color Uniformity	Set to <b>On</b> to adjust the color tone balance for the whole screen.
	Adjustment Level	Sets the adjustment level.
	Start Adjustments	Adjusts the red, green, and blue color tones individually for the selected area.
	Reset	Resets all adjustment values on the <b>Color Uniformity</b> menu to their default settings.

Setting	Options	Description
Light Source Mode	Normal Quiet Extended Custom	<p>Select the brightness for the light source.</p> <p>This setting is not available when <b>Maintain Brightness</b> is set to <b>On</b> in the projector's <b>Operation</b> menu.</p> <ul style="list-style-type: none"> <li><b>Normal</b>: maximum brightness.</li> <li><b>Quiet</b>: 70% brightness with reduced fan noise.</li> <li><b>Extended</b>: 70% brightness and extends the life expectancy of the light source.</li> <li><b>Custom</b>: select a custom brightness level.</li> </ul>
Color Matching	Adjustment Level Red Green Blue Brightness	Corrects the difference between the tint and brightness of each projected image.
RGBCMY	—	See the <b>Image</b> menu table for details on the <b>RGBCMY</b> settings.
Camera Correction Assist	Simple Stacking	Creates a bright projected image by overlapping the images from two projectors.
	Simple Blending	Creates one large image by compositing several images from two projectors.
Reset Multi-Projection Settings	—	Resets all adjustment values on the <b>Multi-Projection</b> menu to their default settings.

Settings on the **Display** menu let you customize various projector display features.

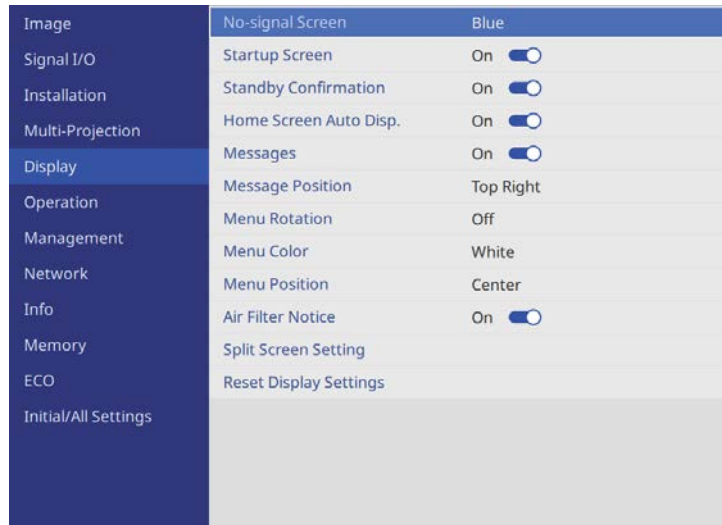

Setting	Options	Description
No-signal Screen	Black Blue Logo	Sets the screen color or logo to display when no signal is received.  Setting is only displayed when <b>Content Playback</b> is set to <b>Off</b> in the projector's <b>Operation</b> menu.
Startup Screen	On Off	Set to <b>On</b> to display a logo when the projector starts up.
Standby Confirmation	On Off	Set to <b>On</b> to display a confirmation message after pressing the power button on the remote control.
Home Screen Auto Disp.	On Off	Set to <b>On</b> to display the Home screen automatically when there is no input signal when turning on the projector.

Setting	Options	Description
Messages	On Off	Set to <b>On</b> to display messages such as input source name, color mode name, aspect ratio, no signal message, or high temperature warning on your projected image.
Message Position	Top Right Right Bottom Right Bottom Bottom Left Left Top Left Top Center	Selects the position of the projector menu displayed on the screen.
Menu Rotation	Right 90 Degree Left 90 Degree Off	Rotates the menu display 90°.
Menu Color	Black White	Sets the color theme of the Home screen and projector menu system.
Menu Position	Center Top Right Right Bottom Right Bottom Bottom Left Left Top Left Top	Selects the position of menu displayed on the screen.
Air Filter Notice	On Off	Set to <b>On</b> to display a message when a clog in the air filter is detected.

Setting	Options	Description
Split Screen Setting	Display Audio Output Source	Set to <b>On</b> to display an icon with the source providing audio output during split screen projection.  Setting is only displayed when <b>Content Playback</b> is set to <b>Off</b> in the projector's <b>Operation</b> menu.
	Align	If you have split two screen images, select the position of the images to be aligned at the <b>Top</b> or <b>Middle</b> of the image area.  Setting is only displayed when <b>Content Playback</b> is set to <b>Off</b> in the projector's <b>Operation</b> menu.
Reset Display Settings	—	Resets all adjustment values on the <b>Display</b> menu to their default settings.



If you turn on **Menu Protection** of **User's Logo**, you cannot change the following user's logo display settings; you must turn off **Menu Protection** of **User's Logo** first.

- No-signal Screen
- Startup Screen

▶▶ **Related Links**

- "Projecting Two Images Simultaneously" [p.96](#)

Settings on the **Operation** menu let you customize various projector features.

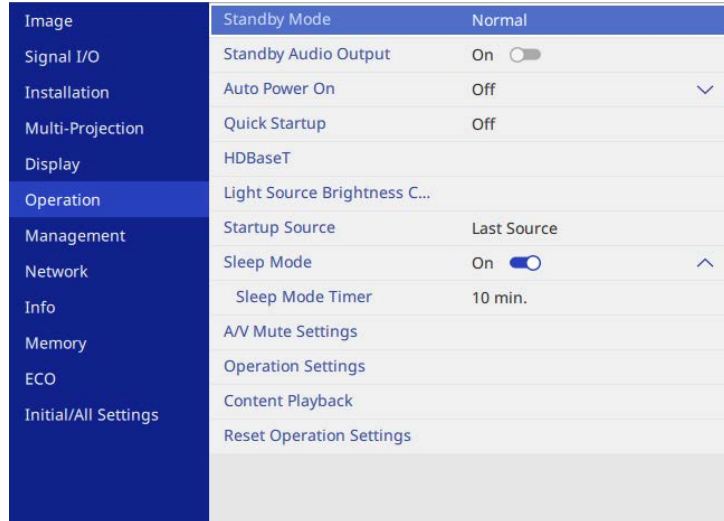

Setting	Options	Description
Standby Mode	ECO Wired LAN Communication Normal	<p>Sets the operation status when the projector is in standby mode.</p> <ul style="list-style-type: none"> <li>• <b>ECO:</b> disables network communication and reduces standby power to the minimum.</li> <li>• <b>Wired LAN Communication:</b> enables wired network communication even when no images are being projected and reduces standby power.</li> <li>• <b>Normal:</b> enables network communication and USB power supply even when no images are being projected.</li> </ul> <p>Setting is only displayed in the following cases:</p> <ul style="list-style-type: none"> <li>• <b>Auto Power On</b> is set to <b>Off</b></li> <li>• <b>Quick Startup</b> is set to <b>Off</b></li> </ul>
Standby Audio Output	On Off	<p>Sets whether or not to output audio when no image is being projected.</p> <p>Setting is only displayed in the following cases:</p> <ul style="list-style-type: none"> <li>• <b>Standby Mode</b> is set to <b>Normal</b></li> <li>• <b>Auto Power On</b> is set to <b>Off</b></li> <li>• <b>Quick Startup</b> is set to <b>Off</b></li> </ul>
Auto Power On	Off HDMI1 HDBaseT	<p>Sets the image source from which you want to automatically start projection.</p> <p>When the projector detects the input signal from the selected image source, it projects automatically in standby mode.</p>

Setting	Options	Description
Quick Startup	Off	Sets the time period for Quick Startup mode. The projector enters this mode when you turn it off. You can start projecting in approximately 5 seconds by pressing the power button.  However, it may take longer to become ready for use in the following situations: <ul style="list-style-type: none"> <li>When projecting from the projector's USB port</li> <li>When projecting using the Miracast features</li> </ul> Setting is only displayed in the following cases: <ul style="list-style-type: none"> <li><b>Auto Power On</b> is set to <b>Off</b>.</li> </ul>
	60min. 90min.	
HDBaseT	Control Communications	Enables or disables communication from the Ethernet and serial ports on the HDBaseT transmitter or switcher; turning on this setting disables the projector's LAN and RS-232C ports. Setting is only displayed when <b>Extron XTP</b> is set to <b>Off</b> .
	Extron XTP	Set to <b>On</b> when you connect an Extron XTP transmitter or switcher to the HDBaseT ports. See the following Extron Web site for more details on the XTP system. <a href="http://www.extron.com/">http://www.extron.com/</a>
Light Source Brightness Control	Maintain Brightness	Set to <b>On</b> to maintain a constant brightness for the light source.
	Maintain Brightness Level	Select the brightness level you want to maintain constantly.  Setting is only displayed when <b>Maintain Brightness</b> is set to <b>On</b> .

Setting	Options	Description
	Light Source Mode	See the <b>Multi-Projection</b> menu table for details on the <b>Light Source Mode</b> settings.  Setting is only displayed when <b>Maintain Brightness</b> is set to <b>Off</b> .
	Brightness Level	Select the brightness level you want when <b>Custom</b> is set to <b>Light Source Mode</b> .  Setting is only displayed when <b>Maintain Brightness</b> is set to <b>Off</b> .
Auto Source Search	On Off	Set to <b>On</b> to detect the input signal automatically and project images when there is no input signal.  This function is disabled when you turn on the projector in the <b>Quick Startup</b> mode.  Setting is only displayed when <b>Content Playback</b> is set to <b>Off</b> .
Startup Source	Various input sources available	Select the image source you want to project when the projector is turned on in Content Playback mode.
Sleep Mode	On Off	Set to <b>On</b> to automatically turns off the projector after an interval of inactivity.
Sleep Mode Timer	15 seconds to 30 minutes	Sets the interval for <b>Sleep Mode</b> .
A/V Mute Settings	A/V Mute Timer	Turns off the projector automatically if <b>A/V Mute</b> is enabled and 30 minutes of inactivity has passed.
	Button to Release A/V Mute	Select <b>A/V Mute</b> if you want to use only the [A/V Mute] button to turn off A/V Mute, or select <b>Any Button</b> to use any button to turn it off.

Setting	Options	Description
Operation Settings	Direct Power On	Set to <b>On</b> to turn on the projector by plugging it in without pressing the power button.
	Indicators	Set to <b>Off</b> to turn off the indicator lights on the projector except when an error or warning occurs.
	Beep	Controls the beep that sounds when you turn the projector on or off.
	Log Save Destination	Sets the location in which to save error and operation log files. Setting is only displayed when <b>Content Playback</b> is set to <b>Off</b> .
	Batch Setup Range	Select <b>All</b> to copy all of the projector menu settings using the batch setup feature. Select <b>Limited</b> , if you do not want to copy the following settings: <ul style="list-style-type: none"> <li>• <b>Password Protection</b> settings</li> <li>• <b>EDID</b> in the <b>Signal I/O</b> menu</li> <li>• <b>Network</b> menu settings</li> </ul>
Content Playback	On Off	Set to <b>On</b> to play back a playlist.
Overlay Effect	Overlay Effect Shape Filter Color Filter Lightness	Adds color and shape effects to the projected image. Setting is only displayed in the following cases: <ul style="list-style-type: none"> <li>• <b>Edge Blending</b> is set to <b>Off</b> in the projector's <b>Multi-Projection</b> menu.</li> <li>• In Content Playback mode, the playlist can be played and no writable error has occurred.</li> </ul>
USB Viewer	—	Selects and plays back a playlist saved on the USB flash drive.

Setting	Options	Description
Reset Operation Settings	—	Resets all adjustment values on the <b>Operation</b> menu to their default settings.

► **Related Links**

- "Functions Available in Standby Mode" [p.206](#)
- "Adjusting the Brightness" [p.89](#)
- "Projecting in Content Playback Mode" [p.104](#)

## Functions Available in Standby Mode

The following table shows the combination of the **Standby Mode** settings and available functions.

	Function						
	Auto Power On	Quick Startup	Audio Output	USB power supply	Wireless LAN	Wired LAN	AirPlay
ECO	—	—	—	—	—	—	—
Wired LAN Communication	—	—	—	—	—	✓ *1	—
Normal	✓*2	✓*2	✓*2	✓*1	✓*1	✓*1	✓*1

\*1: This function's availability depends on the Standby Mode setting.

\*2: To use this function, you must also enable it in the setting for each function.

Settings on the **Management** menu let you customize various projector administrative features.

Image	Customize Button	Not Set
Signal I/O	User's Logo	
Installation	Control Panel Lock	Off
Multi-Projection	Color Uniformity	
Display	Refresh Mode	
Operation	Light Source Calibration	
<b>Management</b>	Color Calibration	
Network	Date & Time	
Info	Schedule Settings	
Memory	NFC Settings	
ECO	Language	English
Initial/All Settings	Reset Management Settings	

Setting	Options	Description
Control Panel Lock	Full Lock Except for Power Off	Controls projector button locking to secure the projector: <ul style="list-style-type: none"> <li>• <b>Full Lock:</b> locks all buttons.</li> <li>• <b>Except for Power:</b> locks all buttons except the power button.</li> <li>• <b>Off:</b> no buttons locked.</li> </ul>
Color Uniformity	—	See the <b>Multi-Projection</b> menu table for details on the <b>Color Uniformity</b> settings.
Refresh Mode	Timer	Sets a time period during which the projector displays the refresh image.
	Messages	Set to <b>On</b> to display a message informing you that the projector is in refresh mode.
	Start	Starts the refresh mode process to clear any projected afterimage and turn off the projector after a specified period of time. Press any button on the remote control to cancel this process.
Light Source Calibration	Run Now	Starts light source calibration to optimize the white balance of the currently projected image. You may not be able to start calibration if the projector's environmental temperature is out of range. (Wait 30 minutes after turning on the projector before starting calibration for the best results.)
	Run Periodically	Set to <b>On</b> to perform light source calibration periodically every 100 hours of usage.
	Last Run	Displays the date and time of the last light source calibration.

Setting	Options	Description
Customize Button	Various menu options available	Assigns a menu option to the [Customize] button on the remote control for one-touch access.
User's Logo	Start Setting Reset	Creates a screen that the projector displays to identify itself and enhance security.  This setting is unavailable when <b>Test Pattern</b> is set to <b>Captured Image</b> in the projector's <b>Installation</b> menu.

Setting	Options	Description
Color Calibration	Color Calibration	The color calibration process adjusts the color balance and brightness that has deteriorated over time based on images taken by the optional external camera, and restores the default image quality. Set to <b>On</b> to enable the color calibration process. You need to connect the optional external camera for the color calibration process.
	Start Auto Adjustment	Starts auto adjustment.
	Undo	You can undo auto adjustment.
	Redo	Select after selecting <b>Undo</b> to restore the image to the status after auto adjustment.
	Color Uniformity	You can adjust the color tone balance for the whole image.
	Reset	You can reset all adjustment values on the Color Calibration menu to their default settings.
Date & Time	Date & Time Daylight Saving Time Internet Time	Adjusts the projector's system time and date settings. Select <b>Daylight Saving Time</b> to set daylight saving time settings for your region. Select <b>Internet Time</b> to automatically acquire the time from an Internet time server.
Schedule Settings	—	Schedules projector events to occur automatically at selected dates and times.

Setting	Options	Description
NFC Settings	NFC Write Protection NFC Write Password	Prevents scanning the projector's settings. <ul style="list-style-type: none"> <li>• <b>NFC Write Protection:</b> prevents anyone from scanning the projector's settings.</li> <li>• <b>NFC Write Password:</b> you can set a password for scanning the projector's settings using up to 32 alphanumeric characters.</li> </ul>
Language	Various languages available	Select the language for projector menu and message displays.
Reset Management Settings	—	Resets all adjustment values on the <b>Management</b> menu to their default settings, except for the following: <ul style="list-style-type: none"> <li>• <b>Date &amp; Time</b></li> <li>• <b>Language</b></li> </ul>



When you set **Menu Protection** of **Schedule** to **On**, you cannot change settings on the **Schedule Settings**. Set **Menu Protection** of **Schedule** to **Off** first.

### ►► Related Links

- "Event ID Code List" [p.208](#)

## Event ID Code List

If the **Event ID** option on the **Information** screen displays a code number, check this list of Event ID codes for the solution to the projector problem associated with the code.

If you cannot resolve the problem, contact your network administrator or Epson for technical support.



Event ID code	Cause and solution
0432 0435	The network software did not start. Turn the projector off and then on again.
0433	Cannot display the transferred images. Restart the network software.
0434 0481 0482 0485	Unstable network communication. Check the network communication status, wait a few moments, and try connecting to the network again.
0483 04FE	The network software quit unexpectedly. Check the network communication status, then turn the projector off and then on again.
0484	Communication with computer was disconnected. Restart the network software.
0479 04FF	A projector system error has occurred. Turn the projector off and then on again.
0523	When attempting to connect using Miracast, the WPS connection timed out. Move the projector and mobile device closer together and try connecting again.
0524	When attempting to connect using Miracast, an unknown error occurred during the WPS process between the projector and mobile device. Set <b>Miracast</b> to <b>Off</b> in <b>Network Projection</b> from the <b>Network Settings</b> menu, then set it back to <b>On</b> , and restart the projector.
0525	When attempting to connect using Miracast, the security settings between the projector and mobile device do not match. Set <b>Miracast</b> to <b>Off</b> in <b>Network Projection</b> from the <b>Network Settings</b> menu, then set it back to <b>On</b> , and restart the projector.
0526	When attempting to connect using Miracast, the WPA2 handshake was not completed correctly. Set <b>Miracast</b> to <b>Off</b> in <b>Network Projection</b> from the <b>Network Settings</b> menu, then set it back to <b>On</b> , and restart the projector.

Event ID code	Cause and solution
0527	When attempting to connect using Miracast, the WPA2 four-way handshake failed, and the connection could not be established. Set <b>Miracast</b> to <b>Off</b> in <b>Network Projection</b> from the <b>Network Settings</b> menu, then set it back to <b>On</b> , and restart the projector.
0528	After connecting using Miracast, IP address acquisition failed, or the projector was unable to provide a valid IP address. Set <b>Miracast</b> to <b>Off</b> in <b>Network Projection</b> from the <b>Network Settings</b> menu, then set it back to <b>On</b> , and restart the projector.
0529	Miracast control communication (RTSP message exchange) failed. Disconnect the Miracast connection and then reconnect.
0530	When attempting to connect using Miracast, video or audio streaming could not be performed correctly. Move the projector and mobile device closer together and try connecting again.
0532	When attempting to connect using Miracast, there is a video or audio codec incompatibility between the mobile device and projector, such as differences in H.264/H.265, or an unsupported format is being used. Check if the resolution and codec settings on the mobile device are compatible with Miracast specifications.
0535	The Miracast session ended unexpectedly. Restart the projector and mobile device and try connecting again.
0536	When attempting to connect using Miracast, an unexpected communication disconnection occurred, such as an application crash. Restart the projector and try connecting using Miracast again.
0542	When attempting to connect using Miracast, an unknown P2P connection error occurred. Restart the projector and mobile device and try connecting again.
0543	When attempting to connect using Miracast, a video format error occurred. You cannot project using the projector due to an unsupported resolution or frame rate. Check if your mobile device is compatible with Miracast specifications.

Event ID code	Cause and solution
0544	The mobile device you tried to connect to the projector using Miracast is on the block list, and the connection has been denied. Remove the device from the block list and try connecting again.
0891	Cannot find an access point with the same SSID. Set your computer, access point, and projector to the same SSID.
0892	The WPA/WPA2/WPA3 authentication type does not match. Make sure the wireless network security settings are correct.
0893	The TKIP/AES encryption type does not match. Make sure the wireless network security settings are correct.
0894	Communication with an unauthorized access point was disconnected. Contact your network administrator.
0895	Communication with a connected device was disconnected. Check your device connection status.
0898	Failed to acquire DHCP. Make sure the DHCP server is operating correctly. If you are not using DHCP, set the DHCP setting to <b>Off</b> in the projector's <b>Network</b> menu. <ul style="list-style-type: none"> <li>☛ <b>Network &gt; Network Settings &gt; Wired LAN &gt; IP Settings &gt; DHCP</b></li> <li>☛ <b>Network &gt; Network Settings &gt; Wireless LAN &gt; IP Settings &gt; DHCP</b></li> </ul>
0899	Other communication errors.
089A	The EAP authentication type does not match the network. Check the wireless LAN security settings and make sure that the security certificate is installed correctly.
089B	EAP server authentication failed. Check the wireless LAN security settings and make sure that the security certificate is installed correctly.
089C	EAP client authentication failed. Check the wireless LAN security settings and make sure that the security certificate is installed correctly.

Event ID code	Cause and solution
089D	Key exchange failed. Check the wireless LAN security settings and make sure that the security certificate is installed correctly.

Settings on the **Network** menu let you view network information and set up the projector for controlling over a network.

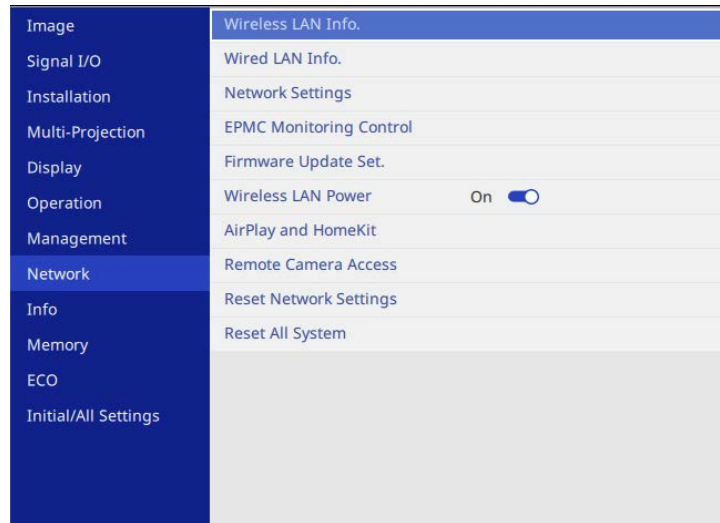

When you set **Menu Protection** of **Network** to **On**, you cannot change the network settings. Set **Menu Protection** of **Network** to **Off** first.

Setting	Options	Description
Wireless LAN Info.	Wireless LAN Info.	Displays wireless network status and details.
Wired LAN Info.	Wired LAN Info.	Displays wired network status and details.
Network Settings	—	Configures your projector network settings. See the network menu table for details on the <b>Network Settings</b> . Not available when the source is AirPlay.

Setting	Options	Description
EPMC Monitoring Control	EPMC Settings Export EPMC Settings Import EPMC Settings	Set to <b>On</b> and make the necessary settings to directly communicate with the Epson Projector Management Connected cloud server, not through the Epson Projector Connected Agent. See the <i>Epson Projector Management Connected Operation Guide</i> for more details. <a href="https://www.projection-service.epson.com/pages/epm-connected/online-manual/web-front/EN/index.html">https://www.projection-service.epson.com/pages/epm-connected/online-manual/web-front/EN/index.html</a>
Firmware Update Set.	Notify Do not notify Auto update at midnight Off	(This setting may be unavailable depending on your projector model.) Set whether to send a notification containing projector firmware update information, and whether to automatically update the firmware. We recommend setting it to <b>Off</b> when you are using the Epson Projector Management Connected software.
Wireless LAN Power	On Off	Set to <b>On</b> to project images via a wireless LAN. If you do not want to connect via wireless LAN, turn it <b>Off</b> to prevent unauthorized access by others.
Wireless LAN Diagnosis	Ping IP Address Ping until stopped Start	(This setting may be unavailable depending on your projector model.) Transmits Ping to confirm communication status.
AirPlay and HomeKit	—	Displays the AirPlay and HomeKit settings screen. Not available when the source is AirPlay.
Remote Camera Access	Remote Camera Access	You can display the image taken by the optional external camera using Epson Web Control.

Setting	Options	Description
Reset Network Settings	—	Resets all adjustment values on the <b>Network</b> menu to their default settings. Not available when the source is AirPlay.  <div style="border: 1px solid black; padding: 5px; background-color: #ffffcc;"> <p><b>Attention</b></p> <p>All of the passwords that have been set for the <b>Network</b> menu are also reset and you need to set them again. To prevent the passwords from being reset by unauthorized users, set <b>Network</b> to <b>On</b> in the <b>Menu Protection</b> menu.</p> </div>
Reset All System	—	Resets the projector's network firmware. Not available when the source is AirPlay.  <div style="border: 1px solid black; padding: 5px; background-color: #ffffcc;"> <p><b>Attention</b></p> <p>All of the passwords that have been set for the <b>Network</b> menu are also reset and you need to set them again. To prevent the passwords from being reset by unauthorized users, set <b>Network</b> to <b>On</b> in the <b>Menu Protection</b> menu.</p> </div>

 Once you have connected your projector to your network, you can select projector settings and control projection using a compatible Web browser. This allows you to access the projector remotely.

► **Related Links**

- "Network Menu - Network Settings Menu" [p.212](#)
- "List of Functions" [p.11](#)

- "Controlling a Networked Projector Using a Web Browser" [p.168](#)

## Network Menu - Network Settings Menu

Settings on the **Network Settings** menu let you select the basic network settings.



- If you are connecting via wireless LAN, make sure the followings to enable wireless LAN settings:
  - Check that the wireless LAN module is built in, or install the wireless LAN module on your projector.
  - Turn on the **Wireless LAN Power** setting in the projector's **Network** menu.
- If the **Web Control Password** has not been set, a screen prompting you to set a password is displayed before you can save network settings. Follow the on-screen instructions to set the password.

Setting	Options	Description
Projector Name	Up to 16 alphanumeric characters (do not use " * + , / : ; < = > ? [ \ ] `   spaces)	Enter a name to identify the projector over the network.
Web Control Password	8 to 32 alphanumeric characters (do not use * : spaces)	Enter a password for accessing the projector over the Web. (The user name is EPSONWEB. No password is set by default.)
Priority Control Interface	Wired LAN Wireless LAN	Sets the priority gateway.

Setting	Options	Description
Proxy	IP Address Port Number	(This setting may be unavailable depending on your projector model.) Enter the <b>IP Address</b> and <b>Port Number</b> of the proxy server.
IPv6	On Off	(This setting may be unavailable depending on your projector model.) Set to <b>On</b> if you want to connect the projector to the network using IPv6. IPv6 is supported to monitor and control the projector over a network using Epson Web Control and PjLink.
Simple AP	On Off	Set to <b>On</b> to enable simple access point mode for direct connection between your projector and input devices. Make sure you are also doing the following: <ul style="list-style-type: none"> <li>• Using <b>Quick Connection Mode</b> of Epson iProjection</li> <li>• Using Miracast connection</li> </ul> Setting is only displayed when <b>Wireless LAN Power</b> is set to <b>On</b> in the projector's <b>Network</b> menu.
SSID	Automatically assigned SSID	Displays the SSID of the projector for selection on your device in simple AP connections. You cannot select this setting when <b>Simple AP</b> is set to <b>Off</b> .
Security	WPA2-PSK	Displays the security type for simple AP connections. You cannot select this setting when <b>Simple AP</b> is set to <b>Off</b> .

Setting	Options	Description
Passphrase	Various passphrases from 8 to 63 characters	Enter the passphrase of the projector for entry on your device in simple AP connections. You cannot select this setting when <b>Simple AP</b> is set to <b>Off</b> .
Wireless LAN system	802.11ac (Wi-Fi 5) 802.11n (Wi-Fi 4)	(This setting may be unavailable depending on your projector model.) Sets the communication method between the projector and the mobile device. The available methods vary depending on countries, regions, and your projector model. You cannot select this setting when <b>Simple AP</b> is set to <b>Off</b> .
Channel	Various channels available	Sets the frequency band (channel) used in simple AP connections. You cannot select this setting when <b>Simple AP</b> is set to <b>Off</b> .
Wireless LAN	—	See the <b>Wireless LAN</b> menu table for details.
Wired LAN	—	See the <b>Wired LAN</b> menu table for details.
Mail Notification	—	See the <b>Mail Notification</b> menu table for details.
Projector Control	—	See the <b>Projector Control</b> menu table for details.
Network Projection	—	See the <b>Network Projection</b> menu table for details.

▶▶ **Related Links**

- "Network Menu - Wireless LAN Menu" [p.214](#)
- "Network Menu - Wired LAN Menu" [p.216](#)

- "Network Menu - Mail Notification Menu" p.216
- "Network Menu - Projector Control Menu" p.217
- "Network Menu - Network Projection Settings" p.219

## Network Menu - Wireless LAN Menu

Settings on the **Wireless LAN** menu let you select the wireless LAN settings.



- Turn on the **Wireless LAN Power** setting in the projector's **Network** menu.
- If you did not install an optional wireless LAN module, turn off the **Simple AP** setting to enable you to select wireless LAN settings.
- If you have installed the optional wireless LAN module, turn on the **Simple AP** setting to enable you to select wireless LAN settings.

When connecting to a wireless network, it is strongly recommended that you set security. When setting security, follow the instructions from the administrator of the network system you want to connect to.

WPA is an encryption standard that improves the security for wireless networks. The projector supports AES encryption methods.



WPA2/WPA3-EAP and WPA3-EAP do not support WPA3 192-bit security.

Setting	Options	Description
Search Access Point	To Search View	Search for available wireless network access points. Depending on the access point settings, they may not be displayed in the list.
SSID	Up to 32 alphanumeric characters	Enter the SSID (network name) of the wireless LAN system the projector is connecting to.

Setting	Options	Description
Security	WPA2/WPA3-PSK	Connects in WPA2/WPA3 personal mode. Encryption method is selected automatically according to the access point settings. Set a passphrase which is the same for the access point.
	WPA2/WPA3-EAP	Connects in WPA2/WPA3 enterprise mode. Encryption method is selected automatically according to the access point settings.
	WPA3-PSK	Connects in WPA3 personal mode. Communication is performed using WPA3 security. Uses AES method for encryption. When establishing a connection from a computer to the projector, enter the value set in the passphrase.
	WPA3-EAP	Connects in WPA3 enterprise mode. Encryption method is selected automatically according to the access point settings.
	Open	Security is not set.
Passphrase (For WPA2/WPA3-PSK and WPA3-PSK security)	Various passphrases from 8 to 63 characters	Enter the pre-shared passphrase used on the network.  When the passphrase is entered and the [Enter] button is pressed, the value is set and displayed as an asterisk (*).  We recommend changing the passphrase periodically for security. If the network settings are initialized, it returns to the initial passphrase.
EAP Type (For WPA2/WPA3-EAP and WPA3-EAP security)	PEAP	Authentication protocol widely used in Windows Server.
	EAP-TLS	Authentication protocol widely used to use a client certificate.

Setting	Options	Description
User name	Up to 64 alphanumeric characters	Enter a user name for the network. To include a domain name, add it before a backslash and the user name (domain\username).  When importing a client certificate, the name the certificate was issued to is automatically set.
Password	Up to 64 alphanumeric characters	Enter a password for authentication. After you enter the password and select <b>Set</b> , the password is displayed as an asterisk (*).  Setting is only displayed when <b>EAP Type</b> is set to <b>PEAP</b> .
Client Certificate	—	Imports the client certificate.  Setting is only displayed when <b>EAP Type</b> is set to <b>EAP-TLS</b> .
CA certificate	—	Imports the CA certificate.
RADIUS Server Name	Up to 64 alphanumeric characters	Enter the server name to verify.
IP Settings	DHCP IP Address Subnet Mask Gateway Address	Set <b>DHCP</b> to <b>On</b> if your network assigns addresses automatically; set to <b>Off</b> to manually enter the network's <b>IP Address</b> , <b>Subnet Mask</b> , and <b>Gateway Address</b> using 0 to 255 for each address field.  Do not use these addresses: 0.0.0.0, 127.x.x.x, 192.0.2.x, 192.168.48.x, 192.168.88.x or 224.0.0.0 through 255.255.255.255 (where x is a number from 0 to 255) for IP Address, 255.255.255.255 or 0.0.0.0 through 254.255.255.255 for Subnet Mask, and 0.0.0.0, 127.x.x.x or 224.0.0.0 through 255.255.255.255 for Gateway Address.

Setting	Options	Description
DNS Server 1 DNS Server 2	Various IP addresses	Enter the IP address for the DNS server, using 0 to 255 for each address field. The DNS server resolves the host name. Do not use the following IP addresses: 127.x.x.x (where x is a number from 0 to 255).  When these settings are not set and remain as 0.0.0.0, DNS server information is acquired using DHCP. After acquiring the information, the values remain as 0.0.0.0.
IPv6	On Off	(This setting may be unavailable depending on your projector model.)  Set to <b>On</b> if you want to connect the projector to the network using IPv6. IPv6 is supported to monitor and control the projector over a network using Epson Web Control and PjLink.
Auto Configuration	On Off	(This setting may be unavailable depending on your projector model.)  Set to <b>On</b> to assign addresses automatically according to the Router Advertisement.
Use Temporary Address	On Off	(This setting may be unavailable depending on your projector model.)  Set to <b>On</b> if you want to use a temporary IPv6 address.
IP Address Display	On Off	Set to <b>On</b> to display the IP address on the network information screen and Home screen.

►► **Related Links**

- "List of Functions" [p.11](#)

## Network Menu - Wired LAN Menu

Settings on the **Wired LAN** menu let you select the wired LAN settings.

Setting	Options	Description
IP Settings	DHCP IP Address Subnet Mask Gateway Address	Set <b>DHCP</b> to <b>On</b> if your network assigns addresses automatically; set to <b>Off</b> to manually enter the network's <b>IP Address</b> , <b>Subnet Mask</b> , and <b>Gateway Address</b> using 0 to 255 for each address field.  Do not use these addresses: 0.0.0.0, 127.x.x.x, 192.0.2.x, 192.168.48.x, 192.168.88.x, or 224.0.0.0 through 255.255.255.255 (where x is a number from 0 to 255) for <b>IP Address</b> , 255.255.255.255 or 0.0.0.0 through 254.255.255.255 for <b>Subnet Mask</b> , and 0.0.0.0, 127.x.x.x or 224.0.0.0 through 255.255.255.255 for <b>Gateway Address</b> .
DNS Server 1 DNS Server 2	Various IP addresses	Enter the IP address for the DNS server, using 0 to 255 for each address field. The DNS server resolves the host name. You cannot use the following IP addresses: 127.x.x.x (where x is a number from 0 to 255).  When these settings are not set and remain as 0.0.0.0, DNS server information is acquired using DHCP. After acquiring the information, the values remain as 0.0.0.0.

Setting	Options	Description
IPv6	On Off	(This setting may be unavailable depending on your projector model.) Set to <b>On</b> if you want to connect the projector to the network using IPv6.  IPv6 is supported to monitor and control the projector over a network using Epson Web Control and PjLink.
Auto Configuration	On Off	(This setting may be unavailable depending on your projector model.) Set to <b>On</b> to assign addresses automatically according to the Router Advertisement.
Use Temporary Address	On Off	(This setting may be unavailable depending on your projector model.) Set to <b>On</b> if you want to use a temporary IPv6 address.
IP Address Display	On Off	Set to <b>On</b> to display the IP address on the network information screen and Home screen.

### » Related Links

- "List of Functions" [p.11](#)

## Network Menu - Mail Notification Menu

Settings on the **Mail Notification** menu let you receive an email notification if a problem or warning occurs in the projector.

Setting	Options	Description
Mail Notification	On Off	Set to <b>On</b> to send an email to the preset addresses when a problem or warning occurs with a projector.



Setting	Options	Description
SMTP Server	Up to 64 alphanumeric characters (do not use " * + , ; ; < = > ? [ \ ] `   spaces)	Enter the IP address or FQDN (Fully Qualified Domain Name) for the projector's SMTP server using 0 to 255 for each address field. Do not use these addresses: 127.x.x.x, 192.0.2.x or 224.0.0.0 through 255.255.255.255 (where x is a number from 0 to 255). DNS server settings are required when specifying an FQDN.
Authentication	Open Auth SSL TLS	Select the authentication type of the SMTP server.
Port Number	1 to 65535 (default is 25)	Enter a number for the SMTP server Port Number.
User Name	Up to 64 alphanumeric characters	Enter a user name for the SMTP server.
Password	Up to 64 alphanumeric characters	Enter a password for authentication on the SMTP server.
From	Up to 64 alphanumeric characters	Enter the email address of the sender. Enter an email address that does not contain personal information.
Address 1 Setting Address 2 Setting Address 3 Setting	(do not use " ( ) , ; ; < > [ \ ] spaces)	Enter the e-mail address, and select the alerts you want to receive. Enter an email address that does not contain personal information.

## Network Menu - Projector Control Menu

Settings on the **Projector Control** menu let you select settings for controlling the projector over a network.

Setting	Options	Description
Command Communication	Protected Compatible	Selects the authentication method for command communication. Set to <b>Protected</b> when performing a digest authentication using <b>Web Control Password</b> . You need to install the latest version of the Epson Projector Management software. Set to <b>Compatible</b> when performing plain text authentication using the <b>Monitor Password</b> . Select <b>Compatible</b> when monitoring projectors with a switcher and a system controller or using Epson Projector Management ver. 5.30 or earlier.
Monitor Password	Up to 16 alphanumeric characters (do not use spaces or any symbols other than @)	Enter a password for monitoring projectors with a switcher and a system controller, or using Epson Projector Management ver. 5.30 or earlier. Make sure that the <b>Monitor Password</b> matches the password set for the switcher or the system controller.
Web API Settings	Web API	Select <b>On</b> to enable the Web API function.

Setting	Options	Description
	Authentication	Select the authentication method for Web API communication. <b>Open:</b> Security is not set. <b>Digest:</b> Communication is performed using API authentication (Digest authentication). See the <i>Web API Specifications for Projectors</i> for details.
Basic Control	On Off	Set to <b>On</b> to monitor and control the projector using <b>Basic Control</b> in <b>Epson Web Control</b> .  This setting is only displayed when <b>Content Playback</b> is set to <b>Off</b> in the projector's <b>Operation</b> menu.
Remote Password	8 to 32 alphanumeric characters (do not use * : spaces)	Enter a password to access the projector using <b>Basic Control</b> in <b>Epson Web Control</b> . (The user name is EPSONREMOTE. No password is set by default.)
PJLink	On Off	Set to <b>On</b> to enable the PJLink notification function.
PJLink Password	Up to 32 alphanumeric characters (do not use spaces and any symbols)	Enter a password for using the PJLink protocol for projector control.

Setting	Options	Description
Notified IP Address	Various IP addresses	Enter the IP address to receive the projector's operating status when the PJLink notification function is enabled. Enter the addresses using 0 to 255 for each address field.  Do not use these addresses: 127.x.x.x or 224.0.0.0 through 255.255.255.255 (where x is a number from 0 to 255).
SNMP	SNMPv1/v2c	Set to <b>On</b> to monitor the projector using SNMPv1/v2c. To monitor the projector, you need to install the SNMP manager program on your computer. SNMP should be managed by a network administrator.
	Trap IP Address 1 Trap IP Address 2	Enter up to two IP addresses to receive SNMP notifications, using 0 to 255 for each address field.  Do not use these addresses: 224.0.0.0 through 255.255.255.255 (where x is a number from 0 to 255).
	Community Name	Enter the SNMP community name. You can use up to 32 alphanumeric characters (do not use spaces and any symbols).
	SNMPv3	Set to <b>On</b> to monitor the projector using SNMPv3. To monitor the projector, you need to install the SNMP manager program on your computer. SNMP should be managed by a network administrator.
	User name	Enter the SNMP user name. You can use up to 32 alphanumeric characters.

Setting	Options	Description
	Trap IP Address 1 Trap IP Address 2	Enter up to two IP addresses to receive SNMP notifications, using 0 to 255 for each address field.  Do not use these addresses: 224.0.0.0 through 255.255.255.255 (where x is a number from 0 to 255).
	Authentication	Selects the type of SNMPv3 authentication.
	Authentication Password	This password is used for the SNMPv3 authentication.  This must be set to use the feature securely.  You can use up to 32 alphanumeric characters.
	Encryption Type	Selects the type of SNMPv3 encryption.
	Encryption Password	This password is used for the SNMPv3 encryption.  This must be set to use the feature securely.  You can use up to 32 alphanumeric characters.
AMX Device Discovery	On Off	Set to <b>On</b> when you want to allow the projector to be detected by AMX Device Discovery.
Crestron Connected	On Off	Set to <b>On</b> only when monitoring or controlling the projector over the network using <b>Crestron Connected</b> .  Enabling <b>Crestron Connected</b> disables the Epson Message Broadcasting feature in the Epson Projector Management software.

Setting	Options	Description
Crestron XiO Cloud	On Off	Set to <b>On</b> to monitor or control your projector and other devices over the network using the Crestron XiO Cloud service.
Control4 SDDP	On Off	Set to <b>On</b> to allow device information to be acquired using Control4 Simple Device Discovery Protocol (SDDP).
Secure HTTP	On Off	To strengthen security, communication between the projector and computer in Web control is encrypted. When setting security with Web control, it is recommended to set this to <b>On</b> .
Web Server Certificate	—	Imports the Web server certificate for secure HTTP.

## Network Menu - Network Projection Settings

Settings on the **Network Projection** menu let you select the settings relates to network projection.

Setting	Options	Description
Projector Keyword	On Off	Set to <b>On</b> to enable a security password to prevent access to the projector by anyone not in the same room as the projector. You must enter a displayed, randomized keyword from a computer using Epson iProjection to access the projector and share the current screen.
Epson iProjection	On Off	Set to <b>On</b> to use Epson iProjection.

Setting	Options	Description
SSID Display	On Off	Set to <b>On</b> to display the SSID on the network information screen and Home screen.
LAN Info. Settings	Text & QR Code Text	Sets the display format for the projector's network information.  By simply reading the QR code with Epson iProjection, you can connect the mobile device to the projector through a network.
Moderator Password	Four-digit number	Enter a password for accessing the projector as a moderator using Epson iProjection. (No password is set by default.)
Keyword Interrupt Display	On Off	Set to <b>On</b> to display a projector keyword on the projected image when accessing the projector using Epson iProjection.  Available when <b>Projector Keyword</b> is set to <b>On</b> .
Miracast	On Off	(This setting may be unavailable depending on your projector model.) Set to <b>On</b> to use the Miracast feature.
Access Control	On Off	(This setting may be unavailable depending on your projector model.) Set to <b>On</b> to display a confirmation screen that asks whether to allow projection each time a Miracast connection is made.

Setting	Options	Description
Secondary Connections	Interruptions OK No Interruptions Off	(This setting may be unavailable depending on your projector model.) Selects the connection behavior for devices attempting to connect during a Miracast connection.  <ul style="list-style-type: none"> <li>• <b>Interruptions OK:</b> Images from devices that connect subsequently are projected as the Miracast1 source. If the subsequent device is disconnected when <b>Access Control</b> is set to <b>On</b>, images from the previously connected device are projected as the Miracast1 source. You can connect up to two devices to the projector at the same time.  When <b>Access Control</b> is set to <b>Off</b>, the previously connected device is disconnected.</li> <li>• <b>No Interruptions:</b> A second device can connect to the projector while images from the previously connected device continue to be projected as the Miracast1 source. If you switch the source to Miracast2, images from the second device are projected. You can connect up to two devices to the projector at the same time.</li> <li>• <b>Off:</b> No additional devices can connect to the projector during Miracast connection.</li> </ul>
Adjust Image Quality	1 (Fine) 2 3 4 (Fast)	(This setting may be unavailable depending on your projector model.) Adjusts the Miracast speed/quality. 1: increases image quality. 4: increases processing speed.

Setting	Options	Description
Miracast Info.	On Off	(This setting may be unavailable depending on your projector model.) Set to <b>On</b> to display connection information when projecting from a Miracast source.
Message Broadcasting	On Off	Set to <b>On</b> to receive the message delivered by Epson Projector Management. See the <i>Epson Projector Management Operation Guide</i> for details. Setting is only displayed when <b>Crestron Connected</b> is set to <b>Off</b> in the projector's <b>Projector Control</b> menu.
Screen Sharing	On Off	Set to <b>On</b> to enable screen sharing between network projectors.
Connection Mode	Keyword On Keyword Off	Set to <b>Keyword Off</b> to skip authentication of keywords for other projectors so you can quickly connect to them.

You can display information about the projector and version by viewing the **Info** menu. However, you cannot change any settings in the menu.

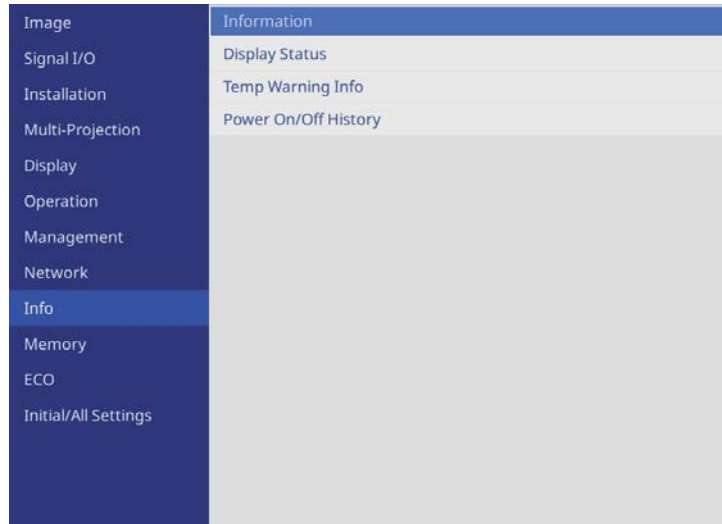

Information item	Description
Information	Displays information about the projector and input sources. The displayed items vary depending on the current input source.
Display Status	Displays the projector's status information.
Temp Warning Info	Displays various high temperature warnings.
Power On/Off History	Displays the projector's power on and power off history.

Settings on the **Memory** menu let you manage saving and loading of image quality settings in the projector's memory.

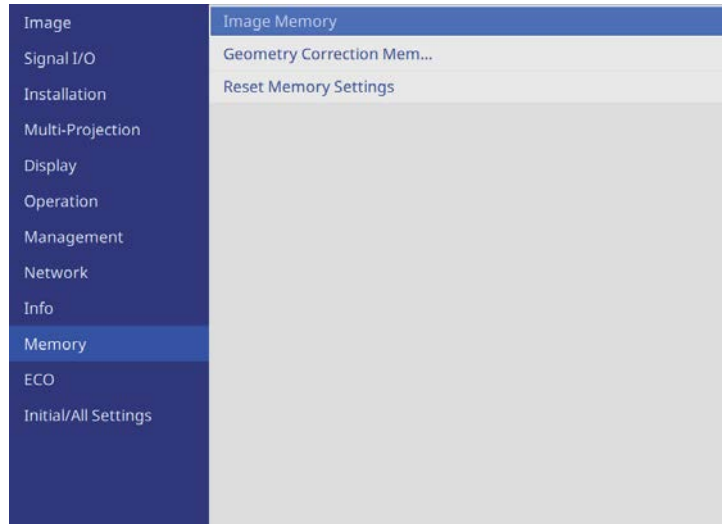

Setting	Options	Description
Image Memory	—	Saves image adjustment settings and changes the memory name.
Geometry Correction Memory	—	Saves the geometry correction settings and changes the memory name.
Reset Memory Settings	—	Resets all saved memories.

## ► Related Links

- "Saving Settings to Memory and Using Saved Settings " [p.116](#)

Settings on the ECO menu let you customize projector functions to save power.

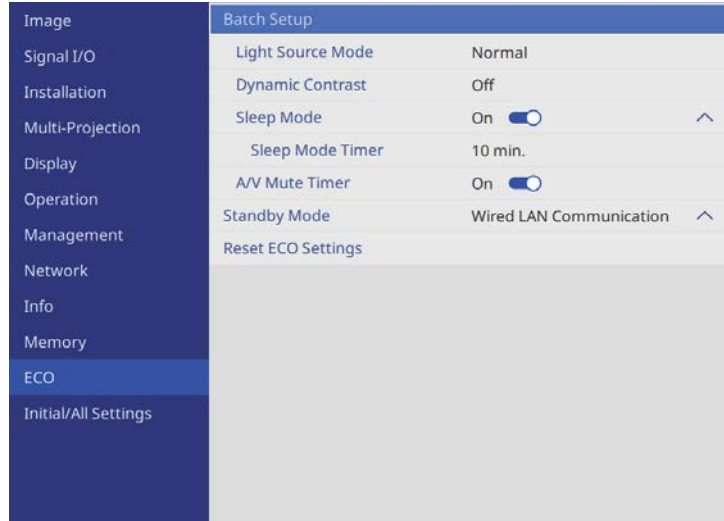

Setting	Options	Description
Sleep Mode Timer	—	See the <b>Operation</b> menu table for details on the <b>Sleep Mode Timer</b> settings.
A/V Mute Timer	—	See the <b>Operation</b> menu table for details on the <b>A/V Mute Timer</b> settings.
Standby Mode	—	See the <b>Operation</b> menu table for details on the <b>Standby Mode</b> settings.
Reset ECO Settings	—	Resets all adjustment values on the <b>ECO</b> menu to their default settings.

► **Related Links**

- "Image Quality Settings - Image Menu" [p.193](#)
- "Projector Feature Settings - Operation Menu" [p.204](#)

Setting	Options	Description
Batch Setup	—	Performs the following settings at once to save power. <ul style="list-style-type: none"> <li>• Light Source Mode</li> <li>• Dynamic Contrast</li> <li>• Sleep Mode</li> <li>• Sleep Mode Timer</li> <li>• A/V Mute Timer</li> </ul>
Light Source Mode	—	See the <b>Operation</b> menu table for details on the <b>Light Source Mode</b> settings.
Dynamic Contrast	—	See the <b>Image</b> menu table for details on the <b>Dynamic Contrast</b> settings.
Sleep Mode	—	See the <b>Operation</b> menu table for details on the <b>Sleep Mode</b> settings.



Settings on the **Initial/All Settings** menu let you reset certain projector settings to their default values and place the projector in firmware update mode so you can update the firmware.

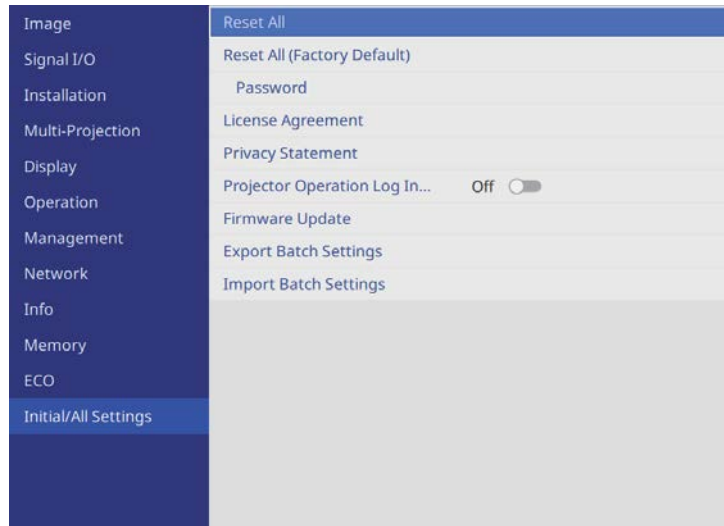

Setting	Options	Description
Projector Operation Log Information	—	(This setting may be unavailable depending on your projector model.) Selects whether to send projector operation log information to Epson.
Firmware Update	Update by USB Update over Network	(These settings may be unavailable depending on your projector model.) Updates the projector firmware using the USB-A port or Service port. <ul style="list-style-type: none"> <li>• <b>Update by USB:</b> updates by USB with the pre-downloaded firmware file.</li> <li>• <b>Update over Network:</b> updates over a network.</li> </ul>
Export Batch Settings	Yes No	Exports the projector's menu settings to a USB flash drive or a computer, allowing you to copy them to other projectors of the same model.
Import Batch Settings	Yes No	Imports menu settings that have been saved to a USB flash drive or a computer.

Setting	Options	Description
Reset All	—	Lets you select menus for resetting the settings to default values.
Reset All (Factory Default)	—	Resets all of the projector settings to their default values. Set your password if needed.
License Agreement	—	(This setting may be unavailable depending on your projector model.) Displays the license agreement.
Privacy Statement	—	(This setting may be unavailable depending on your projector model.) Displays the privacy statement.

### Reset All options

When you select **Reset All**, you see the following screen.

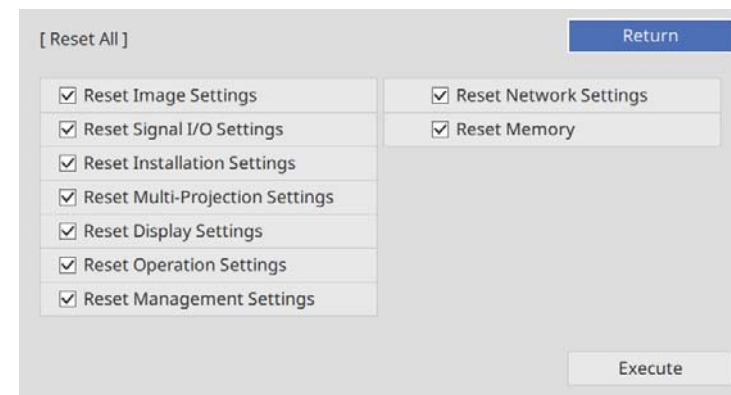

If you do not want to reset values in particular menus, deselect the check box next to the menu name. When you are ready to reset setting values, select **Execute**.

You cannot reset the following settings:

- **Language**

## Attention

If you perform **Reset All**, all of the passwords that have been set for the **Network** menu are also reset and you need to set them again. To prevent the passwords from being reset by unauthorized users, set **Network** to **On** in the **Menu Protection** menu.



For the **Network** menu, if you turn on the **Menu Protection** setting, the settings do not return to their default values when using the **Reset All** option.

## Reset All (Factory Default) option

You cannot reset the following settings using the **Reset All (Factory Default)** option:

- Date & Time
- Light Source Hours
- Password
- Password Protection settings
- Schedule Settings \*

\* This setting is reset when you set **Schedule Protection** to **Off**.

## Attention

If you perform **Reset All (Factory Default)**, all of the passwords that have been set for the **Network** menu are also reset and you need to set them again. To prevent the passwords from being reset by unauthorized users, set **Network** to **On** in the **Menu Protection** menu.

## ►► Related Links

- "Updating the Firmware" [p.238](#)

After selecting the projector's menu settings for one projector, you can use the following methods to copy the settings to other projectors, as long as they are the same model.

- by using a USB flash drive
- by connecting a computer and projector using a USB cable
- by using Epson Projector Management

You cannot copy any information unique to an individual projector, such as **Light Source Hours** or **Status**.



- Perform batch setup before adjusting the image settings such as keystone distortion correction. Since image adjustment values are also copied to another projector, the adjustments you made before performing the batch setup are overwritten and the projected screen you adjusted may change.
  - When copying the menu settings from one projector to another, user's logo is also copied. Do not register the information that you do not want to share between multiple projectors as a user's logo.
  - Make sure **Batch Setup Range** is set to **Limited** if you do not want to copy the following settings:
    - **Password Protection** settings
    - EDID in the **Signal I/O** menu
    - **Network** menu settings
- ☞ **Operation > Operation Settings > Batch Setup Range**

## **Caution**

Epson takes no responsibility for batch setup failures and associated repair costs due to power outages, communication errors, or other problems that may cause such failures.

## ▶ **Related Links**

- "Transferring Settings From a USB Flash Drive" [p.227](#)
- "Transferring Settings From a Computer" [p.228](#)

## Transferring Settings From a USB Flash Drive

You can copy menu settings from one projector to another of the same model using a USB flash drive.



- The USB flash drive must use a FAT16/32 format and not incorporate any security function. Delete any files on the drive before using it for batch setup or the settings may not be saved correctly.
- You can also use this batch setup method from the projector's menu.

- 1** Disconnect the power cord from the projector, and check that all of the projector's indicators have turned off.
- 2** Connect an empty USB flash drive directly to the projector's USB-A port.
- 3** Hold down the [Esc] button on the remote control or the control panel and connect the power cord to the projector.
- 4** When all of the projector's indicators turn on, release the [Esc] button. The indicators start flashing and the batch setup file is written to the USB flash drive. When writing is finished, the projector turns off.

## **Caution**

Do not disconnect the power cord or the USB flash drive from the projector while the file is being written. If the power cord or USB flash drive is disconnected, the projector may not start correctly.

- 5** Remove the USB flash drive.



The file name for the batch setup file is PJCONFDATA.bin. If you need to change the file name, add text after PJCONFDATA using only alphanumeric characters. If you change the PJCONFDATA section of the file name, the projector may not be able to recognize the file correctly.

- 6** Disconnect the power cord from the projector to which you want to copy settings, and check that all of the projector's indicators have turned off.
- 7** Connect the USB flash drive containing the saved batch setup file to the projector's USB-A port.
- 8** Hold down the [Menu] button on the remote control or the control panel and connect the power cord to the projector.
- 9** When all of the projector's indicators turn on, release the [Menu] button. When all of the indicators start flashing, the settings are being written. When writing is finished, the projector turns off.

**⚠ Caution**

Do not disconnect the power cord or the USB flash drive from the projector while the file is being written. If the power cord or USB flash drive is disconnected, the projector may not start correctly.

- 10** Remove the USB flash drive.

## Transferring Settings From a Computer

You can copy menu settings from one projector to another of the same model by connecting the computer and projector with a USB cable.



- You can use this batch setup method with the following operating system versions:
  - Windows 10 and later
  - macOS 10.12.x and later
- You can also use this batch setup method from the projector's menu.

- 1** Disconnect the power cord from the projector, and check that all of the projector's indicators have turned off.
- 2** Connect a USB cable to the computer's USB port and to the projector's Service port.
- 3** Hold down the [Esc] button on the remote control or the control panel and connect the power cord to the projector.
- 4** When all of the projector's indicators turn on, release the [Esc] button. The computer recognizes the projector as a removable disk.
- 5** Open the removable disk icon or folder, and save the batch setup file to the computer.



The file name for the batch setup file is PJCONFDATA.bin. If you need to change the file name, add text after PJCONFDATA using only alphanumeric characters. If you change the PJCONFDATA section of the file name, the projector may not be able to recognize the file correctly.

- 6** Eject the USB device (Windows) or drag the removable disk icon to the Trash (Mac).
- 7** Disconnect the USB cable. The projector turns off.

- 8** Disconnect the power cord from the projector to which you want to copy settings, and check that all of the projector's indicators have turned off.
- 9** Connect the USB cable to the computer's USB port and to the projector's Service port.
- 10** Hold down the [Menu] button on the remote control or the control panel and connect the power cord to the projector.
- 11** When all of the projector's indicators turn on, release the [Menu] button. The computer recognizes the projector as a removable disk.
- 12** Copy the batch setup file (PJCONFDATA.bin) that you saved to your computer to the top level folder of the removable disk.



Do not copy any files or folders other than the batch setup file to the removable disk.

- 13** Eject the USB device (Windows) or drag the removable disk icon to the Trash (Mac).
- 14** Disconnect the USB cable.  
When all of the indicators start flashing, the settings are being written. When writing is finished, the projector turns off.

**⚠ Caution**

Do not disconnect the power cord from the projector while the file is being written. If the power cord is disconnected, the projector may not start correctly.

## Batch Setup Error Notification

The projector's indicators notify you if an error occurs during a batch setup operation. Check the status of the projector's indicators and follow the instructions described in the table here.

Indicator status	Problem and solutions
<ul style="list-style-type: none"> <li>• Laser: Orange - flashing fast</li> <li>• Temp: Orange - flashing fast</li> </ul>	<p>The batch setup file may be corrupt, or the USB flash drive may not be connected correctly.</p> <p>Disconnect the USB flash drive, unplug and then plug in the projector's power cord, and then try again.</p>
<ul style="list-style-type: none"> <li>• Power: Blue - flashing fast</li> <li>• Status: Blue - flashing fast</li> <li>• Laser: Orange - flashing fast</li> <li>• Temp: Orange - flashing fast</li> </ul>	<p>Writing the settings may have failed and an error may have occurred in the projector's firmware.</p> <p>Stop using the projector, remove the power plug from the electrical outlet. Contact Epson for help.</p>

▶ **Related Links**

- "Batch Setup Error Notification" [p.229](#)

# Maintaining the Projector

Follow the instructions in these sections to maintain your projector.

## ► Related Links

- "Projector Maintenance" [p.231](#)
- "Cleaning the Lens" [p.232](#)
- "Cleaning the Projector Case" [p.233](#)
- "Air Filter and Vent Maintenance" [p.234](#)
- "Updating the Firmware" [p.238](#)

You may need to clean the projector's lens periodically, and clean the air filter and air vents to prevent the projector from overheating due to blocked ventilation.

The only parts you should replace are the air filter and remote control batteries. If any other part needs replacing, contact Epson or an authorized Epson servicer.

 **Warning**

Before cleaning any part of the projector, turn it off and unplug the power cord. Never open any cover on the projector, except as specifically explained in this manual. Dangerous electrical voltages in the projector can injure you severely.

Clean the projector's lens periodically, or whenever you notice dust or smudges on the surface.

- To remove dust or smudges, gently wipe the lens with clean and dry lens-cleaning paper.
- If the lens is dusty, blow off dust using a blower, and then wipe the lens.

## **Warning**

- Before cleaning the lens, turn off the projector and unplug the power cord.
- Do not use any flammable gas sprays such as air dusters to blow off dust. The high heat generated by the projector may cause a fire.

## **Attention**

- Do not wipe the lens right after you turn off the projector. Doing so could damage the lens.
- Do not use any harsh materials to clean the lens and do not subject the lens to any impacts; otherwise, it could be damaged.



Before cleaning the projector case, turn off the projector and unplug the power cord.

- To remove dust or dirt, use a soft, dry, lint-free cloth.
- To remove stubborn dirt, use a soft cloth moistened with water and mild soap. Do not spray liquid directly on the projector.

**Attention**

Do not use wax, alcohol, benzene, paint thinner, or other chemicals to clean the projector case. These can damage the case. Do not use canned air, or the gases may leave a flammable residue.

Regular filter maintenance is important to maintain your projector. Clean the air filter when a message appears telling you the temperature inside the projector has reached a high level. It is recommended that you clean these parts over a 20,000-hour period. Clean them more often than this if you use the projector in an environment that is dustier than expected. (Assuming the projector is used in an atmosphere in which airborne particulate matter is less than 0.04 to 0.2 mg/m<sup>3</sup>.)

## Attention

If regular maintenance is not performed, your Epson projector will notify you when the temperature inside the projector has reached a high level. Do not wait until this warning appears to maintain your projector filter as prolonged exposure to high temperatures may reduce the life of your projector.

## ► Related Links

- "Cleaning the Air Filters and Intake Vents" [p.234](#)
- "Replacing the Air Filter" [p.236](#)

## Cleaning the Air Filters and Intake Vents

You need to clean the projector's air filters in the following situations:

- The filter or vents get dusty.
- You see a message telling you to clean it.
- The projector's Filter indicator flashes orange.

**1** Turn off the projector and unplug the power cord.

**2** Carefully remove the dust using a vacuum cleaner or a brush.

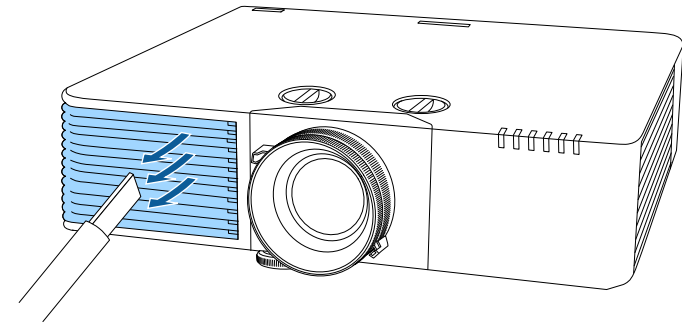

**3** Turn the projector upside down.

## Attention

When placing the projector upside down, be sure to place a cloth or other cushioning material underneath the projector to protect the lens. (EB-L790SE/EB-L795SE/EB-L690SE/EB-L695SE/EB-L790SU/EB-L690SU/EB-L695SU)

**4** Loosen the screws and open the air filter cover.

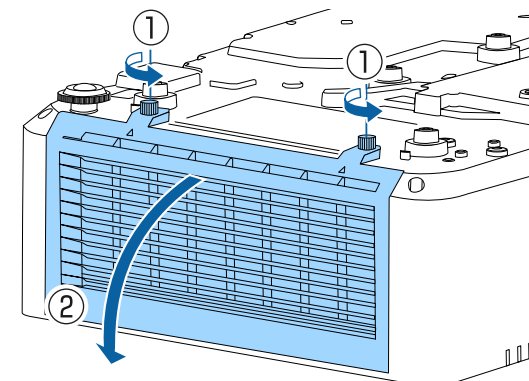

**5** Pull the air filter out of the projector.

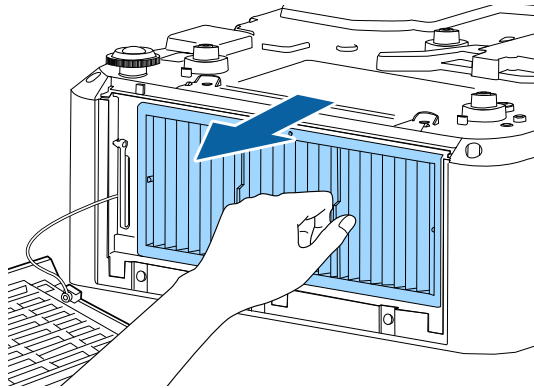

**6** Tap each side of the air filter 4 to 5 times to shake off any excess dust.

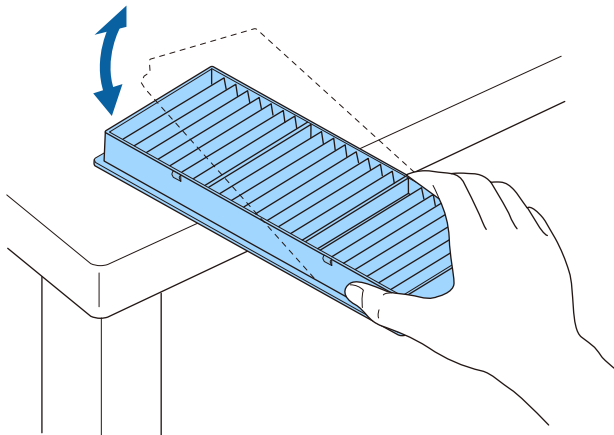

**Attention**

Do not use excessive force when tapping the air filter, or it may crack and become unusable.

**7** Vacuum the front of the air filter (the side with the tabs) to remove any remaining dust.

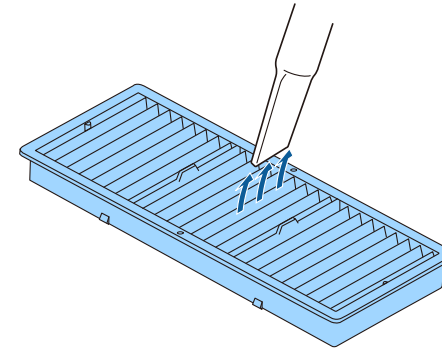

**Attention**

- Do not rinse the air filter in water, or use any detergent or solvent to clean it.
- Do not use canned air. The gases may leave a flammable residue or push dust and debris into the projector's optics or other sensitive areas.

**8** Place the air filter in the projector as shown.

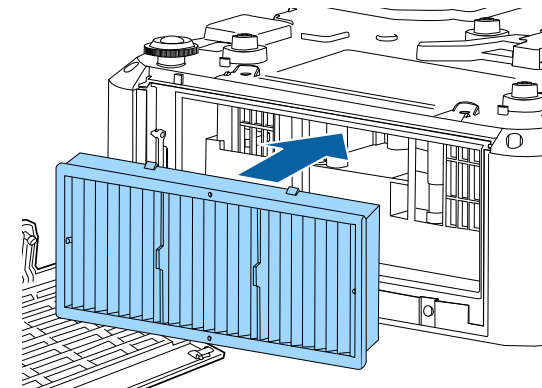

**9** Close the air filter cover and tighten the screws.

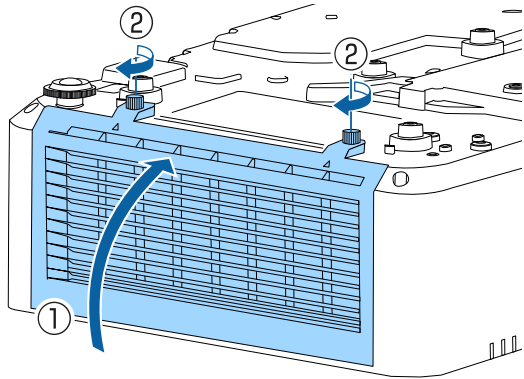

**3** Loosen the screws and open the air filter cover.

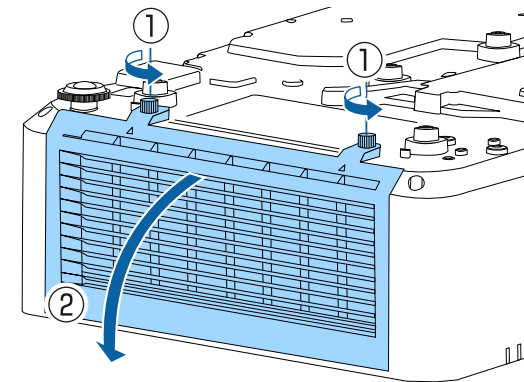

## Replacing the Air Filter

You need to replace the air filter in the following situations:

- After cleaning the air filter, you see a message telling you to clean or replace it.
- After cleaning the air filter, the projector's Filter indicator flashes orange.
- The air filter is torn or damaged.

You can replace the air filter while the projector is mounted to the ceiling or placed on a table.

**1** Turn off the projector and unplug the power cord.

**2** Turn the projector upside down.

**4** Pull the air filter out of the projector.

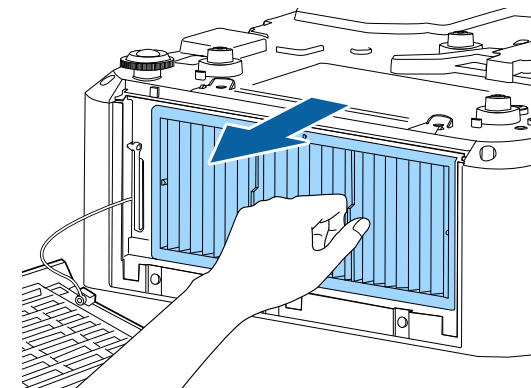

Dispose of used air filters according to local regulations.

- Filter frame: Polypropylene
- Filter: Polypropylene, PET

- 5** Place the new air filter in the projector as shown.

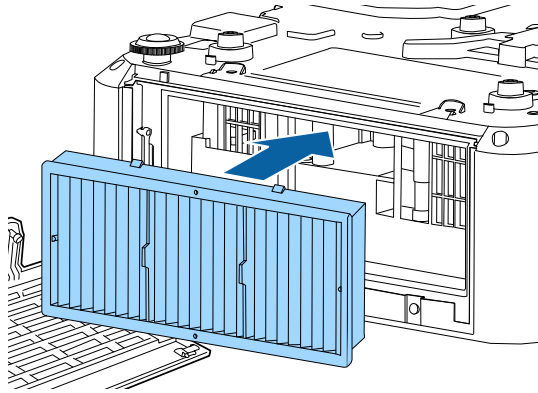

- 6** Close the air filter cover and tighten the screws.

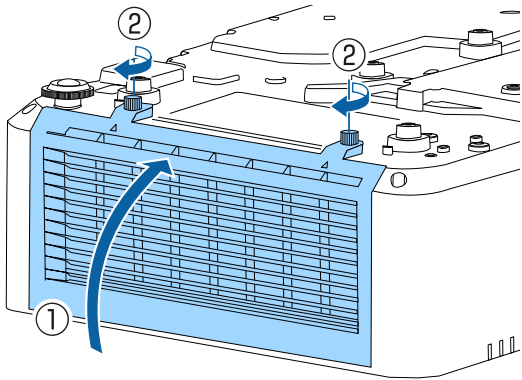

► **Related Links**

- "Replacement Parts" [p.265](#)

When you select the **Firmware Update** option in the projector's **Initial/All Settings** menu, the projector enters firmware update mode and is ready to perform a firmware update using the USB-A or Service port.

You can also update the projector's firmware over the network using the Epson Projector Management Connected or Epson Projector Management software. See the *Epson Projector Management Connected Operation Guide* or *Epson Projector Management Operation Guide* for instructions.



- When a firmware update is being performed over a network, you cannot perform a firmware update from the projector menu. (EB-L890E/EB-L895E/EB-L790SE/EB-L795SE/EB-L690E/EB-L890U/EB-L895U/EB-L790U/EB-L790SU/EB-L690U/EB-L690SU/EB-L695SU)
- The method for updating the firmware differs depending on your projector model. For details, see the "List of Functions" in this manual.

## ► Related Links

- "Updating Firmware Using a USB Storage Device" [p.238](#)
- "Updating the Firmware over the Network" [p.240](#)
- "List of Functions" [p.11](#)

## Updating Firmware Using a USB Storage Device

You can update the projector's firmware using a USB storage device.



Responsibility for updating the firmware lies with the customer. If a firmware update fails due to problems such as a power failure or communication problems, a fee will be charged for any necessary repairs.

- 1** Download the projector firmware file from the Epson Web site.

- 2** Copy the downloaded firmware file to the root folder (highest folder in the hierarchy) of the USB storage device.



- The USB storage device must be formatted in FAT format.
- Do not copy any other files to the USB storage device.
- Do not change the firmware's file name. If the file name is changed, the firmware update will not start.
- Check that the firmware file you copied is the correct file for your projector model. If the firmware file is not correct, the firmware update will not start.

- 3** Connect the USB storage device to the projector's USB-A port.



Connect the USB storage device directly to the projector. If the USB storage device is connected using a USB hub, the firmware update may not be applied correctly.

- 4** Press the [Menu] button, select the **Initial/All Settings** menu, and press [Enter].

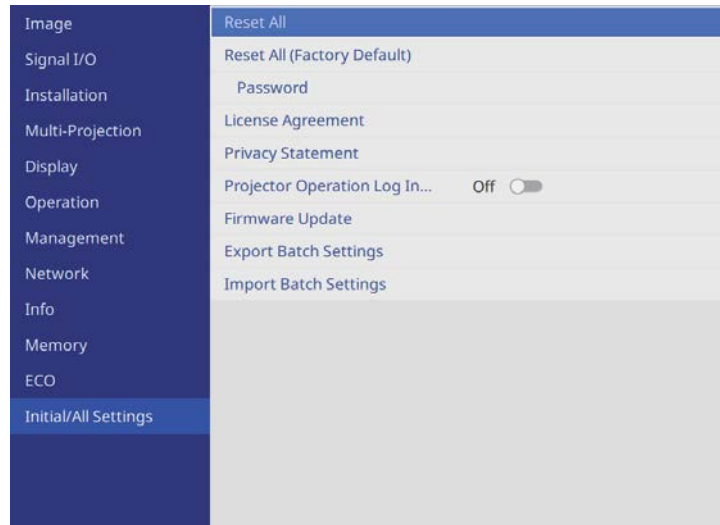

- 5** Select **Firmware Update** and press [Enter].



Do not select **Firmware Update** during the network firmware update. Wait until the network firmware update is complete before updating the projector.

- 6** Select **Update by USB** and press [Enter].



Set **Log Save Destination** to **Ineternal Memory** in the projector's **Operation** menu beforehand.

☛ **Operation > Operation Settings > Log Save Destination**

- 7** Select **Yes** to start the firmware update.  
The Firmware Update screen is displayed.

- 8** Select List update and press [Enter].

- 9** Select the file listed and press [Enter].

- 10** Select Transfer and press [Enter] to start the firmware update.



- Do not disconnect the power cord from the projector while the firmware is updating. If the power cord is disconnected, the projector may not start correctly.
- Do not disconnect the USB storage device from the projector while the firmware is updating. If the USB storage device is disconnected, the update may not be applied correctly.

All of the projector's indicators start flashing and the firmware update starts.

- 11** Once the update is complete, Reboot is displayed. Select Reboot and press [Enter].

When the update finishes, check the projector's **Info** menu to make sure that the **Version** information has been updated to the correct firmware version.

☛ **Info > Information > Version**



- When all indicators flash rapidly, the firmware update may have failed. Disconnect the power cord from the projector, and then reconnect it to the projector. If the indicators continue to flash even after reconnecting the power cord, remove the power plug from the electrical outlet and contact Epson.
- If the firmware update fails due to a timeout or other issues, check the following.
  - Make sure there is enough free space on the USB storage device.
  - Make sure the USB storage device is not write-protected.

## ► Related Links

- "List of Functions" p.11

## Updating the Firmware over the Network

Once the latest firmware has been uploaded to the server, you can update the projector's firmware over the network.

The procedures for updating the firmware vary depending on the settings in **Firmware Update Set.** from the **Network** menu.

- **Notify:** When the projector is turned on, a firmware update confirmation screen is displayed.  
Select OK to start the update.
- **Do not notify:** You can update the firmware from the **Initial/All Settings** menu.
- **Auto update at midnight:** When the projector is in standby mode, the firmware is automatically updated between 12:00 AM and 4:00 AM.
- **Off:** Disables firmware updates over the network.



- You need to configure a DNS server to update the firmware over the network.  
Depending on your network, set **DHCP** to **On** in **IP Settings** from the **Wired LAN** menu or the **Wireless LAN** menu. If **DHCP** is set to **Off** or if you want to specify a DNS server address, enter the IP address in **DNS Server 1** or **DNS Server 2**.
  - ☛ **Network > Network Settings > Wireless LAN**
  - ☛ **Network > Network Settings > Wired LAN**
- If you are using Epson Projector Management Connected, we recommend setting **Firmware Update Set.** to **Off** in the **Network** menu.

If **Firmware Update Set.** is set to **Do not notify** in the **Network** menu, follow the steps below to update the firmware.

If **Firmware Update Set.** is set to **Notify** and you did not select **OK** when turning on the projector, or if it is set to **Auto update at midnight** but the update was not performed because the projector was on, you can update the firmware using the same procedure.

- 1** Press [Menu], select **Initial/All Settings**, and then press [Enter].
- 2** Select **Firmware Update** and press [Enter].
- 3** Select **Update over Network** and press [Enter].



- If the latest firmware has not been uploaded to the server, you cannot select **Update over Network**.
- If **Firmware Update Set.** is set to **Off** in the **Network** menu, you cannot select **Update over Network**.

- 4** Select **Yes** to start the firmware update.



Do not disconnect the power cord from the projector while the firmware is updating. If the power cord is disconnected, the projector may not start correctly.

All of the projector's indicators start flashing and the firmware update starts. When the update finishes normally, the projector enters standby status (only the power indicator is lit blue). If **Direct Power On** is set to **On** in the projector's **Operation** menu, the projector turns back on again.

☛ **Operation > Operation Settings > Direct Power On**

When the update finishes, check the projector's **Info** menu to make sure that the **Version** information has been updated to the correct firmware version.

☛ **Info > Information > Version**





When all indicators flash rapidly, the firmware update may have failed.

Disconnect the power cord from the projector, and then reconnect it to the projector. If the indicators continue to flash even after reconnecting the power cord, remove the power plug from the electrical outlet and contact Epson.

## ▶ Related Links

- "Projector Network Settings - Network Menu" [p.211](#)
- "Projector Information Display - Info Menu" [p.222](#)
- "Projector Feature Settings - Operation Menu" [p.204](#)
- "Projector Initial Settings and Reset Options - Initial/All Settings Menu" [p.225](#)

# Solving Problems

Check the solutions in these sections if you have any problems using the projector.

## ► Related Links

- "Projection Problems" [p.243](#)
- "Projector Indicator Status" [p.244](#)
- "Viewing the Status Display" [p.247](#)
- "Solving Image or Sound Problems" [p.248](#)
- "Solving Projector or Remote Control Operation Problems" [p.255](#)
- "Solving Network Problems" [p.257](#)
- "Solutions to Problems in Content Playback Mode" [p.261](#)
- "Solutions When HDMI Link does not Function" [p.262](#)

If the projector is not working properly, turn it off, unplug it, and then plug it back in and turn it on.

If this does not solve the problem, check the following:

- The indicators on the projector may indicate the problem.
- The solutions in this manual can help you solve many problems.

If none of these solutions help, contact Epson for technical support.



After repairing the projector, Epson may return the projector to you in its initial status. Make sure you make a note of the account information of each online service before you contact your local dealer or the nearest Epson repair center.

🖱️ **Operation > Operation Settings > Indicators**

The indicators on the projector indicate the projector status and let you know when a problem occurs. Check the status and color of the indicators and then refer to this table for a solution.



- If the indicators display a pattern not listed in the table below, turn the projector off, unplug it, and contact Epson for help.
- When the **Indicators** setting is set to **Off** in the projector's **Operation** menu, all indicators are off.
  - **Operation > Operation Settings > Indicators**

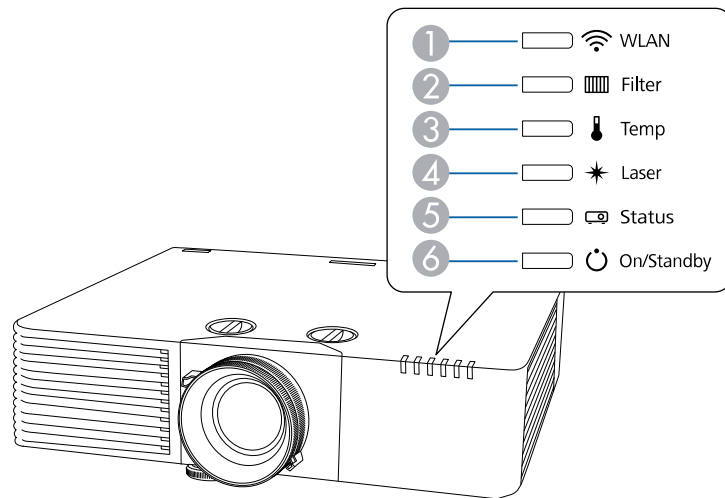

- ① WLAN (wireless LAN) indicator
- ② Filter indicator
- ③ Temp (temperature) indicator
- ④ Laser indicator
- ⑤ Status indicator
- ⑥ On/Standby (power) indicator

## Projector status

Indicator and status	Problem and solutions
Power: Lit blue Status: Lit blue Laser: Off Temp: Off Filter: Off	Normal operation.
Power: Lit blue Status: Flashing blue Laser: Off Temp: Off Filter: Off	Warming up, shutting down, or cooling down. When warming up, wait about 30 seconds for an image to appear. All buttons are disabled during warm-up, shutting down, and cooling down.
Power: Lit blue Status: Off Laser: Off Temp: Off Filter: Off	Standby, sleep mode, or monitoring. When you press the power button, projection starts.
Power: Flashing blue Status: Off Laser: Off Temp: Off Filter: Off	Preparing for monitoring or quick startup mode. All features are disabled.
Power: Indicator status varies Status: Flashing blue Laser: Flashing orange Temp: Indicator status varies Filter: Indicator status varies	Refresh Mode is in progress. ➤ <b>Management &gt; Refresh Mode</b>

Indicator and status	Problem and solutions
Power: Lit blue Status: Lit blue Laser: Lit orange Temp: Lit orange Filter: Off	Batch Setup is in progress. Saving to memory ready/Writing to device ready.
Power: Flashing blue Status: Flashing blue Laser: Flashing orange Temp: Flashing orange Filter: Off	Batch Setup is in progress. Saving to memory/Writing to device.
Power: Flashing blue Status: Indicator status varies Laser: Indicator status varies Temp: Flashing orange Filter: Indicator status varies	Projector is too hot. <ul style="list-style-type: none"> <li>• Make sure that the vents and air filter are not clogged with dust or obstructed by nearby objects.</li> <li>• Clean or replace the air filter.</li> <li>• Make sure the environmental temperature is not too hot.</li> </ul>
Power: Off Status: Flashing blue Laser: Off Temp: Lit orange Filter: Off	Projector has overheated and turned off. Leave it turned off to cool down for 5 minutes. <ul style="list-style-type: none"> <li>• Make sure that the vents and air filter are not clogged with dust or obstructed by nearby objects.</li> <li>• Make sure the environmental temperature is not too hot.</li> <li>• Clean or replace the air filter.</li> <li>• If operating the projector at high altitude, set the <b>High Altitude Mode</b> setting to <b>On</b> in the projector's <b>Installation</b> menu.</li> <li>• If the problem persists, unplug the projector and contact Epson for help.</li> </ul>

Indicator and status	Problem and solutions
Power: Flashing blue Status: Indicator status varies Laser: Flashing orange Temp: Indicator status varies Filter: Indicator status varies	Laser warning. Turn the projector off, unplug it, and contact Epson for help.
Power: Off Status: Flashing blue Laser: Lit orange Temp: Off Filter: Off	Laser has a problem. Turn the projector off, unplug it, and contact Epson for help.
Power: Off Status: Flashing blue Laser: Off Temp: Flashing orange Filter: Off	A fan or sensor has a problem. Turn the projector off, unplug it, and contact Epson for help.
Power: Off Status: Flashing blue Laser: Flashing orange Temp: Off Filter: Off	Internal projector error. Turn the projector off, unplug it, and contact Epson for help.

Indicator and status	Problem and solutions
Power: Indicator status varies Status: Indicator status varies Laser: Indicator status varies Temp: Indicator status varies Filter: Flashing orange	It is time to clean the air filter.
Power: Flashing blue Status: Indicator status varies Laser: Indicator status varies Temp: Indicator status varies Filter: Lit orange	Low air flow through the air filter. <ul style="list-style-type: none"> <li>• Make sure that the vents and air filter are not clogged with dust or obstructed by nearby objects.</li> <li>• Clean or replace the air filter.</li> <li>• If the problem persists, unplug the projector and contact Epson for help.</li> </ul>
Power: Off Status: Flashing blue Laser: Off Temp: Off Filter: Lit orange	Low air flow through the projector. <ul style="list-style-type: none"> <li>• Make sure that the vents and air filter are not clogged with dust or obstructed by nearby objects.</li> <li>• Clean or replace the air filter.</li> <li>• If the problem persists, unplug the projector and contact Epson for help.</li> </ul>
Power: Indicator status varies Status: Indicator status varies Laser: Flashing orange Temp: Indicator status varies Filter: Indicator status varies	The projector is unable to maintain constant brightness and the setting is disabled.  <b>Operation &gt; Light Source Brightness Control &gt; Maintain Brightness</b>

Indicator and status	Problem and solutions
Power: Off Status: Flashing blue Laser: Lit orange Temp: Lit orange Filter: Off	Supply Voltage error Communication error with AC Micro controller Turn the projector off, unplug it, and contact Epson for help.

### Wireless LAN status

Wireless LAN indicator status	Problem and solutions
Lit blue	Wireless LAN is available or the projector is operating in simple AP mode.
Flashing blue (quickly)	Connecting to the access point.
Flashing blue (slowly)	An error has occurred. Turn off the projector and then on again.
Off	Wireless LAN is not available. Make sure the wireless LAN settings are correct.

### » Related Links

- "Cleaning the Air Filters and Intake Vents " [p.234](#)
- "Replacing the Air Filter" [p.236](#)

You can monitor the projector's status and view error information from the status display.

- 1** Turn on the projector.
- 2** Press the [Menu] button on the control panel or remote control.
- 3** Select the **Info** setting and press [Enter].

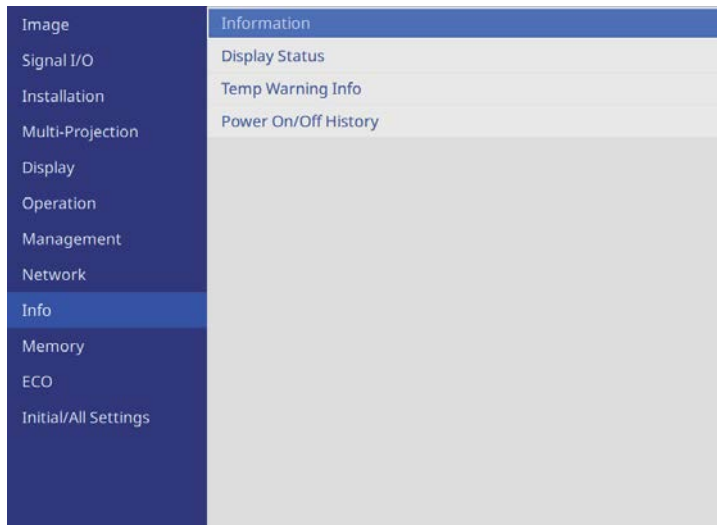

- 4** Select **Display Status** and press [Enter].
- 5** Press the left or right arrow buttons to view different categories of the following information.
  - **System:** The projector's system status
  - **Version:** The projector's firmware version
  - **Network Wired:** Wired LAN settings
  - **Network Wireless:** Wireless LAN settings

- **Input Signal:** Input signal information
- **Output Signal:** Output signal information



Status messages are available only in English. See the *Supplemental Guide for Display Status Menu* for details.

Check the solutions in these sections if you have any problems with projected images or sound.

## ▶▶ Related Links

- "Solutions When No Image Appears" [p.248](#)
- "Solutions When "No Signal" Message Appears" [p.248](#)
- "Solutions When "Not Supported" Message Appears" [p.249](#)
- "Solutions When Only a Partial Image Appears" [p.250](#)
- "Solutions When the Image Contains Noise or Static" [p.250](#)
- "Solutions When the Image is Fuzzy or Blurry" [p.251](#)
- "Solutions When the Image is not Rectangular" [p.251](#)
- "Solutions When the Image Brightness or Colors are Incorrect" [p.251](#)
- "Solutions When Automatic Adjustments are not Applied Correctly" [p.252](#)
- "Solutions When Simple Stacking is not Applied Correctly" [p.253](#)
- "Solutions When Simple Blending is not Applied Correctly" [p.253](#)
- "Solutions When an Afterimage Remains on the Projected Image" [p.253](#)
- "Solutions to Sound Problems" [p.253](#)
- "Solutions When Image File Names are not Displayed Correctly in PC Free" [p.254](#)
- "Solutions When You Cannot Project Images Using the PC Free Feature" [p.254](#)

---

## Solutions When No Image Appears

If no image appears, try the following solutions:

- Press the [A/V Mute] button on the projector or remote control to see if the image was temporarily turned off.
- Make sure all necessary cables are securely connected and the power is on for the projector and connected video sources.
- Press the projector's power button to wake it from standby or sleep mode. Also, check if the connected computer is in sleep mode or displaying a blank screen saver.

- If the projector does not respond when you press the control panel buttons, the buttons may be locked for security. Unlock the buttons in the **Control Panel Lock** setting in the projector's **Management** menu or use the remote control to turn on the projector.
- If the projector does not respond when you press any buttons on the projector, an internal error may have occurred in the projector. Contact Epson for help.
- Adjust the **Brightness** setting in the projector's **Image** menu for individual image colors.
  - ☛ **Image > Image Adjustment > Brightness**
- Adjust the brightness of your projector's light source.
  - ☛ **Operation > Light Source Brightness Control**
- Make sure the **Messages** setting is set to **On** in the projector's **Display** menu.
- The projector may not be able to project copyrighted videos that you play back on a computer. For more details, see the manual supplied with the computer.
- For images projected with Windows Media Center, reduce the screen size from full screen mode.
- For images projected from applications using Windows DirectX, turn off DirectX functions.

## ▶▶ Related Links

- "Projector Administration Settings - Management Menu" [p.207](#)
- "Image Quality Settings - Image Menu" [p.193](#)
- "Projector Feature Settings - Operation Menu" [p.204](#)
- "Projector Display Settings - Display Menu" [p.202](#)
- "Unlocking the Projector's Buttons" [p.136](#)

---

## Solutions When "No Signal" Message Appears

If the **No Signal** message appears, try the following solutions:



- Press the [Source Search] button and wait a few seconds for an image to appear.
- Turn on the connected computer or video source, and press play to begin your presentation, if necessary.
- Check that all cables required for projection are securely connected.
- If you are projecting from a laptop computer, make sure it is set up to display on an external monitor.
- If necessary, turn off the projector and the connected computer or video source, and then turn them back on.
- If you are projecting from an HDMI source, replace the HDMI cable with a shorter one.

## ► Related Links

- "Displaying From a Windows Laptop" [p.249](#)
- "Displaying From a Mac Laptop" [p.249](#)

## Displaying From a Windows Laptop

If the message **No Signal** is displayed when projecting from a laptop, you need to set up the Windows laptop to display on an external monitor.

- 1** Hold down the Windows key and press **P** on your keyboard at the same time, then click **Duplicate**.
- 2** If the same image is not displayed by the laptop and projector, check the Windows **Display** utility to make sure the external monitor port is enabled and extended desktop mode is disabled.
- 3** If necessary, check your video card settings and set the multiple display option to **Mirror** or **Duplicate**.

## Displaying From a Mac Laptop

If the message **No Signal** is displayed when projecting from a Mac laptop, you need to set up the laptop for mirrored display. (See your laptop manual for details.)

- 1** Open the **System Preferences** utility and select **Displays**.
- 2** Select the **Display** or **Color LCD** option, if necessary.
- 3** Click the **Arrange** or **Arrangement** tab.
- 4** Select **Mirror Displays**.

## Solutions When "Not Supported" Message Appears

If the message **Not supported** is displayed, try the following solutions:

- Make sure the correct input signal is selected in the projector's **Signal I/O** menu.
- Make sure the computer's display resolution does not exceed the projector's resolution and frequency limits. If necessary, select a different display resolution for your computer.
- If you are projecting from an HDMI source, change the **HDMI IN EQ Level** setting in the projector's **Signal I/O** menu. After changing the setting, you may need to restart the projector. Follow the on-screen instructions.
- Change the **HDMI IN EQ Level** setting.
  - ☛ **Signal I/O > HDMI IN EQ Level > HDMI1**
  - ☛ **Signal I/O > HDMI IN EQ Level > HDMI2**

## ► Related Links

- "Input Signal Settings - Signal I/O Menu" [p.196](#)
- "Supported Monitor Display Resolutions" [p.274](#)

## Solutions When Only a Partial Image Appears

If only a partial computer image appears, try the following solutions:

- Make sure you selected the correct **Screen Type** setting in the projector's **Installation** menu for the screen you are using.  
If there are margins between the edge of the image and the projected screen frame, adjust the position of the image.
- Make sure the **Scale** setting is turned off in the projector's **Image** menu.
- Try adjusting the image position using the **Screen Position** setting.  
☛ **Installation > Screen Position**
- Change the **Aspect** setting in the projector's **Image** menu to select a different image aspect ratio.
- Change the **Blanking** setting in the projector's **Installation** menu so that the image appears as you expect.
- If you zoomed into or out of the image using the [E-Zoom] buttons, press the [Esc] button to return to the original image size.
- Check your computer display settings to disable dual display and set the resolution within the projector's limits.
- Check the resolution assigned to your presentation files to see if they are created for a different resolution.
- When projecting in Content Playback mode, make sure you are using the appropriate **Overlay Effect** settings.  
☛ **Operation > Content Playback > Overlay Effect**
- Make sure you selected the correct **Projection** setting in the projector's **Installation** menu.

### ► Related Links

- "Projector Installation Settings - Installation Menu" [p.198](#)
- "Adjusting the Image Position Using Screen Position" [p.56](#)
- "Image Quality Settings - Image Menu" [p.193](#)
- "Supported Monitor Display Resolutions" [p.274](#)

- "Adding Effects to Your Projected Image" [p.108](#)

## Solutions When the Image Contains Noise or Static

If the projected image contains electronic interference (noise) or static, try the following solutions:

- Check the cables connecting your computer or video source to the projector. They should be:
  - Separated from the power cord to prevent interference
  - Securely connected at both ends
  - Not connected to an extension cable
- Adjust the **Noise Reduction** and **MPEG Noise Reduction** settings in the projector's **Image** menu.  
☛ **Image > Image Enhancement > Noise Reduction**  
☛ **Image > Image Enhancement > MPEG Noise Reduction**
- Select a computer video resolution and refresh rate that are compatible with the projector.
- If you adjusted the image shape using the projector controls, try decreasing the **Sharpness** setting in the projector's **Image** menu to improve image quality.
- If you connected an extension power cable, try projecting without it to see if it caused interference in the signal.
- Make sure you selected the correct **Video Range** or **EDID** setting in the projector's **Signal I/O** menu, if available for your image source.
- When interlaced signals are input, line doubler processing is not performed, so the projected image may flicker. We recommend that interlaced signals be progressively converted using an external device before being input.

### ► Related Links

- "Image Quality Settings - Image Menu" [p.193](#)
- "Supported Monitor Display Resolutions" [p.274](#)

- "Input Signal Settings - Signal I/O Menu" [p.196](#)

---

## Solutions When the Image is Fuzzy or Blurry

If the projected image is fuzzy or blurry, try the following solutions:

- Display a test pattern and use it to adjust the image focus using the focus ring.
- Position the projector close enough to the screen.
- Position the projector so the keystone adjustment angle is not so wide that it distorts the image.
- Clean the projector lens.



To avoid condensation on the lens after bringing the projector in from a cold environment, let the projector warm up to room temperature before using it.

- Adjust the **Sharpness** setting in the projector's **Image** menu to improve image quality.
- If you are projecting from a computer, use a lower resolution or select a resolution that matches the projector's native resolution.

### ▶▶ Related Links

- "Focusing the Image Using the Focus Ring" [p.76](#)
- "Cleaning the Lens" [p.232](#)
- "Image Quality Settings - Image Menu" [p.193](#)

---

## Solutions When the Image is not Rectangular

If the projected image is not evenly rectangular, try the following solutions:

- Place the projector directly in front of the center of the screen, facing it squarely, if possible.

- Adjust the H/V-Keystone setting to correct the image shape.
  - ☛ **Multi-Projection > Geometry Correction > H/V-Keystone**
- Adjust the Quick Corner setting to correct the image shape.
  - ☛ **Multi-Projection > Geometry Correction > Quick Corner**
- Adjust the **Curved Surface** setting to correct the image shape projected on a curved surface.
  - ☛ **Multi-Projection > Geometry Correction > Curved Surface Mode > Curved Surface**
- Adjust the **Corner Wall** setting to correct the image shape projected on a curved surface with right angles.
  - ☛ **Multi-Projection > Geometry Correction > Corner Wall Mode > Corner Wall**
- Adjust the **Point Correction** setting to correct slight distortion which occurs partially.
  - ☛ **Multi-Projection > Geometry Correction > Point Correction Mode > Point Correction**

### ▶▶ Related Links

- "Correcting Image Shape with H/V Keystone" [p.62](#)
- "Correcting the Image Shape with Quick Corner" [p.63](#)
- "Correcting Image Shape with Curved Surface Mode" [p.66](#)
- "Correcting Image Shape with Corner Wall Mode" [p.68](#)
- "Correcting Image Shape with Point Correction Mode" [p.71](#)

---

## Solutions When the Image Brightness or Colors are Incorrect

If the projected image is too dark or light, or the colors are incorrect, try the following solutions:

- Select the **Color Mode** setting in the projector's **Image** menu to try different color modes for the image and environment.

- Check your video source settings.
- Adjust the available settings in the projector's **Image** menu for the current input source, such as **Brightness**, **Contrast**, **Tint**, **Color Saturation**, and **RGBCMY**.
  - ☛ **Image > Image Adjustment > Brightness**
  - ☛ **Image > Image Adjustment > Contrast**
  - ☛ **Image > Image Adjustment > Color Saturation**
  - ☛ **Image > Image Adjustment > Tint**
- Make sure you selected the correct **Video Range** or **EDID** setting in the projector's **Signal I/O** menu, if available for your image source.
- Make sure all the cables are securely connected to the projector and your video device. If you connected long cables, try connecting shorter cables.
- Position the projector close enough to the screen.
- When using multiple projectors, make sure the **Light Source Calibration** setting in the projector's **Management** menu is set to the same option on all the projectors and that the projectors have been calibrated recently. If certain projectors are not calibrated recently, the white balance and brightness level may not match the other projectors.

## ► Related Links

- "Adjusting Image Quality (Color Mode)" [p.82](#)
- "Image Quality Settings - Image Menu" [p.193](#)
- "Supported Monitor Display Resolutions" [p.274](#)
- "Input Signal Settings - Signal I/O Menu" [p.196](#)
- "Projector Administration Settings - Management Menu" [p.207](#)

---

## Solutions When Automatic Adjustments are not Applied Correctly

If you have problems with automatic adjustments not being applied correctly, try the following solutions:

- Be sure to wait at least 30 minutes after turning on the projector before performing automatic adjustments. This gives the projector's temperature a chance to stabilize.
  - Check that the camera area is clean.
  - Make sure the cable of the optional external camera is securely connected to the projector.
  - The optional external camera may be defective. Contact Epson for help.
  - Make sure that a powerful spotlight or source of strong natural light is not shining into the projection environment and interfering with automatic adjustments.
  - Check that your image correction and image blending settings are within reasonable ranges. If the projection angle is very large, try turning off the **Geometry Correction** setting or reduce the projection angle. If you are using the **Edge Blending** setting, make sure the blending width is between 15 to 43%.
  - If you see an error message during automatic adjustments, check the error codes in the message.
    - During Screen Matching:
      - 0101: Measurement value error
      - 0102: Measurement failure
      - 0103: Switch camera failure
      - 0104/0105: Model mismatch
      - 0108: Camera error
    - During Color Matching:
      - 0201: Measurement value error
      - 0202: Measurement failure
      - 0203: Switch camera failure
      - 0208: Camera error
- Contact Epson for support for details.

---

## Solutions When Simple Stacking is not Applied Correctly

If you have problems with simple stacking not being applied correctly, try the following solutions:

- Make sure the projectors are placed correctly and connected using a LAN cable.
- Make sure the optional external camera is installed correctly and the cable is securely connected to the projector.
- The optional external camera may be defective. Contact Epson for help.
- Make sure that a powerful spotlight or source of strong natural light is not shining into the projection environment and interfering with simple stacking.
- Resize the projection size.
- If you see an error message during the simple stacking process, check the error codes in the message.
  - 0302: Measurement failure
  - 0306: Geometry correction error
  - 0307/0308: The external camera may be defective, or a communication error has occurred.

Contact Epson for support for details.

---

## Solutions When Simple Blending is not Applied Correctly

If you have problems with simple blending not being applied correctly, try the following solutions:

- Make sure the projectors are placed correctly and connected using a LAN cable.

- Make sure the optional external camera is installed correctly and the cable is securely connected to the projector.
- The optional external camera may be defective. Contact Epson for help.
- Make sure that a powerful spotlight or source of strong natural light is not shining into the projection environment and interfering with simple stacking.
- Resize the projection size.
- If you see an error message during the simple blending process, check the error codes in the message.
  - 0402: Measurement failure
  - 0406: Geometry correction error
  - 0407/0408: The external camera may be defective, or a communication error has occurred.

Contact Epson for support for details.

---

## Solutions When an Afterimage Remains on the Projected Image

If you see an afterimage in the projected image, use the **Refresh Mode** feature to clear it. Select **Refresh Mode > Start** in the projector's **Management** menu.

### ▶▶ Related Links

- "Projector Administration Settings - Management Menu" [p.207](#)

---

## Solutions to Sound Problems

If there is no sound or the volume is too low or high, try the following solutions:

- Adjust the projector's volume settings.
- Press the [A/V Mute] button on the projector or remote control to resume video and audio if they were temporarily stopped.

- Press the [Mute] button on the remote control to resume audio if it was temporarily stopped.
- Check your computer or video source to make sure the volume is turned up and the audio output is set for the correct source.
- Check the audio cable connections between the projector and your video source.
- Make sure any connected audio cables are labeled "No Resistance".
- If you do not hear sound from an HDMI source, set the connected device to PCM output.
- When you are connecting the projector to a Mac using an HDMI cable, make sure your Mac supports audio through the HDMI port. If not, you need to connect an audio cable.
- If the volume for the computer is set to the minimum while the projector is set to the maximum, the noise may be mixed. Turn up the computer's volume and turn down the projector's volume. (When you use Epson iProjection (Windows/Mac).)

## ► Related Links

- "Controlling the Volume with the Volume Buttons" [p.92](#)
- "Projector Connections" [p.35](#)

---

## Solutions When Image File Names are not Displayed Correctly in PC Free

If any file names are longer than the display area or include unsupported symbols, the file names are shortened or changed in PC Free. Shorten or change the file name.

## ► Related Links

- "Projecting a PC Free Presentation" [p.99](#)

---

## Solutions When You Cannot Project Images Using the PC Free Feature

If you cannot project images using the PC Free feature, try the following solutions:

- If you are using a USB device with a slow transfer speed, you may not be able to project movies correctly.

## ► Related Links

- "Supported PC Free File Types" [p.99](#)

Check the solutions in these sections if you have problems operating the projector or remote control.

## ▶▶ Related Links

- "Solutions to Projector Power or Shut-Off Problems" [p.255](#)
- "Solutions to Problems with the Remote Control" [p.255](#)
- "Solutions to Password Problems" [p.256](#)
- "Solution When "The Battery that Saves Your Clock Settings is Running Low" Message Appears" [p.256](#)

---

## Solutions to Projector Power or Shut-Off Problems

If the projector does not turn on when you press the power button or it turns off unexpectedly, try the following solutions:

- Make sure the power cord is securely connected to the projector and to a working electrical outlet.
- If the power button on the remote control does not turn on the projector, check its batteries and make sure at least one of the remote receivers are available in the **Remote Receiver** setting in the projector's **Installation** menu.
- The projector's buttons may be locked for security. Unlock the buttons in the **Control Panel Lock** setting in the projector's **Management** menu or use the remote control to turn on the projector.
- If the projector's light source turns off unexpectedly, it may have entered sleep mode after a period of inactivity. Perform any operation to wake the projector. To turn off sleep mode, set the **Sleep Mode** setting to **Off** in the projector's **Operation** menu.
- If the projector's light source turns off unexpectedly, the A/V mute timer may be enabled. Set the **A/V Mute Timer** setting to **Off** in the projector's **Operation** menu.

☛ **Operation** > **A/V Mute Settings** > **A/V Mute Timer**

- If the projector's light source turns off, the status indicator is flashing, and the temp (temperature) indicator is lit, the projector has overheated and turned off.
- The cooling fans may run in standby status depending on the projector settings. Also, when the projector wakes from standby status, the fans may cause an unexpected noise. This is not a malfunction.
- The power cord may be defective. Disconnect the cord and contact Epson for help.

## ▶▶ Related Links

- "Projector Administration Settings - Management Menu" [p.207](#)
- "Projector Feature Settings - Operation Menu" [p.204](#)
- "Unlocking the Projector's Buttons" [p.136](#)
- "Projector Indicator Status" [p.244](#)

---

## Solutions to Problems with the Remote Control

If the projector does not respond to remote control commands, try the following solutions:

- Check that the remote control batteries are installed correctly and have power. If necessary, replace the batteries.
- Make sure you are operating the remote control within the reception angle and range of the projector.
- Make sure the projector is not warming up or shutting down.
- Check to see if a button on the remote control is stuck down, causing it to enter sleep mode. Release the button to wake the remote control up.
- Strong fluorescent lighting, direct sunlight, or infrared device signals may be interfering with the projector's remote receivers. Dim the lights or move the projector away from the sun or interfering equipment.
- Make sure at least one of the remote receivers are available in the **Remote Receiver** setting in the projector's **Installation** menu.

- If the **Remote Receiver** setting is disabled, hold down the [Menu] button on the remote control for at least 15 seconds to reset the setting to its default.
- If you assigned an ID number to the projector to operate multiple projectors from the remote control, you may need to check or change the ID setting.
- Press the 0 (zero) button on the remote control while holding down the [ID] button. By selecting 0 on the remote control, you can operate all of the projectors regardless of the projector ID settings.
- If you lose the remote control, you can order another one from Epson.

## ► Related Links

- "Remote Control Operation" [p.45](#)
- "Installing Batteries in the Remote Control" [p.44](#)
- "Projector Installation Settings - Installation Menu" [p.198](#)

---

## Solutions to Password Problems

If you cannot enter or remember a password, try the following solutions:

- If you have entered an incorrect password too many times and see a message displaying a request code, write down the code and contact Epson for help. Provide the request code and proof of ownership for assistance in unlocking the projector.
- If you lose the remote control you cannot enter a password. Order a new one from Epson.

### Attention

If you perform **Reset All** or **Reset Network Settings** in the projector's menu, all of the passwords that have been set for the **Network** menu are also reset and you need to set them again. To prevent the passwords from being reset by unauthorized users, set **Network** to **On** in the **Password Protection** menu.

---

## Solution When "The Battery that Saves Your Clock Settings is Running Low" Message Appears

If the following message is displayed, contact Epson for help:

The battery that saves your clock settings is running low.



Check the solutions in these sections if you have problems using the projector on a network.

## ▶▶ Related Links

- "Solutions When Wireless Authentication Fails" [p.257](#)
- "Solutions When You Cannot Access the Projector Through the Web" [p.257](#)
- "Solutions When Network Alert E-Mails are not Received" [p.258](#)
- "Solutions When the Image Contains Static During Network Projection" [p.258](#)
- "Solutions When You Cannot Connect Using Miracast" [p.258](#)
- "Solutions When the Image or Sound Contains Static During Miracast Connection" [p.259](#)
- "Solutions When You Cannot Connect Using AirPlay" [p.259](#)
- "Solutions When the Image or Sound Contains Static During AirPlay Connection" [p.259](#)
- "Solutions When You Cannot Receive Shared Images" [p.259](#)

## Solutions When Wireless Authentication Fails

If you are having trouble with the authentication, try the following solutions:

- If the wireless settings are correct, but authentication fails, you may need to update the **Date & Time** settings in the projector's **Management** menu.
- Check the **Security** settings in the projector's **Network** menu.  
☛ **Network > Network Settings > Wireless LAN > Security**
- If the access point security is WPA3-EAP, change the access point setting to WPA2/WPA3-EAP.

## ▶▶ Related Links

- "Projector Network Settings - Network Menu" [p.211](#)

## Solutions When You Cannot Access the Projector Through the Web

If you are unable to access the projector through a Web browser, make sure you are using the correct ID and password.

- Make sure you use the following user IDs. (You cannot change the user IDs.)
  - To access the **Basic Control** option, enter **EPSONREMOTE**.
  - To access other options and save settings, enter **EPSONWEB**.
- For the password, enter the password set in the projector's **Network** menu. No password is set by default.
- When connecting to the access point, make sure you have access to the network the projector is on.
- If your Web browser is set up to connect via a proxy server, the **Epson Web Control** screen cannot be displayed. Make settings for a connection without using a proxy server.
- If you set the **Standby Mode** setting to **Normal** in the projector's **Operation** menu, make sure the network device is turned on. After turning on the network device, turn on the projector. If you are connecting wirelessly, connect to devices over a wireless network access point.



The user ID and password are case sensitive.

## ▶▶ Related Links

- "Projector Feature Settings - Operation Menu" [p.204](#)

## Solutions When Network Alert E-Mails are not Received

If you do not receive an e-mail alerting you to problems with a projector over the network, try the following solutions:

- Make sure the projector is turned on and connected to the network correctly. (If an error shuts down the projector, the email may not be delivered.)
- Make sure you set up the projector e-mail alert settings correctly in the projector's network **Mail Notification** menu or in the network software.
- Set the **Standby Mode** setting to **Normal** in the projector's **Operation** menu so that the network software can monitor the projector in standby mode. If you are connecting wirelessly, connect to devices over a wireless network access point.

### ▶▶ Related Links

- "Network Menu - Mail Notification Menu" [p.216](#)
- "Installing Batteries in the Remote Control" [p.44](#)

## Solutions When the Image Contains Static During Network Projection

If the projected image contains static during network projection, try the following solutions:

- Check for any obstacles between the access point, the computer, the mobile device, and the projector, and change their positions to improve communication.
- Make sure that the access point, the computer, the mobile device and the projector are not too far apart. Move them closer together and try to connect again.

- Check for interference from other equipment, such as a Bluetooth device or microwave. Move the interfering device farther away or expand your wireless bandwidth.
- Reduce the number of connected devices if the connection speed declines.

## Solutions When You Cannot Connect Using Miracast

If you are unable to connect to the projector using Miracast, try the following solutions:

- Check the projector's settings.
  - Set the **Simple AP** setting to **On**.  
☛ **Network > Network Settings > Simple AP**
  - Set the **Miracast** setting to **On**, and then restart the projector.  
☛ **Network > Network Configuration > Network Projection > Miracast**
  - Select the **Miracast** setting to **Off**, select **On** again, and then restart the projector.  
☛ **Network > Network Configuration > Network Projection > Miracast**
- Check the mobile device's settings.
  - Make sure the settings on the mobile Miracast device are correct.
  - When connecting again immediately after disconnecting, it may take some time until the connection is established. Reconnect after waiting for a while.
  - Restart the mobile device.
  - Once you have connected using Miracast, the projector connection information may be recorded on the mobile device. However, you may not be able to reconnect to the projector from the recorded information. Select the projector from the list of available devices.

### ▶▶ Related Links

- "Network Menu - Network Settings Menu" [p.212](#)

- "Network Menu - Network Projection Settings" [p.219](#)

---

## Solutions When the Image or Sound Contains Static During Miracast Connection

If the projected image or sound contains static when connecting using Miracast, try the following solutions:

- Avoid covering the Wi-Fi antenna of the mobile device.
- If you use a Miracast connection and an internet connection at the same time, the image may stop or contain noise. Disconnect the internet connection to expand your wireless bandwidth and improve the connection speed of the mobile device.
- Make sure the projection contents meet the Miracast requirements.
- Depending on the settings of the mobile device, the connection may be lost when the device enters power saving mode. Check the electrical power saving settings on the mobile device.
- Update to the latest version of the wireless driver or firmware on the mobile device.

---

## Solutions When You Cannot Connect Using AirPlay

If you cannot connect using AirPlay, check the following solutions.

- Check the projector's settings.
  - Check that your Apple device and the projector are using the same network connection.
  - Set AirPlay to On from the AirPlay and HomeKit settings screen.
- Restart the projector.
- Check that the settings on your Apple device are correct.

- If the date and time are not correctly set on the projector, the AirPlay connection may be disconnected while projecting.  
Set the correct date and time in **Date & Time** and **Daylight Saving Time** from the **Management** menu.
- Check if the network you are using is configured to block specific network port communications.

---

## Solutions When the Image or Sound Contains Static During AirPlay Connection

If the video or audio is distorted when using AirPlay, check the following solutions.

- Check for obstacles between the access point, Apple device, and projector, and change their positions to improve the signal strength.
- Check that the Wi-Fi antenna part of your Apple device is not covered.
- Check that the content is suitable for streaming or mirroring using AirPlay.
- Depending on your Apple device settings, the connection may be lost during power saving. Check the power saving settings on your Apple device.
- Update your Apple device software to the latest version.

---

## Solutions When You Cannot Receive Shared Images

If you cannot receive shared images from other projectors, try the following solutions:

- Connect the projector to the same network as the projector that is sharing images.
- Make sure the **Screen Sharing** setting is set to **On**.
  -  **Network > Network Settings > Network Projection > Screen Sharing**

- Make sure that no other device is connecting to the projector using the Epson iProjection software.
- If the firmware version amongst the projectors sharing the screen is not the same, you may need to update the projector's firmware to share your screen.

▶ **Related Links**

- "Network Menu - Network Projection Settings" [p.219](#)

If you cannot play back a playlist correctly, try the following solutions:

- Make sure **Content Playback** is set to **On** in the projector's **Operation** menu.
- Make sure the USB flash drive contains a playlist.
- Make sure the USB flash drive is directly connected to the projector. Do not use a multi-card reader or a USB hub to expand a USB port.
- If the USB flash drive is partitioned, you may not be able to play back playlists. Delete all of the partitions before saving the playlists on the USB flash drive.
- Do not share a playlist between projectors that are different in resolution. Color and shape effects added by using **Overlay Effect** in the projector's **Operation** menu may not be reproduced correctly.

## ► **Related Links**

- "Multiple Projector Operation Settings - Multi-Projection Menu" [p.200](#)

If you cannot operate the connected devices using the HDMI Link features, try the following solutions:

- Make sure the cable meets the HDMI CEC standard.
- Make sure the connected device meets the HDMI CEC standard. See the documentation supplied with the device for more information.
- Check that all cables required for HDMI Link are securely connected.
- Make sure the connected devices are turned on and in standby status. See the documentation supplied with the device for more information.
- If you connected a speaker, set it to PCM output.
- If you connect a new device or change the connection, set the CEC function for the connected device again and restart the device.
- Do not connect 4 or more multi-media players. You can connect up to 3 multi-media players that meet the HDMI CEC standard at the same time.
- If the device does not appear in the Device Connections list, it does not meet the HDMI CEC standards. Connect a different device.

# Appendix

Check these sections for the technical specifications and important notices about your product.

## ▶ **Related Links**

- "Optional Accessories and Replacement Parts" [p.264](#)
- "Screen Size and Projection Distance" [p.266](#)
- "Supported Monitor Display Resolutions" [p.274](#)
- "Projector Specifications" [p.275](#)
- "External Dimensions" [p.278](#)
- "Supported Features for Epson Projector Content Manager" [p.281](#)
- "List of Safety Symbols and Instructions" [p.282](#)
- "Laser Safety Information" [p.284](#)
- "Notices" [p.286](#)

The following optional accessories and replacement parts are available. Please purchase these products as and when needed.

The following list of optional accessories and replacement parts is current as of January 2025.

Details of accessories are subject to change without notice and availability may vary depending on the country of purchase.

## ▶ Related Links

- "Screens" [p.264](#)
- "Mounts" [p.264](#)
- "For Wireless Connection" [p.264](#)
- "External Devices" [p.265](#)
- "Replacement Parts" [p.265](#)

---

## Screens

### 80" Mobile X-Type Screen ELPSC21

Portable X-type screens. (aspect ratio 16:9)

### 70" portable screen ELPSC23

### 80" portable screen ELPSC24

### 90" portable screen ELPSC25

Portable roll-type screens. (aspect ratio 16:10)

### Multi Aspect Screen ELPSC26/ES3000

Portable multi-aspect screen.

### 60" portable screen ELPSC27

### 80" portable screen ELPSC28

### 100" portable screen ELPSC29

Portable roll-type screens. (aspect ratio 4:3)

### 53" portable screen ELPSC30

### 64" portable screen ELPSC31

Portable magnetic screens. (aspect ratio 4:3)

### 50" portable screen ELPSC32/ES1000

A compact screen that can be carried easily. (aspect ratio 4:3)

---

## Mounts

### Ceiling mount ELPMB22

### Ceiling mount (Low profile) ELPMB30

Use when installing the projector on a ceiling.

### Safety Wire Set ELPWR01

Use when connecting the projector to the installation mount to prevent the projector from falling down.

### Ceiling pipe (450 mm) ELPFP13

### Ceiling pipe (700 mm) ELPFP14

Use when installing the projector on a high ceiling.



Special expertise is required to suspend the projector from a ceiling.  
Contact Epson for help.

---

## For Wireless Connection

### Wireless LAN module ELPAP11

Use this to project images from a computer via a wireless communication.

### Wireless Presentation System ELPWP20

Use when directly connecting to Windows/Mac computers and projecting images wirelessly. Includes two wireless transmitters (ELPWT01) and one base unit (ELPBU01).



---

## External Devices

### **Document Camera ELPDC30**

### **Document Camera ELPDC21**

### **Document Camera ELPDC13**

### **Document Camera ELPDC07**

Use when displaying image such as books or printed materials.

### **HDBaseT Transmitter ELPHD01**

Use when sending an HDMI signal over a long distance. (HDCP 2.2 is not supported)

### **External Speaker ELPSP02**

External self-powered speaker.

### **External Camera ELPEC01**

Use this to automatically adjust images projected from multiple projectors.

### **Cable Cover ELPCC07W/ELPCC07B**

Use this to hide the attached cables from view when suspending the projector from a ceiling.

---

## Replacement Parts

### **Air filter ELPAF65**

Use as a replacement for used air filters.

Check the table here to determine how far to place the projector from the screen based on the size of the projected image.

The projection distances are approximate values.

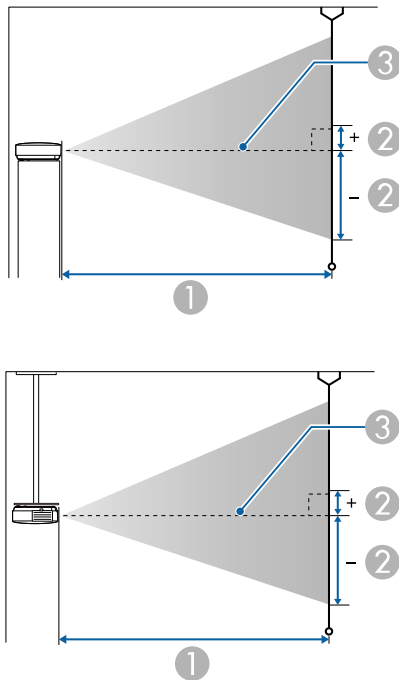

- ① Projection distance (cm)
- ② Distance from the center of the lens to the base of the screen (This changes depending on the setting for vertical lens shift.) (cm)
- ③ Center of lens

EB-L890E/EB-L895E/EB-L690E/EB-L890U/EB-L895U/EB-L790U/EB-L690U

16:10 screen size		①		②
		Minimum (Wide) to Maximum (Tele)		Vertical Lens Shift Bottom to Top
inch	cm			
50	108 × 67	144	235	-67 - 0
60	129 × 81	174	283	-81 - 0
70	151 × 94	204	331	-94 - 0
80	172 × 108	233	378	-108 - 0
100	215 × 135	292	474	-135 - 0
120	258 × 162	351	569	-162 - 0
150	323 × 202	440	713	-202 - 0
200	431 × 269	588	951	-269 - 0
300	646 × 404	884	1429	-404 - 0
500	1077 × 673	1476	2384	-673 - 0

4:3 screen size		①		②
		Minimum (Wide) to Maximum (Tele)		Vertical Lens Shift Bottom to Top
inch	cm			
45	91 × 69	147	240	-69 - 0
50	102 × 76	164	267	-76 - 0
60	122 × 91	197	321	-91 - 0
80	163 × 122	264	429	-122 - 0
100	203 × 152	331	537	-152 - 0
120	244 × 183	398	645	-183 - 0
150	305 × 229	499	807	-229 - 0
200	406 × 305	666	1077	-305 - 0
300	610 × 457	1001	1618	-457 - 0
400	813 × 610	1336	2158	-610 - 0
441	896 × 672	1473	2380	-672 - 0

16:9 screen size		①		②
		Minimum (Wide) to Maximum (Tele)		Vertical Lens Shift Bottom to Top
inch	cm			
49	108 × 61	145	237	-64 - 3
50	111 × 62	148	242	-66 - 3
60	133 × 75	179	291	-79 - 4
80	177 × 100	240	389	-105 - 6
100	221 × 125	301	487	-131 - 7
120	266 × 149	361	585	-158 - 8
150	332 × 187	453	733	-197 - 10
200	443 × 249	605	978	-263 - 14
300	664 × 374	909	1469	-394 - 21
400	886 × 498	1213	1959	-526 - 28
486	1076 × 605	1474	2381	-639 - 34

16:6 screen size		①		②
		Minimum (Wide) to Maximum (Tele)		Vertical Lens Shift Bottom to Top
inch	cm			
46	109 × 41	147	239	-55 - 14
50	119 × 45	160	260	-59 - 15
60	143 × 54	192	313	-71 - 18
80	190 × 71	258	418	-95 - 24
100	238 × 89	323	524	-119 - 30
120	285 × 107	388	629	-143 - 36
150	357 × 134	486	787	-178 - 45
200	476 × 178	650	1051	-238 - 59
300	713 × 268	976	1578	-357 - 89
400	951 × 357	1303	2105	-476 - 119
452	1075 × 403	1473	2379	-537 - 134

21:9 screen size		①		②
		Minimum (Wide) to Maximum (Tele)		Vertical Lens Shift Bottom to Top
inch	cm			
47	110 × 47	147	240	-58 - 11
50	117 × 50	157	255	-61 - 11
60	140 × 60	189	307	-74 - 14
80	187 × 80	253	410	-98 - 18
100	233 × 100	317	514	-123 - 23
120	280 × 120	381	617	-148 - 28
150	350 × 150	477	773	-184 - 34
200	467 × 200	638	1031	-246 - 46
300	700 × 300	958	1549	-369 - 69
400	934 × 400	1279	2066	-492 - 92
461	1076 × 461	1475	2382	-567 - 106

EB-L790SE/EB-L795SE/EB-L790SU/EB-L690SU/EB-L695SU

16:10 screen size		①		②
inch	cm	Minimum (Wide) to Maximum (Tele)		Vertical Lens Shift Bottom to Top
60	129 × 81	102	175	-81 - 0
70	151 × 94	119	204	-94 - 0
80	172 × 108	137	234	-108 - 0
90	194 × 121	154	264	-121 - 0
100	215 × 135	172	294	-135 - 0
110	237 × 148	189	324	-148 - 0
150	323 × 202	259	443	-202 - 0
200	431 × 269	346	592	-269 - 0
300	646 × 404	521	890	-404 - 0
400	862 × 538	695	1189	-538 - 0

4:3 screen size		①		②
inch	cm	Minimum (Wide) to Maximum (Tele)		Vertical Lens Shift Bottom to Top
53	108 × 81	102	175	-81 - 0
60	122 × 91	116	198	-91 - 0
70	142 × 107	135	232	-107 - 0
80	163 × 122	155	266	-122 - 0
90	183 × 137	175	300	-137 - 0
100	203 × 152	195	333	-152 - 0
110	224 × 168	214	367	-168 - 0
120	244 × 183	234	401	-183 - 0
200	406 × 305	392	671	-305 - 0
300	610 × 457	590	1009	-457 - 0
353	717 × 538	694	1188	-538 - 0

16:9 screen size		①		②
		Minimum (Wide) to Maximum (Tele)		Vertical Lens Shift Bottom to Top
inch	cm			
58	128 × 72	101	174	-76 - 4
60	133 × 75	105	180	-79 - 4
70	155 × 87	123	210	-92 - 5
80	177 × 100	141	241	-105 - 6
90	199 × 112	159	272	-118 - 6
100	221 × 125	177	302	-131 - 7
110	244 × 137	194	333	-145 - 8
120	266 × 149	212	364	-158 - 8
200	443 × 249	356	609	-263 - 14
300	664 × 374	535	915	-394 - 21
389	861 × 484	695	1188	-511 - 27

16:6 screen size		①		②
		Minimum (Wide) to Maximum (Tele)		Vertical Lens Shift Bottom to Top
inch	cm			
54	128 × 48	101	174	-64 - 16
60	143 × 54	113	193	-71 - 18
70	166 × 62	132	226	-83 - 21
80	190 × 71	151	259	-95 - 24
90	214 × 80	171	292	-107 - 27
100	238 × 89	190	325	-119 - 30
110	262 × 98	209	358	-131 - 33
120	285 × 107	228	391	-143 - 36
200	476 × 178	382	654	-238 - 59
300	713 × 268	575	984	-357 - 89
362	861 × 323	695	1188	-430 - 108

21:9 screen size		①		② Vertical Lens Shift Bottom to Top
		Minimum (Wide) to Maximum (Tele)		
inch	cm			
55	128 × 55	101	174	-68 - 13
60	140 × 60	111	190	-74 - 14
70	163 × 70	130	222	-86 - 16
80	187 × 80	148	254	-98 - 18
90	210 × 90	167	287	-111 - 21
100	233 × 100	186	319	-123 - 23
110	257 × 110	205	351	-135 - 25
120	280 × 120	224	384	-148 - 28
200	467 × 200	375	642	-246 - 46
300	700 × 300	564	966	-369 - 69
369	861 × 369	695	1189	-454 - 85

EB-L690SE/EB-L695SE

16:10 screen size		①		② Vertical Lens Shift Bottom to Top
		Minimum (Wide) to Maximum (Tele)		
inch	cm			
80	172 × 108	86	123	-108 - 0
90	194 × 121	97	139	-121 - 0
100	215 × 135	109	154	-135 - 0
110	237 × 148	120	170	-148 - 0
120	258 × 162	131	186	-162 - 0
150	323 × 202	165	233	-202 - 0
200	431 × 269	221	312	-269 - 0
300	646 × 404	334	469	-404 - 0
400	862 × 538	446	627	-538 - 0
500	1077 × 673	558	784	-673 - 0

4:3 screen size		①		②
inch	cm	Minimum (Wide) to Maximum (Tele)		Vertical Lens Shift Bottom to Top
71	144 × 108	87	123	-108 - 0
80	163 × 122	98	139	-122 - 0
90	183 × 137	111	157	-137 - 0
100	203 × 152	123	175	-152 - 0
110	224 × 168	136	193	-168 - 0
120	244 × 183	149	211	-183 - 0
150	305 × 229	187	264	-229 - 0
200	406 × 305	251	353	-305 - 0
300	610 × 457	378	532	-457 - 0
400	813 × 610	505	710	-610 - 0
441	896 × 672	558	783	-672 - 0

16:9 screen size		①		②
inch	cm	Minimum (Wide) to Maximum (Tele)		Vertical Lens Shift Bottom to Top
78	173 × 97	86	123	-103 - 5
80	177 × 100	89	126	-105 - 6
90	199 × 112	100	142	-118 - 6
100	221 × 125	112	159	-131 - 7
110	244 × 137	123	175	-145 - 8
120	266 × 149	135	191	-158 - 8
150	332 × 187	170	240	-197 - 10
200	443 × 249	227	321	-263 - 14
300	664 × 374	343	482	-394 - 21
400	886 × 498	459	644	-526 - 28
486	1076 × 605	558	783	-639 - 34



16:6 screen size		①		②
		Minimum (Wide) to Maximum (Tele)		Vertical Lens Shift Bottom to Top
inch	cm			
73	174 × 65	87	124	-87 - 22
80	190 × 71	96	136	-95 - 24
90	214 × 80	108	153	-107 - 27
100	238 × 89	120	171	-119 - 30
110	262 × 98	133	188	-131 - 33
120	285 × 107	145	205	-143 - 36
150	357 × 134	182	258	-178 - 45
200	476 × 178	245	345	-238 - 59
300	713 × 268	369	518	-357 - 89
400	951 × 357	493	692	-476 - 119
452	1075 × 403	557	783	-537 - 134

21:9 screen size		①		②
		Minimum (Wide) to Maximum (Tele)		Vertical Lens Shift Bottom to Top
inch	cm			
74	173 × 74	86	123	-91 - 17
80	187 × 80	94	133	-98 - 18
90	210 × 90	106	150	-111 - 21
100	233 × 100	118	168	-123 - 23
110	257 × 110	130	185	-135 - 25
120	280 × 120	142	202	-148 - 28
150	350 × 150	179	253	-184 - 34
200	467 × 200	240	338	-246 - 46
300	700 × 300	362	509	-369 - 69
400	934 × 400	484	680	-492 - 92
461	1076 × 461	558	784	-567 - 106

See the *Specifications* for detailed information on compatible refresh rates and resolutions for each compatible video display format.

Product name	EB-L890E/EB-L895E/EB-L790SE/EB-L795SE/EB-L690SE/EB-L695SE/EB-L690E/EB-L890U/EB-L895U/EB-L790U/EB-L790SU/EB-L690U/EB-L690SU/EB-L695SU
Dimensions	440 (W) × 122 (H) × 304 (D) mm (not including raised section)
LCD panel size	0.67"
Display method	3LCD
Number of pixels	WUXGA (1,920 (W) × 1,200 (H) dots) × 3
Screen Resolution	2,304,000 pixels (1,920 × 1,200 × 3)
Focus adjustment	Manual
Zoom adjustment	EB-L890E/EB-L895E/EB-L690E/EB-L890U/EB-L895U/EB-L790U/EB-L690U: 1.0 to 1.6 (Optical zoom) EB-L790SE/EB-L795SE/EB-L790SU/EB-L690SU/EB-L695SU: 1.0 to 1.7 (Optical zoom) EB-L690SE/EB-L695SE: 1.0 to 1.4 (Optical zoom)
Lens Shift	Manual Maximum vertical direction: Approx. ±50% Maximum horizontal direction: Approx. ±20%
Light source	Laser diode

Light source output power	EB-L890E/EB-L895E/EB-L790SE/EB-L795SE/EB-L890U/EB-L895U/EB-L790SU: Up to 177 W EB-L690E/EB-L790U/EB-L690U/EB-L690SU/EB-L695SU: Up to 153 W EB-L690SE/EB-L695SE: Up to 165 W
Wavelength	449 to 461 nm
Light source operation time *	Normal or Quiet Light Source Mode: Up to about 20,000 hours Extended Light Source Mode: Up to about 30,000 hours
Max. audio output	EB-L890E/EB-L895E/EB-L790SE/EB-L795SE/EB-L690E/EB-L890U/EB-L895U/EB-L790U/EB-L790SU/EB-L690U/EB-L690SU/EB-L695SU: 10 W EB-L690SE/EB-L695SE: -
Laser class (internal laser light source)	Class 4
Speaker	EB-L890E/EB-L895E/EB-L790SE/EB-L795SE/EB-L690E/EB-L890U/EB-L895U/EB-L790U/EB-L790SU/EB-L690U/EB-L690SU/EB-L695SU: 1 EB-L690SE/EB-L695SE: -
Power supply	EB-L890E/EB-L895E/EB-L790SE/EB-L795SE/EB-L890U/EB-L895U/EB-L790SU: 100-240V AC±10% 50/60Hz 4.8 - 2.1 A EB-L690SE/EB-L695SE/EB-L690E/EB-L790U/EB-L690U/EB-L690SU/EB-L695SU: 100-240V AC±10% 50/60Hz 4.4 - 2.0 A

Operating power consumption (100 to 120 V area)	<b>EB-L890E/EB-L895E/EB-L790SE/EB-L795SE/EB-L890U/EB-L895U/EB-L790SU:</b> Light Source Mode: Normal, Custom: 470 W Light Source Mode: Quiet: 341 W Light Source Mode: Extended: 321 W <b>EB-L690SE/EB-L695SE:</b> Light Source Mode: Normal, Custom: 432 W Light Source Mode: Quiet: 313 W Light Source Mode: Extended: 295 W <b>EB-L690E/EB-L790U/EB-L690U/EB-L690SU/EB-L695SU:</b> Light Source Mode: Normal, Custom: 415 W Light Source Mode: Quiet: 305 W Light Source Mode: Extended: 287 W
Operating power consumption (220 to 240 V area)	<b>EB-L890E/EB-L895E/EB-L790SE/EB-L795SE/EB-L890U/EB-L895U/EB-L790SU:</b> Light Source Mode: Normal, Custom: 450 W Light Source Mode: Quiet: 330 W Light Source Mode: Extended: 310 W <b>EB-L690SE/EB-L695SE:</b> Light Source Mode: Normal, Custom: 415 W Light Source Mode: Quiet: 303 W Light Source Mode: Extended: 286 W <b>EB-L690E/EB-L790U/EB-L690U/EB-L690SU/EB-L695SU:</b> Light Source Mode: Normal, Custom: 399 W Light Source Mode: Quiet: 295 W Light Source Mode: Extended: 278 W
Standby power consumption	When <b>Standby Mode</b> is set to <b>Wired LAN Communication</b> : 2.4 W When <b>Standby Mode</b> is set to <b>ECO</b> : 0.3 W (100 to 120 V area), 0.4 W (220 to 240 V area)

Operating altitude	Altitude 0 to 3,048 m
Operating temperature **	Altitude of 0 to 2,286 m: 0 to +45°C (Humidity of 20 to 80%, No condensation) Altitude of 2,287 to 3,048 m: 0 to +40°C (Humidity of 20 to 80%, No condensation)
Storage temperature	-10 to +60°C (No condensation)
Mass	<b>EB-L890E/EB-L895E/EB-L790SE/EB-L795SE/EB-L890U/EB-L895U/EB-L790SU/EB-L690SU/EB-L695SU:</b> Approx. 9.5 kg <b>EB-L690E/EB-L790U/EB-L690U:</b> Approx. 9.0 kg <b>EB-L690SE/EB-L695SE:</b> Approx. 10.0 kg

\* Approximate time until the light source brightness decreases to half of its original value. (Assuming the projector is being used in an environment containing airborne particles of 0.04 to 0.2 mg/m<sup>3</sup>. This is an approximate guide only and may change depending on the projector's usage and surroundings.)

\*\* Light source brightness automatically dims if the surrounding temperature gets too high. (Approximately 35°C at an altitude of 0 to 2,286 m, and approximately 30°C at an altitude of 2,287 to 3,048 m; however, this may vary depending on the surrounding environment.)

This product is also designed for IT power distribution system with phase-to-phase voltage 230V.

The rating label is attached on the bottom surface of the projector.

This product is certified for wireless communication in Zambia. See the following URL for the certification number.

[https://download2.ebz.epson.net/sec\\_pubs\\_visual/zicta/](https://download2.ebz.epson.net/sec_pubs_visual/zicta/)

►► **Related Links**

- "Connector Specifications" p.277

## Connector Specifications

Audio Out port	1	Stereo mini pin jack Output Level: 2Vrms Output Impedance: 100 ohm
HDMI1 port	1	HDMI (Audio is only supported by PCM)
HDMI2 port	1	HDMI (Audio is only supported by PCM)
HDMI Out port	1	HDMI (Audio is only supported by PCM)
USB-A ports	2	USB connector (Type A for 5V $\pm$ 2.0A and for 5V $\pm$ 900mA)
Service port	1	USB connector (Type B)
LAN port	1	RJ-45
HDBaseT port	1	RJ-45
RS-232C port	1	Mini D-Sub 9-pin (male)



- USB-A and USB-B port supports USB 2.0. However, USB ports are not guaranteed to operate all devices that support USB.
- USB-B port does not support USB 1.1.

EB-L890E/EB-L895E/EB-L690E/EB-L890U/EB-L895U/EB-L790U/EB-L690U

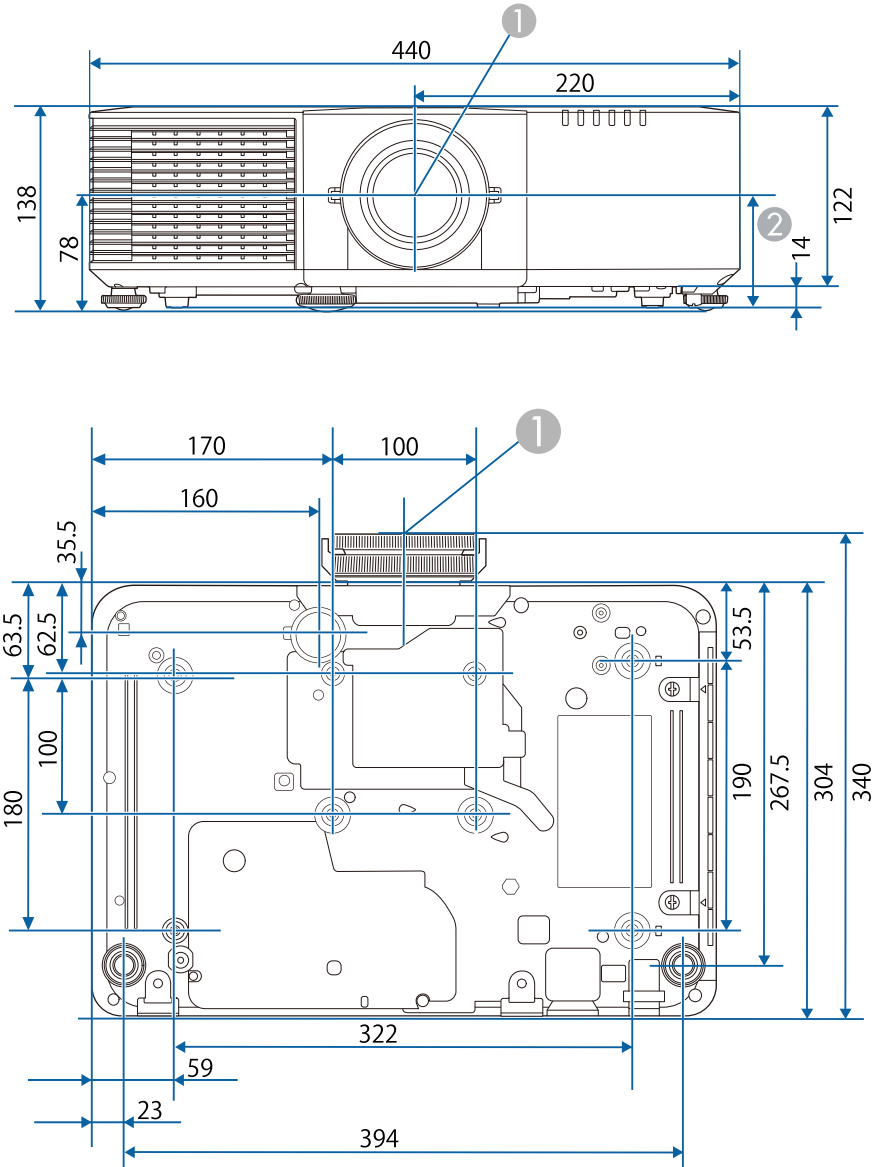

- ① Center of lens
- ② Distance from center of lens to suspension bracket fixing point: 76 mm

EB-L790SE/EB-L795SE/EB-L790SU/EB-L690SU/EB-L695SU

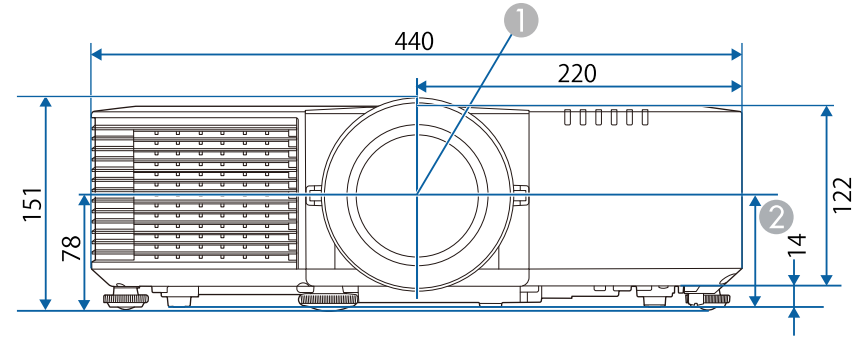

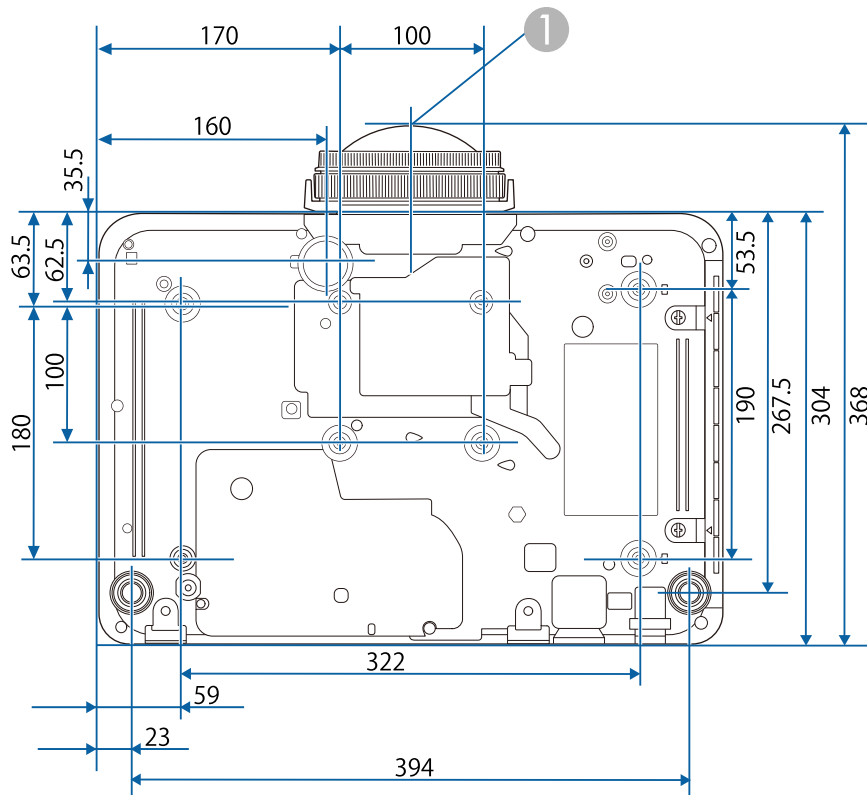
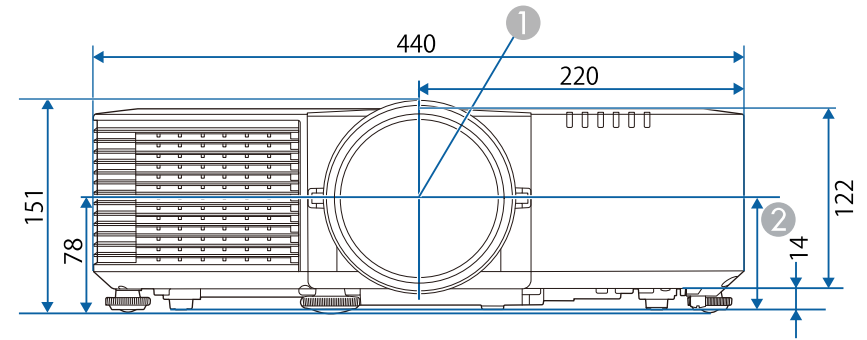
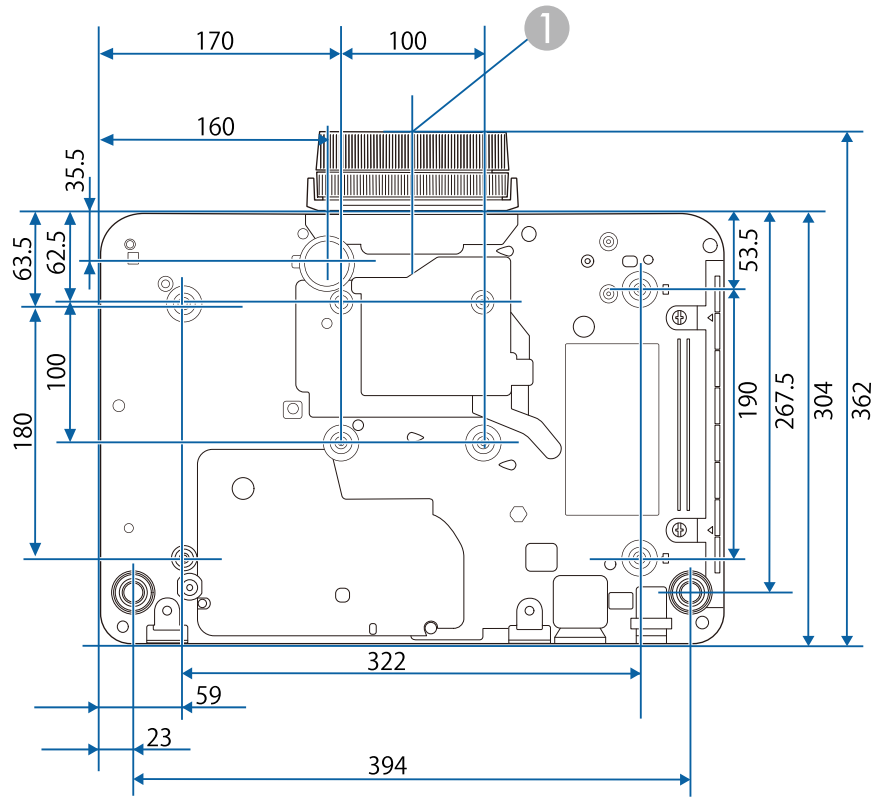

- ① Center of lens
- ② Distance from center of lens to suspension bracket fixing point: 76 mm

EB-L690SE/EB-L695SE

- ① Center of lens
- ② Distance from center of lens to suspension bracket fixing point: 76 mm







The unit in these illustrations is mm.















Your projector supports the following features and options of the Epson Projector Content Manager software.

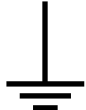



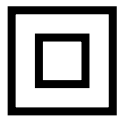

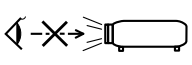

Features/Options		
Simultaneous playback		-
Save the playlist to the projector via a network		✓
<b>Settings &gt; Video Format</b>	Auto Select	✓
	AVI Format	✓
	MP4 Format	-

The following table lists the meaning of the safety symbols labeled on the equipment.

No.	Symbol mark	Approved standards	Description
1		IEC60417 No. 5007	"ON" (power) To indicate connection to the mains.
2		IEC60417 No. 5008	"OFF" (power) To indicate disconnection from the mains.
3		IEC60417 No. 5009	Stand-by To identify the switch or switch position by means of which part of the equipment is switched on in order to bring it into the stand-by condition.
4		ISO7000 No. 0434B, IEC3864-B3.1	Caution To identify general caution when using the product.
5		IEC60417 No. 5041	Caution, hot surface To indicate that the marked item can be hot and should not be touched without taking care.
6		IEC60417 No. 6042 ISO3864-B3.6	Caution, risk of electric shock To identify equipment that has risk of electric shock.
7		IEC60417 No. 5957	For indoor use only To identify electrical equipment designed primarily for indoor use.

No.	Symbol mark	Approved standards	Description
8		IEC60417 No. 5926	Polarity of d.c. power connector To identify the positive and negative connections (the polarity) on a piece of equipment to which a d.c. power supply may be connected.
9		—	The same as No. 8.
10		IEC60417 No. 5001B	Battery, general On battery powered equipment. To identify a device for instance a cover for the battery compartment, or the connector terminals.
11		IEC60417 No. 5002	Positioning of cell To identify the battery holder itself and to identify the positioning of the cell(s) inside the battery holder.
12		—	The same as No. 11.
13		IEC60417 No. 5019	Protective earth To identify any terminal which is intended for connection to an external conductor for protection against electric shock in case of a fault, or the terminal of a protective earth electrode.
14		IEC60417 No. 5017	Earth To identify an earth (ground) terminal in cases where neither the symbol No. 13 is explicitly required.

No.	Symbol mark	Approved standards	Description
15		IEC60417 No. 5032	Alternating current To indicate on the rating plate that the equipment is suitable for alternating current only; to identify relevant terminals.
16		IEC60417 No. 5031	Direct current To indicate on the rating plate that the equipment is suitable for direct current only; to identify relevant terminals.
17		IEC60417 No. 5172	Class II equipment To identify equipment meeting the safety requirements specified for Class II equipment according to IEC 61140.
18		ISO 3864	General prohibition To identify actions or operations that are prohibited.
19		ISO 3864	Contact prohibition To indicate injury that could occur due to touching a specific part of the equipment.
20		—	Never look into the optical lens while the projector is on.
21		—	To indicate that the marked item don't place anything on projector.
22		ISO3864 IEC60825-1	Caution, laser radiation To indicate the equipment has a laser radiation part.

No.	Symbol mark	Approved standards	Description
23		ISO 3864	Disassembly prohibition To indicate a risk of injury, such as electric shock, if the equipment is disassembled.
24		IEC60417 No. 5266	Standby, partial standby To indicate that part of the equipment is in the ready status.
25		ISO3864 IEC60417 No. 5057	Caution, movable parts To indicate that you must keep away from movable parts according to protection standards.
26		IEC60417 No. 6056	Caution (Moving Fan Blades) As a safety precaution, stay away from the moving fan blades.
27		IEC60417 No. 6043	Caution (Sharp Corners) To indicate sharp corners that should not be touched.
28		—	To indicate that looking into the lens while projecting is prohibited.
29		ISO7010 No. W027 ISO 3864	Warning, Optical radiation (such as UV, visible radiation, IR) Taking care to avoid injury to eyes and skin when in the vicinity of optical radiation.
30		IEC60417 No. 5109	Not to be used in residential areas. To identify electrical equipment which is not suitable for a residential area.

This projector is a Class 1 laser product that complies with the IEC60825-1:2014 and EN60825-1:2014 + A11:2021 international standard for lasers.

Follow these safety instructions when using the projector.

## Warning

- This is a class A product. In a domestic environment this product may cause radio interference in which case the user may be required to take adequate measures.
- Do not open the projector's case. The projector contains a high-powered laser.
- Possibly hazardous optical radiation emitted from this product. Do not look at operating light source. Eye injury may result.

## Caution

Do not disassemble the projector when disposing of it. Dispose according to your local or national laws and regulations.



The projector uses a laser as the light source. The laser has the following characteristics.

- Depending on the surroundings, the brightness of the light source may decline. The brightness declines a lot when the temperature gets too high.
- The brightness of the light source declines the longer it is used. You can change the relationship between usage time and decline in brightness settings.

## ▶▶ Related Links

- "Laser Warning Labels" [p.284](#)

## Laser Warning Labels

Laser warning labels are attached on the projector.

### Inside



### Top

As with any bright source, do not stare into the beam, RG2 IEC/EN 62471-5:2015.

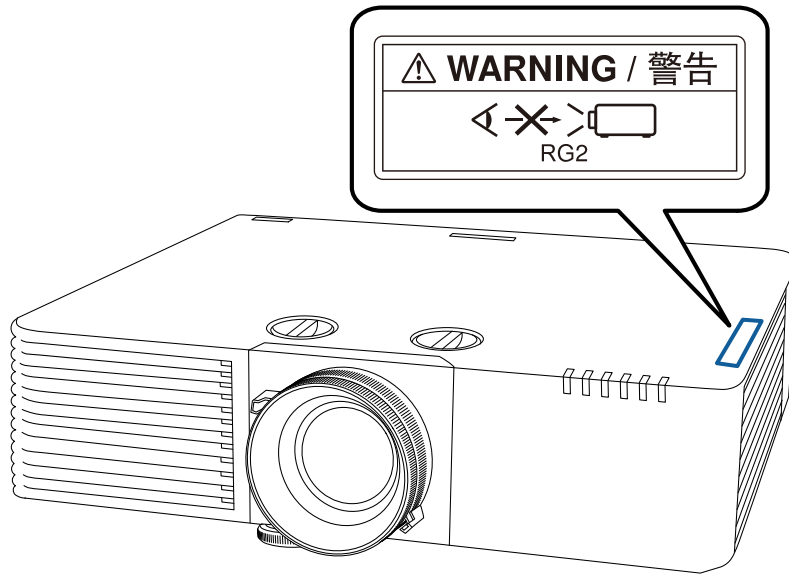

## Warning

- Never look into the projector lens when the laser is on. This can damage your eyes and is especially dangerous for children and pets.
- As with any bright source, do not stare into the beam, RG2 IEC/EN 62471-5:2015.
- When turning on the projector at a distance using the remote control, make sure no one is looking into the lens.
- Do not allow small children to operate the projector. Children must be accompanied by an adult.
- Do not look into the lens during projection. Also, do not look into the lens using optical devices, such as a magnifying glass or telescope. This could cause visual impairment.

## Bottom

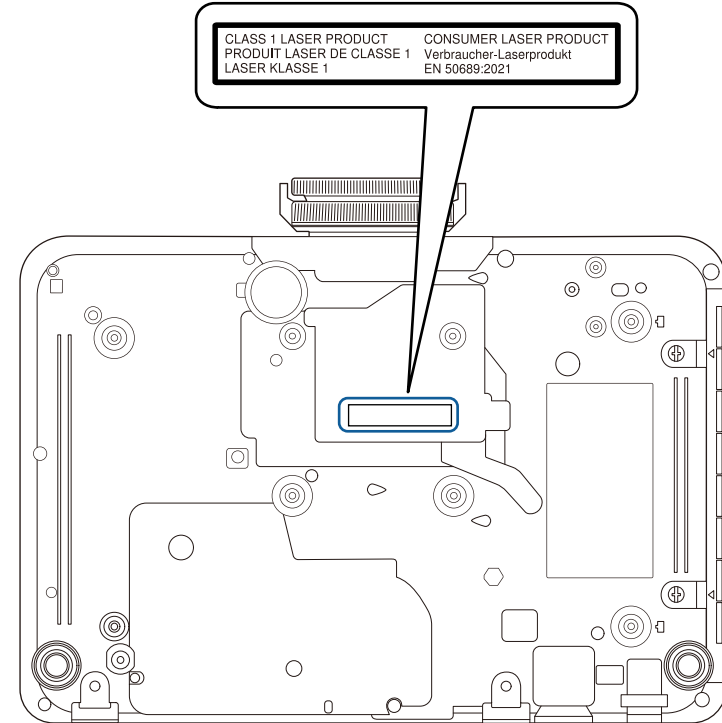

This projector is a consumer Class 1 laser product that complies with EN50689:2021 standard.

This projector is the product that projects images onto walls, screens, etc. The label attached on the projector varies depending on the countries and regions.

Check these sections for important notices about your projector.

► **Related Links**

- "FCC Compliance Statement" [p.286](#)
- "Indication of the manufacturer and the importer in accordance with requirements of EU directive" [p.287](#)
- "TCO Information" [p.287](#)
- "Restriction of Use" [p.288](#)
- "Operating System References" [p.288](#)
- "Trademarks" [p.288](#)
- "Copyright Notice" [p.289](#)
- "Copyright Attribution" [p.289](#)

## FCC Compliance Statement

**Supplier's DECLARATION of CONFORMITY**  
 According to 47CFR, Part 2 and 15  
 Class A digital devices, peripherals & switching power supplies

We: Epson America, Inc.

Located at: 3131 Katella Avenue, Los Alamitos, CA

Tel: 562-981-3840

Declare under sole responsibility that the product identified herein, complies with 47CFR Part 2 and 15 of the FCC rules as a Class A digital device. Each product marketed, is identical to the representative unit tested and found to be compliant with the standards. Records maintained continue to reflect the equipment being produced can be expected to be within the variation accepted, due to quantity production and testing on a statistical basis as required by 47CFR 2.906. Operation is subject to the following two conditions: (1) this device may not cause harmful interference, and (2) this device must accept any interference received, including interference that may cause undesired operation.

Trade Name: EPSON

Type of Product: LCD Projector

Model: EAI destination: HB24A, HB24F, HB25A, HB26A, HB26F, HB27A, HB28A, HB28F, HB29A, HB29F, HB31F, HB31A, HB36A,

Other destination: HB24J, HB25J, HB26J, HB27J, HB28J, HB29J, HB31J, HB36B

Options:

Product name	Model
Remote controller	2234491 xx (x=0-9)

### FCC Compliance Statement For United States Users

This device complies with part 15 of the FCC Rules. Operation is subject to the following two conditions: (1) This device may not cause harmful interference, and (2) this device must accept any interference received, including interference that may cause undesired operation.

This equipment has been tested and found to comply with the limits for a Class A digital device, pursuant to Part 15 of the FCC Rules. These limits are designed to provide reasonable protection against harmful interference when the equipment is operated in commercial environment. This equipment generates, uses, and can radiate radio frequency energy and, if not installed and used in accordance with the instruction manual, may cause harmful interference to radio communications. Operation of this equipment in residential area is likely to cause harmful interference in which case the user will be required to correct the interference at this own expense.

### WARNING

The connection of a non-shielded equipment interface cable to this equipment will invalidate the FCC Certification or Declaration of this device and may cause interference levels which exceed the limits established by the FCC for this equipment. It is the responsibility of the user to obtain and use a shielded equipment interface cable with this device. If this equipment has more than one interface connector, do not leave cables connected to unused interfaces. Changes or modifications not expressly approved by the manufacturer could void the user's authority to operate the equipment.

**Indication of the manufacturer and the importer in accordance with requirements of EU directive**

Manufacturer: SEIKO EPSON CORPORATION  
 Address: 3-5, Owa 3-chome, Suwa-shi, Nagano-ken 392-8502 Japan  
<http://www.epson.com/>

Importer: EPSON EUROPE B.V.  
 EU Address: Atlas Arena, Atlas Arena, Asia Building, Hoogoorddreef 5,1101 BA Amsterdam Zuidoost The Netherlands  
 UK Address: Floor 3&4, The Clarendon Works, 37-39 Clarendon Road, Watford WD17 1JA, U.K.  
<http://www.epson.eu/>

Supplier in Middle East, Turkey, Africa, and Central & West Asia: Epson Middle East FZCO  
 Address: 6WA-401 6W bldg., Dubai Airport Freezone, Dubai, United Arab Emirates  
[www.epson.com/eme](http://www.epson.com/eme)

**TCO Information**

A third-party certification according to ISO 14024



Toward sustainable IT products

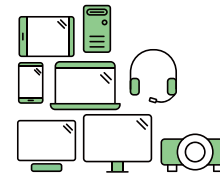

**Say hello to a more sustainable product**

IT products are associated with a wide range of sustainability risks throughout their life cycle. Human rights violations are common in the factories. Harmful substances are used both in products and their manufacture. Products can often have a short lifespan because of poor ergonomics, low quality and when they are not able to be repaired or upgraded.

This product is a better choice . It meets all the criteria in TCO Certified, the world's most comprehensive sustainability certification for IT products. Thank you for making a responsible product choice, that help drive progress towards a more sustainable future!

Criteria in TCO Certified have a life-cycle perspective and balance environmental and social responsibility. Conformity is verified by independent and approved verifiers that specialize in IT products, social responsibility or other sustainability issues. Verification is done both before and after the certificate is issued, covering the entire validity period. The process also includes ensuring that corrective actions are implemented in all cases of factory non-conformities. And last but not least, to make sure that the certification and independent verification is accurate, both TCO Certified and the verifiers are reviewed regularly.

**Want to know more?**

Read information about TCO Certified, full criteria documents, news and updates at [tccertified.com](http://tccertified.com). On the website you'll also find our Product Finder, which presents a complete, searchable listing of certified products.

---

## Restriction of Use

When this product is used for applications requiring high reliability/safety such as transportation devices related to aviation, rail, marine, automotive etc.; disaster prevention devices; various safety devices etc; or functional/precision devices etc, you should use this product only after giving consideration to including fail-safes and redundancies into your design to maintain safety and total system reliability. Because this product was not intended for use in applications requiring extremely high reliability/safety such as aerospace equipment, main communication equipment, nuclear power control equipment, or medical equipment related to direct medical care etc, please make your own judgment on this product's suitability after a full evaluation.

---

## Operating System References

- Microsoft® Windows® 8.1 operating system
- Microsoft® Windows® 10 operating system
- Microsoft® Windows® 11 operating system

In this guide, the operating systems above are referred to as "Windows 8.1", "Windows 10", and "Windows 11". Furthermore, the collective term "Windows" is used to refer to them all.

- macOS 10.13.x
- macOS 10.14.x
- macOS 10.15.x
- macOS 11.0.x
- macOS 12.0.x

In this guide, the collective term "Mac" is used to refer to all of the operating systems above.

---

## Trademarks

App Store is a service mark of Apple Inc., registered in the U.S. and other countries.

Apple, Mac, macOS, AirPlay, Apple Home, Apple TV, HomeKit, HomePod, and HomePod Mini are trademarks of Apple Inc., registered in the U.S. and other countries.

Microsoft, Windows, and Windows Server are trademarks or registered trademarks of Microsoft Corporation in the United States and/or other countries.

Wi-Fi®, WPA2™, WPA3™, and Wi-Fi CERTIFIED Miracast® are trademarks of Wi-Fi Alliance®.

Chrome, Chromebook, and Google Play are trademarks of Google LLC.

The terms HDMI, HDMI High-Definition Multimedia Interface, HDMI Trade dress and the HDMI Logos are trademarks or registered trademarks of HDMI Licensing Administrator, Inc. 

"QR Code" is a registered trademark of DENSO WAVE INCORPORATED.

PJLink trademark is a trademark applied for registration or is already registered in Japan, the United States of America and other countries and areas.

Crestron®, Crestron Connected®, Crestron Fusion®, Crestron Control®, and Crestron RoomView® are registered trademarks of Crestron Electronics, Inc.

Intel® is a registered trademark of Intel Corporation in the U.S. and/or other countries.

Extron® and XTP® are registered trademarks of RGB Systems. Incorporated.

HDBaseT™ and the HDBaseT Alliance logo are trademarks of the HDBaseT Alliance.

The N-Mark is a trademark or registered trademark of NFC Forum, Inc. in the United States and in other countries.

Other product names used herein are also for identification purposes only and may be trademarks of their respective owners. Epson disclaims any and all rights in those marks.



---

## Copyright Notice

All rights reserved. No part of this publication may be reproduced, stored in a retrieval system, or transmitted in any form or by any means, electronic, mechanical, photocopying, recording, or otherwise, without the prior written permission of Seiko Epson Corporation. No patent liability is assumed with respect to the use of the information contained herein. Neither is any liability assumed for damages resulting from the use of the information contained herein.

Neither Seiko Epson Corporation nor its affiliates shall be liable to the purchaser of this product or third parties for damages, losses, costs, or expenses incurred by the purchaser or third parties as a result of: accident, misuse, or abuse of this product or unauthorized modifications, repairs, or alterations to this product, or (excluding the U.S.) failure to strictly comply with Seiko Epson Corporation's operating and maintenance instructions.

Seiko Epson Corporation shall not be liable against any damages or problems arising from the use of any options or any consumable products other than those designated as Original Epson Products or Epson Approved Products by Seiko Epson Corporation.

The contents of this guide may be changed or updated without further notice. Illustrations in this guide and the actual projector may differ.

---

## Copyright Attribution

This information is subject to change without notice.

© 2025 Seiko Epson Corporation

2026.01 414567806 EN