



## PU-1201-KIT

UHD+ HDMI over Category Cable  
Transmitter & Receiver Set

**OPERATION MANUAL**

**HDMI®**  
HIGH-DEFINITION MULTIMEDIA INTERFACE

The terms HDMI, HDMI High-Definition Multimedia Interface, and the HDMI Logo are trademarks or registered trademarks of HDMI Licensing Administrator, Inc.

## **DISCLAIMERS**

The information in this manual has been carefully checked and is believed to be accurate. CYP (UK) Ltd assumes no responsibility for any infringements of patents or other rights of third parties which may result from its use.

CYP (UK) Ltd assumes no responsibility for any inaccuracies that may be contained in this document. CYP (UK) Ltd also makes no commitment to update or to keep current the information contained in this document.

CYP (UK) Ltd reserves the right to make improvements to this document and/or product at any time and without notice.

## **COPYRIGHT NOTICE**

No part of this document may be reproduced, transmitted, transcribed, stored in a retrieval system, or any of its part translated into any language or computer file, in any form or by any means—electronic, mechanical, magnetic, optical, chemical, manual, or otherwise—without express written permission and consent from CYP (UK) Ltd.

© Copyright 2020 by CYP (UK) Ltd.

All Rights Reserved.

Version 1.1

## **TRADEMARK ACKNOWLEDGMENTS**

All products or service names mentioned in this document may be trademarks of the companies with which they are associated.

---



## SAFETY PRECAUTIONS

Please read all instructions before attempting to unpack, install or operate this equipment and before connecting the power supply. Please keep the following in mind as you unpack and install this equipment:

- Always follow basic safety precautions to reduce the risk of fire, electrical shock and injury to persons.
- To prevent fire or shock hazard, do not expose the unit to rain, moisture or install this product near water.
- Never spill liquid of any kind on or into this product.
- Never push an object of any kind into this product through any openings or empty slots in the unit, as you may damage parts inside the unit.
- Do not attach the power supply cabling to building surfaces.
- Use only the supplied power supply unit (PSU). Do not use the PSU if it is damaged.
- Do not allow anything to rest on the power cabling or allow any weight to be placed upon it or any person walk on it.
- To protect the unit from overheating, do not block any vents or openings in the unit housing that provide ventilation and allow for sufficient space for air to circulate around the unit.
- Please completely disconnect the power when the unit is not in use to avoid wasting electricity.

## VERSION HISTORY

REV.	DATE	SUMMARY OF CHANGE
RDV1	2022/08/24	Preliminary release

# CONTENTS

<b>1. Introduction</b> .....	<b>1</b>
<b>2. Applications</b> .....	<b>1</b>
<b>3. Package Contents</b> .....	<b>1</b>
<b>4. System Requirements</b> .....	<b>1</b>
<b>5. Features</b> .....	<b>2</b>
<b>6. Operation Controls and Functions</b> .....	<b>3</b>
6.1 Front Panel .....	3
6.2 Rear Panel.....	4
6.2 Top Panel .....	5
<b>7. Connection Diagram</b> .....	<b>6</b>
<b>8. Specifications</b> .....	<b>7</b>
8.1 Technical Specifications .....	7
8.2 Video Specifications.....	8
8.3 Audio Specifications.....	10
8.3.1 Digital Audio .....	10
8.3.2 Analogue Audio .....	10
8.4 Cable Specifications .....	11
<b>9. Acronyms</b> .....	<b>12</b>

---



## 1. INTRODUCTION

This UHD<sup>+</sup> HDMI over Category Cable Transmitter & Receiver set is an extension system which is able to extend high quality 4K HDMI video along with audio up to 60m (197ft) of standard Cat.6 network cable without signal loss or introducing delay. This receiver unit includes a selectable HDMI input, stereo analogue audio extraction, and is powered directly via PoC (Power over Cable) provided by the connected compatible transmitter unit which includes basic EDID management functionality, an HDMI bypass output, and provides PoC (Power over Cable) to the connected compatible receiver.

## 2. APPLICATIONS

- /// Long distance video and audio extension
- /// Hotel or convention center displays
- /// Lecture halls, auditoriums and classroom
- /// Houses of worship
- /// Conference rooms and boardrooms

## 3. PACKAGE CONTENTS

- /// 1× UHD<sup>+</sup> HDMI over Category Cable Transmitter
- /// 1× UHD<sup>+</sup> HDMI over Category Cable Receiver
- /// 1× 12V/3A DC Power Adapter
- /// 1× Operation Manual

## 4. SYSTEM REQUIREMENTS

- /// HDMI receiving equipment such as an HDTV, monitor, or audio amplifier.
- /// The use of Premium High Speed HDMI cables, and industry standard Cat.6, Cat.6A or Cat.7, is highly recommended.

## 5. FEATURES

- /// HDMI 2.0 and DVI 1.0 compatible
- /// HDCP 2.2 and HDCP 1.x compliant
- /// RX: 1 Cat.6 input, 1 HDMI input, 1 HDMI output
- /// TX: 1 HDMI input, 1 Cat.6 output, 1 HDMI bypass output
- /// Supports HDMI input and Cat.6 output resolutions up to 4K@60Hz (4:4:4, 8-bit)
- /// Cat.6 extension can reach to up to 60m (197ft)
- /// Basic EDID management with 3 built in EDIDs and an EDID bypass option
- /// Supports extension of many audio formats including LPCM (up to 8 channels) and standard Bitstream
- /// Supports stereo analogue audio extraction (LPCM 2.0 sources only)
- /// Top panel LEDs indicate source selection, link state, and power
- /// RX Unit is a PoC (PD) device and is powered by the connected compatible PoC (PSE) transmitter
- /// TX Unit is a PoC (PSE) device and can provide power to a connected compatible receiver

## 6. OPERATION CONTROLS AND FUNCTIONS

### 6.1 TX Front Panel

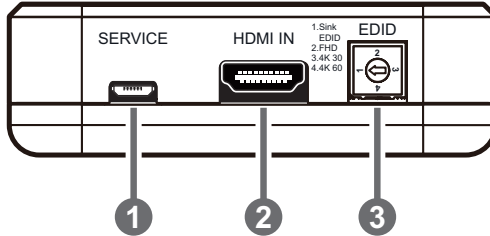

- ❶ **SERVICE Port:** This port is reserved for firmware update use only.
- ❷ **HDMI IN Port:** Connect to HDMI source equipment such as a media player, game console, or set-top box. DVI sources are supported with the use of an HDMI to DVI adapter.
- ❸ **EDID Dial:** Use this dial to select the unit's EDID management mode:
 

1 = Sink EDID	2 = FHD (1080p60) & LPCM 2.0
3 = UHD (4K30) & LPCM 2.0	4 = UHD <sup>+</sup> (4K60) & LPCM 2.0

### 6.2 RX Front Panel

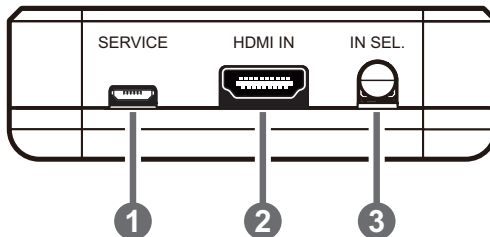

- ❶ **SERVICE Port:** This port is reserved for firmware update use only.
- ❷ **HDMI IN Port:** Connect to HDMI source equipment such as a media player, game console, or set-top box. DVI sources are supported with the use of an HDMI to DVI adapter.
- ❸ **IN SEL Button:** Press this button to toggle between the two available inputs.



### 6.3 TX Rear Panel

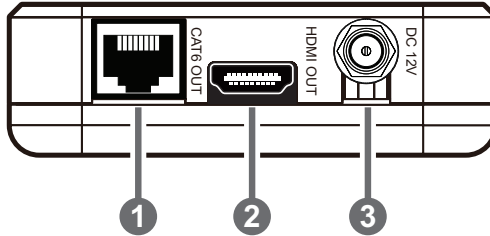

- 1 CAT6 OUT Port:** Connect to a compatible receiver with a single Cat.6, or better, cable for transmission of all data signals. PoC will also be supplied to a connected compatible PD receiver.

*Note: The PoC function is designed to send power to compatible receiver units only. Other brands of receiver may not be compatible.*
- 2 HDMI OUT Port:** Connect to HDMI TVs, monitors, or amplifiers for digital video and audio output.
- 3 DC 12V Port:** Plug the 12V DC power adapter into this port and connect it to an AC wall outlet for power. The top LED will illuminate red to indicate the unit is on and receiving power.

### 6.4 RX Rear Panel

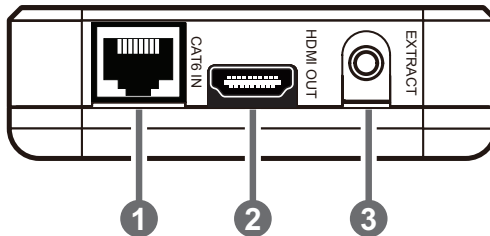

- 1 CAT6 IN Port:** Connect to a compatible Cat.6 transmitter with a single Cat.6, or better, cable for reception of all data signals. Power via PoC is also supplied to this unit by the connected compatible PSE transmitter.

*Note: The PoC function is designed to receiver power from compatible transmitter units only. Other brands of transmitter may not be compatible.*
- 2 HDMI OUT Port:** Connect to HDMI TVs, monitors, or amplifiers for digital video and audio output.

- 3 EXTRACT Port:** Connect to powered speakers, headphones, or an amplifier for analogue stereo audio output.

*Note: Only LPCM 2.0 audio sources are supported. Other audio formats will be automatically muted.*

## 6.5 TX Top Panel

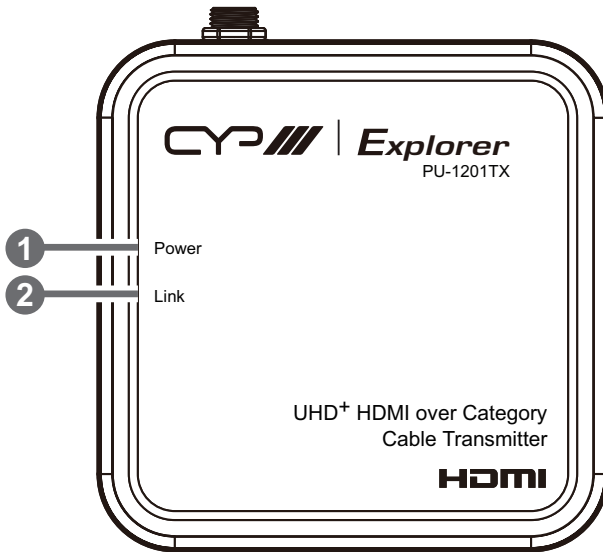

- 1 Power LED:** This LED will illuminate red to indicate the unit is on and receiving power. When the unit is in update mode the LED will blink.
- 2 Link LED:** This LED will illuminate blue to indicate that a live source has been detected on the input port. When no source is detected the LED will remain off.

## 6.6 RX Top Panel

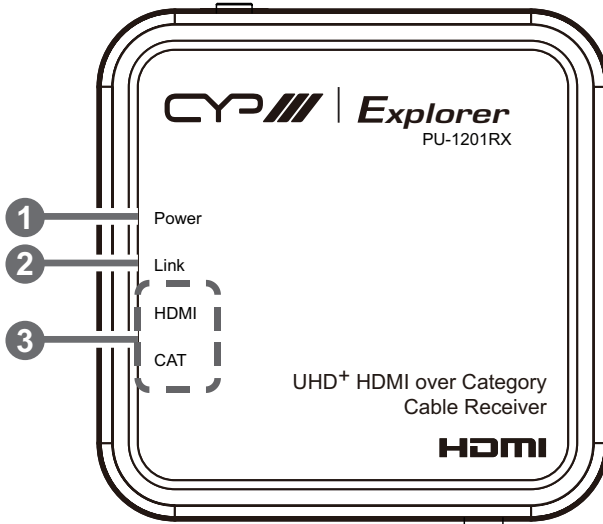

- 1 Power LED:** This LED will illuminate red to indicate the unit is on and receiving power. When the unit is in update mode the LED will blink.
- 2 Link LED:** This LED will illuminate blue to indicate that a live source has been detected on the currently selected input port. When no source is detected the LED will remain off.
- 3 HDMI & CAT LEDs:** The illuminated LED indicates which source is currently selected.

## 7. CONNECTION DIAGRAM

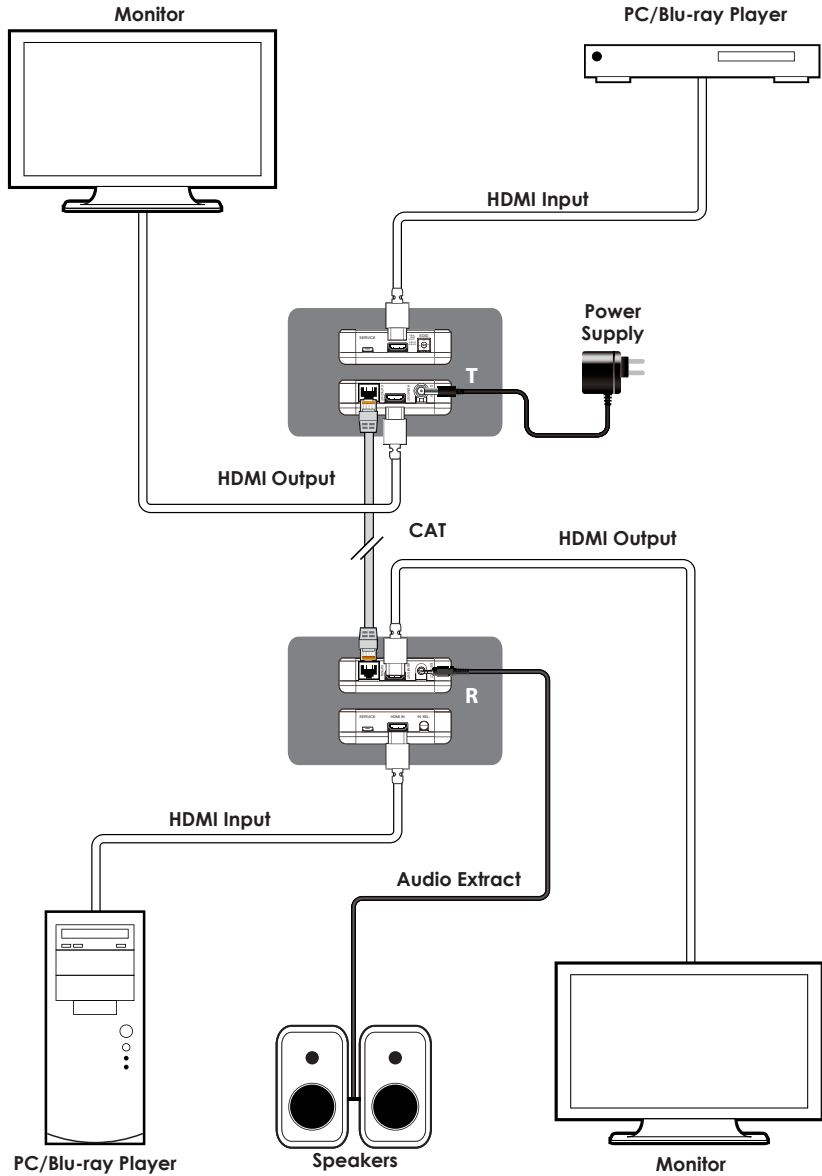

## 8. SPECIFICATIONS

### 8.1 Technical Specifications

<b>HDMI Bandwidth</b>	18Gbps
<b>Cat.6 Bandwidth</b>	10Gbps
<b>Input Ports (TX)</b>	1×HDMI (Type-A)
<b>Input Ports (RX)</b>	1×Cat.6 (RJ-45) 1×HDMI (Type-A)
<b>Output Ports (TX)</b>	1×HDMI (Type-A) 1×Analogue Stereo (3.5mm)
<b>Output Ports (RX)</b>	1×Cat.6 (RJ-45) 1×HDMI (Type-A)
<b>Service Port</b>	1×USB 2.0 (Micro-B)
<b>Power Supply (TX)</b>	12V/3A DC (US/EU standards, CE/FCC/UL certified)
<b>Power Supply (RX)</b>	PoC from Transmitter
<b>ESD Protection (HBM)</b>	±8kV (Air Discharge) ±4kV (Contact Discharge)
<b>Dimensions (W×H×D)</b>	85mm×26mm×85mm [Case Only] 85mm×26mm×91mm [All Inclusive]
<b>Weight</b>	150g
<b>Chassis Material</b>	Plastic
<b>Chassis Colour</b>	Black
<b>Operating Temperature</b>	0°C – 40°C/32°F – 104°F
<b>Storage Temperature</b>	-20°C – 60°C/-4°F – 140°F
<b>Relative Humidity</b>	20 – 90% RH (Non-condensing)
<b>Power Consumption</b>	4.6W (including PoC to receiver)

## 8.2 Video Specifications

Supported Resolutions (Hz)	Input		Output
	Cat.6	HDMI	HDMI
<b>720×400p@70/85</b>	✓	✓	✓
<b>640×480p@60/72/75/85</b>	✓	✓	✓
<b>720×480i@60</b>	✓	✓	✓
<b>720×480p@60</b>	✓	✓	✓
<b>720×576i@50</b>	✓	✓	✓
<b>720×576p@50</b>	✓	✓	✓
<b>800×600p@56/60/72/75/85</b>	✓	✓	✓
<b>848×480p@60</b>	✓	✓	✓
<b>1024×768p@60/70/75/85</b>	✓	✓	✓
<b>1152×864p@75</b>	✓	✓	✓
<b>1280×720p@50/60</b>	✓	✓	✓
<b>1280×768p@60/75/85</b>	✓	✓	✓
<b>1280×800p@60/75/85</b>	✓	✓	✓
<b>1280×800p@60RB</b>	x	✓	✓
<b>1280×960p@60/85</b>	✓	✓	✓
<b>1280×1024p@60/75/85</b>	✓	✓	✓
<b>1360×768p@60</b>	✓	✓	✓
<b>1366×768p@60</b>	✓	✓	✓
<b>1400×1050p@60</b>	✓	✓	✓
<b>1400×1050p@60RB</b>	x	✓	✓
<b>1440×900p@60/75</b>	✓	✓	✓
<b>1440×900p@60RB</b>	x	✓	✓
<b>1600×900p@60RB</b>	x	✓	✓
<b>1600×1200p@60</b>	✓	✓	✓

Supported Resolutions (Hz)	Input		Output
	Cat.6	HDMI	HDMI
<b>1680×1050p@60</b>	✓	✓	✓
<b>1920×1080i@50/60</b>	x	✓	✓
<b>1920×1080p@24/25/30</b>	✓	✓	✓
<b>1920×1080p@50/60</b>	✓	✓	✓
<b>1920×1200p@60</b>	✓	✓	✓
<b>1920×1200p@60RB</b>	x	✓	✓
<b>2560×1440p@60RB</b>	x	✓	✓
<b>2560×1600p@60RB</b>	x	✓	✓
<b>2048×1080p@24/25/30</b>	x	✓	✓
<b>2048×1080p@50/60</b>	x	✓	✓
<b>3840×2160p@24/25/30</b>	✓	✓	✓
<b>3840×2160p@50/60 (4:2:0)</b>	✓	✓	✓
<b>3840×2160p@24, HDR10</b>	x	✓	✓
<b>3840×2160p@50/60 (4:2:0), HDR10</b>	x	✓	✓
<b>3840×2160p@50/60</b>	✓	✓	✓
<b>4096×2160p@24/25/30</b>	✓	✓	✓
<b>4096×2160p@50/60 (4:2:0)</b>	<b>50</b>	✓	✓
<b>4096×2160p@24, HDR10</b>	x	✓	✓
<b>4096×2160p@50/60 (4:2:0), HDR10</b>	x	✓	✓
<b>4096×2160p@50/60</b>	<b>50</b>	✓	✓

## 8.3 Audio Specifications

### 8.3.1 Digital Audio

HDMI Input / Output	
LPCM	
<b>Max Channels</b>	8 Channels
<b>Sampling Rate (kHz)</b>	32, 44.1, 48, 88.2, 96, 176.4, 192
Bitstream	
<b>Supported Formats</b>	Standard

Cat.6 Input	
LPCM	
<b>Max Channels</b>	8 Channels
<b>Sampling Rate (kHz)</b>	32, 44.1, 48, 88.2, 96, 176.4, 192
Bitstream	
<b>Supported Formats</b>	Standard

### 8.3.2 Analogue Audio

Analogue Output	
<b>Max Audio Level</b>	2Vrms
<b>THD+N</b>	< -40dB@0dBFS 1kHz (A-wt)
<b>SNR</b>	> 70dB@0dBFS
<b>Frequency Response</b>	< ±3dB@20Hz~20kHz
<b>Crosstalk</b>	< -80dB@10kHz
<b>Impedance</b>	4Ω
<b>Type</b>	Unbalanced



## 8.4 Cable Specifications

Cable Length	HD	FHD	4K UHD	4K UHD <sup>+</sup>	8K UHD
<b>High Speed HDMI Cable</b>					
<b>HDMI Input</b>	10m	10m	5m	3m	×
<b>HDMI Output</b>	10m	10m	5m	3m	×
<b>Ethernet Cable</b>					
<b>Cat.6/6A/7</b>	60m				×

### Bandwidth Category Examples:

#### HD Video

- 720p@60Hz
- HDMI transmission rates lower than 3Gbps
- HD-SDI (SMPTE 292M, 1.485Gbps)

#### FHD Video

- 1080p@60Hz
- HDMI transmission rates between 3Gbps and 5.3Gbps
- 3G-SDI (SMPTE 424M, 2.970Gbps)

#### 4K UHD Video

- 4K@24/25/30Hz (8-bit color) & 4K@50/60Hz (4:2:0, 8-bit color)
- HDMI transmission rates between 5.3Gbps and 10.2Gbps
- 6G-SDI (SMPTE ST 2081, 6Gbps)

#### 4K UHD<sup>+</sup> Video

- 1080p@120Hz (10/12-bit HDR)
- 4K@50/60Hz (4:4:4, 8-bit) & 4K@50/60Hz (4:2:0, 10/12-bit HDR)
- HDMI transmission rates between 10.2Gbps and 18Gbps
- 12G-SDI (SMPTE ST 2082, 12Gbps)

#### 8K UHD Video

- 4K@120Hz (10/12-bit HDR)
- 8K@24/25/30Hz (10/12-bit HDR) & 8K@50/60Hz (4:2:0, 8-bit color)
- HDMI transmission rates between 18Gbps and 48Gbps
- 24G-SDI (SMPTE ST 2083, 24Gbps)

## 9. ACRONYMS

ACRONYM	COMPLETE TERM
<b>4K UHD</b>	4K Ultra-High-Definition (10.2Gbps max)
<b>4K UHD<sup>+</sup></b>	4K Ultra-High-Definition (18Gbps max)
<b>8K UHD</b>	8K Ultra-High-Definition (48Gbps max, without DSC)
<b>8K UHD<sup>+</sup></b>	8K Ultra-High-Definition (48Gbps max, with DSC)
<b>Cat.5e</b>	Enhanced Category 5 cable
<b>Cat.6</b>	Category 6 cable
<b>Cat.6A</b>	Augmented Category 6 cable
<b>Cat.7</b>	Category 7 cable
<b>DAC</b>	Digital-to-Analogue Converter
<b>dB</b>	Decibel
<b>DVI</b>	Digital Visual Interface
<b>EDID</b>	Extended Display Identification Data
<b>Gbps</b>	Gigabits per second
<b>HDCP</b>	High-bandwidth Digital Content Protection
<b>HDMI</b>	High-Definition Multimedia Interface
<b>HDR</b>	High Dynamic Range
<b>kHz</b>	Kilohertz
<b>LED</b>	Light-Emitting Diode
<b>LPCM</b>	Linear Pulse-Code Modulation
<b>MHz</b>	Megahertz
<b>PD</b>	Powered Device
<b>PoC</b>	Power over Cable
<b>PSE</b>	Power Sourcing Equipment
<b>SNR</b>	Signal-to-Noise Ratio
<b>THD+N</b>	Total Harmonic Distortion plus Noise

<b>ACRONYM</b>	<b>COMPLETE TERM</b>
<b>TMDS</b>	Transition-Minimised Differential Signaling
<b>UHDTV</b>	Ultra-High-Definition Television
<b>USB</b>	Universal Serial Bus
<b>VGA</b>	Video Graphics Array
<b>WUXGA (RB)</b>	Widescreen Ultra Extended Graphics Array (Reduced Blanking)
<b>XGA</b>	Extended Graphics Array
<b>Ω</b>	Ohm



---

CYP (UK) Ltd., Unit 7, Shepperton Business Park, Govett Avenue,  
Shepperton, Middlesex, TW17 8BA

Tel: +44 (0) 20 3137 9180 | Fax: +44 (0) 20 3137 6279

Email: [sales@cypeurope.com](mailto:sales@cypeurope.com)

[www.cypeurope.com](http://www.cypeurope.com)

RDV1